

ADR360/ADR361/ADR363/ADR364/ADR365/ADR366

FEATURES

- Compact TSOT-23-5 packages**
- Low temperature coefficient**
 - B grade: 9 ppm/°C**
 - A grade: 25 ppm/°C**
- Initial accuracy**
 - B grade: ±3 mV maximum**
 - A grade: ±6 mV maximum**
- Ultralow output noise: 6.8 μV p-p (0.1 Hz to 10 Hz)**
- Low dropout: 300 mV**
- Low supply current: 190 μA maximum**
- No external capacitor required**
- Output current: +5 mA/−1 mA**
- Wide temperature range: −40°C to +125°C**

APPLICATIONS

- Battery-powered instrumentations**
- Portable medical instrumentations**
- Data acquisition systems**
- Industrial process controls**
- Automotive**

GENERAL DESCRIPTION

The ADR360/ADR361/ADR363/ADR364/ADR365/ADR366 are precision 2.048 V, 2.5 V, 3.0 V, 4.096 V, 5.0 V, and 3.3 V band gap voltage references that feature low power, high precision in tiny footprints. Using Analog Devices' patented temperature drift curvature correction techniques, the ADR36x references achieve a low temperature drift of 9 ppm/°C in the TSOT package.

The ADR36x family of micropower, low dropout voltage references provides a stable output voltage from a minimum supply of 300 mV above the output. Their advanced design eliminates the need for external capacitors, which further reduces board space and system cost. The combination of low power operation, small size, and ease of use makes the ADR36x precision voltage references ideally suited for battery-operated applications.

Rev. A

Information furnished by Analog Devices is believed to be accurate and reliable. However, no responsibility is assumed by Analog Devices for its use, nor for any infringements of patents or other rights of third parties that may result from its use. Specifications subject to change without notice. No license is granted by implication or otherwise under any patent or patent rights of Analog Devices. Trademarks and registered trademarks are the property of their respective owners.

PIN CONFIGURATION

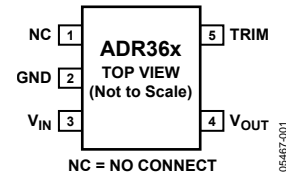

Figure 1. 5-Lead TSOT (UJ Suffix)

Table 1.

Model	V _{OUT} (V) ¹	Temperature Coefficient (ppm/°C)	Accuracy (mV)
ADR360B	2.048	9	±3
ADR360A	2.048	25	±6
ADR361B	2.5	9	±3
ADR361A	2.5	25	±6
ADR363B	3.0	9	±3
ADR363A	3.0	25	±6
ADR364B	4.096	9	±4
ADR364A	4.096	25	±8
ADR365B	5.0	9	±4
ADR365A	5.0	25	±8
ADR366B	3.3	9	±4
ADR366A	3.3	25	±8

¹ Contact Analog Devices, Inc. for other voltage options.

TABLE OF CONTENTS

Features	1	Thermal Resistance	9
Applications.....	1	ESD Caution.....	9
Pin Configuration.....	1	Terminology	10
General Description	1	Typical Performance Characteristics	11
Revision History	2	Theory of Operation	16
ADR360—Specifications	3	Device Power Dissipation Considerations.....	16
ADR361—Specifications	4	Input Capacitor.....	16
ADR363—Specifications	5	Output Capacitor.....	16
ADR364—Specifications	6	Applications.....	17
ADR365—Specifications	7	Basic Voltage Reference Connection	17
ADR366—Specifications	8	Outline Dimensions	19
Absolute Maximum Ratings.....	9	Ordering Guide	19

REVISION HISTORY

3/06—Rev. 0 to Rev. A

Changes to Figure 15 Caption.....	13
Changes to Figure 21 Caption.....	14
Changes to Theory of Operation Section.....	16
Changes to Figure 36.....	18

4/05—Revision 0: Initial Version

ADR360—SPECIFICATIONS

Electrical Characteristics ($V_{IN} = 2.35\text{ V to }15\text{ V}$, $T_A = 25^\circ\text{C}$, unless otherwise noted.)

Table 2.

Parameter	Symbol	Conditions	Min	Typ	Max	Unit
OUTPUT VOLTAGE	V_O	A Grade	2.042	2.048	2.054	V
		B Grade	2.045	2.048	2.051	V
INITIAL ACCURACY	V_{OERR}	A Grade			6	mV
		A Grade			0.29	%
		B Grade			3	mV
		B Grade			0.15	%
		B Grade			25	ppm/°C
TEMPERATURE COEFFICIENT	TCV_O	A Grade, $-40^\circ\text{C} < T_A < +125^\circ\text{C}$ B Grade, $-40^\circ\text{C} < T_A < +125^\circ\text{C}$			9	ppm/°C
SUPPLY VOLTAGE HEADROOM	$V_{IN} - V_O$		300			mV
LINE REGULATION	$\Delta V_O / \Delta V_{IN}$	$V_{IN} = 2.45\text{ V to }15\text{ V}$, $-40^\circ\text{C} < T_A < +125^\circ\text{C}$			0.105	mV/V
LOAD REGULATION	$\Delta V_O / \Delta I_{LOAD}$	$I_{LOAD} = 0\text{ mA to }5\text{ mA}$, $-40^\circ\text{C} < T_A < +125^\circ\text{C}$, $V_{IN} = 3\text{ V}$			0.37	mV/mA
		$I_{LOAD} = -1\text{ mA to }0\text{ mA}$, $-40^\circ\text{C} < T_A < +125^\circ\text{C}$, $V_{IN} = 3\text{ V}$			0.82	mV/mA
QUIESCENT CURRENT	I_{IN}	$-40^\circ\text{C} < T_A < +125^\circ\text{C}$		150	190	μA
VOLTAGE NOISE	$e_{N\text{ p-p}}$	0.1 Hz to 10 Hz		6.8		$\mu\text{V p-p}$
TURN-ON SETTLING TIME	t_R			25		μs
LONG-TERM STABILITY ¹	ΔV_O	1,000 hours		50		ppm
OUTPUT VOLTAGE HYSTERESIS	ΔV_{O_HYS}			100		ppm
RIPPLE REJECTION RATIO	RRR	$f_{IN} = 60\text{ kHz}$		70		dB
SHORT CIRCUIT TO GND	I_{SC}	$V_{IN} = 5\text{ V}$		25		mA
		$V_{IN} = 15\text{ V}$		30		mA

¹ The long-term stability specification is noncumulative. The drift subsequent 1,000 hour periods are significantly lower than in the first 1,000 hour period.

ADR360/ADR361/ADR363/ADR364/ADR365/ADR366

ADR361—SPECIFICATIONS

Electrical Characteristics ($V_{IN} = 2.8\text{ V to }15\text{ V}$, $T_A = 25^\circ\text{C}$, unless otherwise noted.)

Table 3.

Parameter	Symbol	Conditions	Min	Typ	Max	Unit
OUTPUT VOLTAGE	V_O	A Grade	2.494	2.500	2.506	V
		B Grade	2.497	2.500	2.503	V
INITIAL ACCURACY	V_{OERR}	A Grade			6	mV
		A Grade			0.24	%
		B Grade			3	mV
		B Grade			0.12	%
TEMPERATURE COEFFICIENT	TCV_O	A Grade, $-40^\circ\text{C} < T_A < +125^\circ\text{C}$			25	ppm/ $^\circ\text{C}$
		B Grade, $-40^\circ\text{C} < T_A < +125^\circ\text{C}$			9	ppm/ $^\circ\text{C}$
SUPPLY VOLTAGE HEADROOM	$V_{IN} - V_O$		300			mV
LINE REGULATION	$\Delta V_O / \Delta V_{IN}$	$V_{IN} = 2.8\text{ V to }15\text{ V}$, $-40^\circ\text{C} < T_A < +125^\circ\text{C}$			0.125	mV/V
LOAD REGULATION	$\Delta V_O / \Delta I_{LOAD}$	$I_{LOAD} = 0\text{ mA to }5\text{ mA}$, $-40^\circ\text{C} < T_A < +125^\circ\text{C}$, $V_{IN} = 3.5\text{ V}$			0.45	mV/mA
		$I_{LOAD} = -1\text{ mA to }0\text{ mA}$, $-40^\circ\text{C} < T_A < +125^\circ\text{C}$, $V_{IN} = 3.5\text{ V}$			1	mV/mA
QUIESCENT CURRENT	I_{IN}	$-40^\circ\text{C} < T_A < +125^\circ\text{C}$		150	190	μA
VOLTAGE NOISE	$e_{N\text{ p-p}}$	0.1 Hz to 10 Hz		8.25		$\mu\text{V p-p}$
TURN-ON SETTLING TIME	t_R			25		μs
LONG-TERM STABILITY ¹	ΔV_O	1,000 hours		50		ppm
OUTPUT VOLTAGE HYSTERESIS	ΔV_{O_HYS}			100		ppm
RIPPLE REJECTION RATIO	RRR	$f_{IN} = 60\text{ kHz}$		70		dB
SHORT CIRCUIT TO GND	I_{SC}	$V_{IN} = 5\text{ V}$		25		mA
		$V_{IN} = 15\text{ V}$		30		mA

¹ The long-term stability specification is noncumulative. The drift subsequent 1,000 hour periods are significantly lower than in the first 1,000 hour period.

ADR363—SPECIFICATIONS

Electrical Characteristics ($V_{IN} = 3.3\text{ V to }15\text{ V}$, $T_A = 25^\circ\text{C}$, unless otherwise noted.)

Table 4.

Parameter	Symbol	Conditions	Min	Typ	Max	Unit
OUTPUT VOLTAGE	V_O	A Grade	2.994	3.000	3.006	V
		B Grade	2.997	3.000	3.003	V
INITIAL ACCURACY	V_{OERR}	A Grade			6	mV
		A Grade			0.2	%
		B Grade			3	mV
		B Grade			0.1	%
		B Grade			25	ppm/°C
TEMPERATURE COEFFICIENT	TCV_O	A Grade, $-40^\circ\text{C} < T_A < +125^\circ\text{C}$ B Grade, $-40^\circ\text{C} < T_A < +125^\circ\text{C}$			9	ppm/°C
SUPPLY VOLTAGE HEADROOM	$V_{IN} - V_O$		300			mV
LINE REGULATION	$\Delta V_O / \Delta V_{IN}$	$V_{IN} = 3.3\text{ V to }15\text{ V}$, $-40^\circ\text{C} < T_A < +125^\circ\text{C}$			0.15	mV/V
LOAD REGULATION	$\Delta V_O / \Delta I_{LOAD}$	$I_{LOAD} = 0\text{ mA to }5\text{ mA}$, $-40^\circ\text{C} < T_A < +125^\circ\text{C}$, $V_{IN} = 4\text{ V}$			0.54	mV/mA
		$I_{LOAD} = -1\text{ mA to }0\text{ mA}$, $-40^\circ\text{C} < T_A < +125^\circ\text{C}$, $V_{IN} = 4\text{ V}$			1.2	mV/mA
QUIESCENT CURRENT	I_{IN}	$-40^\circ\text{C} < T_A < +125^\circ\text{C}$		150	190	μA
VOLTAGE NOISE	$e_{N\text{ p-p}}$	0.1 Hz to 10 Hz		8.7		$\mu\text{V p-p}$
TURN-ON SETTLING TIME	t_R			25		μs
LONG-TERM STABILITY ¹	ΔV_O	1,000 hours		50		ppm
OUTPUT VOLTAGE HYSTERESIS	ΔV_{O_HYS}			100		ppm
RIPPLE REJECTION RATIO	RRR	$f_{IN} = 60\text{ kHz}$		70		dB
SHORT CIRCUIT TO GND	I_{SC}	$V_{IN} = 5\text{ V}$		25		mA
		$V_{IN} = 15\text{ V}$		30		mA

¹ The long-term stability specification is noncumulative. The drift subsequent 1,000 hour periods are significantly lower than in the first 1,000 hour period.

ADR360/ADR361/ADR363/ADR364/ADR365/ADR366

ADR364—SPECIFICATIONS

Electrical Characteristics ($V_{IN} = 4.4\text{ V}$ to 15 V , $T_A = 25^\circ\text{C}$, unless otherwise noted.)

Table 5.

Parameter	Symbol	Conditions	Min	Typ	Max	Unit
OUTPUT VOLTAGE	V_O	A Grade	4.088	4.096	4.104	V
		B Grade	4.092	4.096	4.100	V
INITIAL ACCURACY	V_{OERR}	A Grade			8	mV
		A Grade			0.2	%
		B Grade			4	mV
		B Grade			0.1	%
TEMPERATURE COEFFICIENT	TCV_O	A Grade, $-40^\circ\text{C} < T_A < +125^\circ\text{C}$			25	ppm/ $^\circ\text{C}$
		B Grade, $-40^\circ\text{C} < T_A < +125^\circ\text{C}$			9	ppm/ $^\circ\text{C}$
SUPPLY VOLTAGE HEADROOM	$V_{IN} - V_O$		300			mV
LINE REGULATION	$\Delta V_O / \Delta V_{IN}$	$V_{IN} = 4.4\text{ V}$ to 15 V , $-40^\circ\text{C} < T_A < +125^\circ\text{C}$			0.205	mV/V
LOAD REGULATION	$\Delta V_O / \Delta I_{LOAD}$	$I_{LOAD} = 0\text{ mA}$ to 5 mA , $-40^\circ\text{C} < T_A < +125^\circ\text{C}$, $V_{IN} = 5\text{ V}$			0.735	mV/mA
		$I_{LOAD} = -1\text{ mA}$ to 0 mA , $-40^\circ\text{C} < T_A < +125^\circ\text{C}$, $V_{IN} = 5\text{ V}$			1.75	mV/mA
QUIESCENT CURRENT	I_{IN}	$-40^\circ\text{C} < T_A < +125^\circ\text{C}$		150	190	μA
VOLTAGE NOISE	$e_{N\text{ p-p}}$	0.1 Hz to 10 Hz		11		$\mu\text{V p-p}$
TURN-ON SETTLING TIME	t_R			25		μs
LONG-TERM STABILITY ¹	ΔV_O	1,000 hours		50		ppm
OUTPUT VOLTAGE HYSTERESIS	ΔV_{O_HYS}			100		ppm
RIPPLE REJECTION RATIO	RRR	$f_{IN} = 60\text{ kHz}$		70		dB
SHORT CIRCUIT TO GND	I_{SC}	$V_{IN} = 5\text{ V}$		25		mA
		$V_{IN} = 15\text{ V}$		30		mA

¹ The long-term stability specification is noncumulative. The drift subsequent 1,000 hour periods are significantly lower than in the first 1,000 hour period.

ADR365—SPECIFICATIONS

Electrical Characteristics ($V_{IN} = 5.3 \text{ V to } 15 \text{ V}$, $T_A = 25^\circ\text{C}$, unless otherwise noted.)

Table 6.

Parameter	Symbol	Conditions	Min	Typ	Max	Unit
OUTPUT VOLTAGE	V_O	A Grade	4.992	5.000	5.008	V
		B Grade	4.996	5.000	5.004	V
INITIAL ACCURACY	V_{OERR}	A Grade			8	mV
		A Grade			0.16	%
		B Grade			4	mV
		B Grade			0.08	%
TEMPERATURE COEFFICIENT	TCV_O	A Grade, $-40^\circ\text{C} < T_A < +125^\circ\text{C}$			25	ppm/ $^\circ\text{C}$
		B Grade, $-40^\circ\text{C} < T_A < +125^\circ\text{C}$			9	ppm/ $^\circ\text{C}$
SUPPLY VOLTAGE HEADROOM	$V_{IN} - V_O$		300			mV
LINE REGULATION	$\Delta V_O / \Delta V_{IN}$	$V_{IN} = 5.3 \text{ V to } 15 \text{ V}$, $-40^\circ\text{C} < T_A < +125^\circ\text{C}$			0.25	mV/V
LOAD REGULATION	$\Delta V_O / \Delta I_{LOAD}$	$I_{LOAD} = 0 \text{ mA to } 5 \text{ mA}$, $-40^\circ\text{C} < T_A < +125^\circ\text{C}$, $V_{IN} = 6 \text{ V}$			0.9	mV/mA
		$I_{LOAD} = -1 \text{ mA to } 0 \text{ mA}$, $-40^\circ\text{C} < T_A < +125^\circ\text{C}$, $V_{IN} = 6 \text{ V}$			2	mV/mA
QUIESCENT CURRENT	I_{IN}	$-40^\circ\text{C} < T_A < +125^\circ\text{C}$		150	190	μA
VOLTAGE NOISE	$e_{N\text{ p-p}}$	0.1 Hz to 10 Hz		12.8		$\mu\text{V p-p}$
TURN-ON SETTLING TIME	t_R			20		μs
LONG-TERM STABILITY ¹	ΔV_O	1,000 hours		50		ppm
OUTPUT VOLTAGE HYSTERESIS	ΔV_{O_HYS}			100		ppm
RIPPLE REJECTION RATIO	RRR	$f_{IN} = 60 \text{ kHz}$		70		dB
SHORT CIRCUIT TO GND	I_{SC}	$V_{IN} = 5 \text{ V}$		25		mA
		$V_{IN} = 15 \text{ V}$		30		mA

¹ The long-term stability specification is noncumulative. The drift subsequent 1,000 hour periods are significantly lower than in the first 1,000 hour period.

ADR360/ADR361/ADR363/ADR364/ADR365/ADR366

ADR366—SPECIFICATIONS

Electrical Characteristics ($V_{IN} = 3.6\text{ V to }15\text{ V}$, $T_A = 25^\circ\text{C}$, unless otherwise noted.)

Table 7.

Parameter	Symbol	Conditions	Min	Typ	Max	Unit
OUTPUT VOLTAGE	V_O	A Grade	3.292	3.300	3.308	V
		B Grade	3.296	3.300	3.304	V
INITIAL ACCURACY	V_{OERR}	A Grade			8	mV
		A Grade			0.25	%
		B Grade			4	mV
		B Grade			0.125	%
TEMPERATURE COEFFICIENT	TCV_O	A Grade, $-40^\circ\text{C} < T_A < +125^\circ\text{C}$			25	ppm/ $^\circ\text{C}$
		B Grade, $-40^\circ\text{C} < T_A < +125^\circ\text{C}$			9	ppm/ $^\circ\text{C}$
SUPPLY VOLTAGE HEADROOM	$V_{IN} - V_O$		300			mV
LINE REGULATION	$\Delta V_O / \Delta V_{IN}$	$V_{IN} = 3.6\text{ V to }15\text{ V}$, $-40^\circ\text{C} < T_A < +125^\circ\text{C}$			0.165	mV/V
LOAD REGULATION	$\Delta V_O / \Delta I_{LOAD}$	$I_{LOAD} = 0\text{ mA to }5\text{ mA}$, $-40^\circ\text{C} < T_A < +125^\circ\text{C}$, $V_{IN} = 4.2\text{ V}$			0.6	mV/mA
		$I_{LOAD} = -1\text{ mA to }0\text{ mA}$, $-40^\circ\text{C} < T_A < +125^\circ\text{C}$, $V_{IN} = 4.2\text{ V}$			1.35	mV/mA
QUIESCENT CURRENT	I_{IN}	$-40^\circ\text{C} < T_A < +125^\circ\text{C}$		150	190	μA
VOLTAGE NOISE	$e_{N\text{ p-p}}$	0.1 Hz to 10 Hz		9.3		$\mu\text{V p-p}$
TURN-ON SETTLING TIME	t_R			25		μs
LONG-TERM STABILITY ¹	ΔV_O	1,000 hours		50		ppm
OUTPUT VOLTAGE HYSTERESIS	ΔV_{O_HYS}			100		ppm
RIPPLE REJECTION RATIO	RRR	$f_{IN} = 60\text{ kHz}$		70		dB
SHORT CIRCUIT TO GND	I_{SC}	$V_{IN} = 5\text{ V}$		25		mA
		$V_{IN} = 15\text{ V}$		30		mA

¹ The long-term stability specification is noncumulative. The drift subsequent 1,000 hour periods are significantly lower than in the first 1,000 hour period.

ABSOLUTE MAXIMUM RATINGS

T_A = 25°C, unless otherwise noted.

Table 8.

Parameter	Rating
Supply Voltage	18 V
Output Short-Circuit Duration to GND	
V _{IN} < 15 V	Indefinite
V _{IN} > 15 V	10 sec
Storage Temperature Range	-65°C to +125°C
Operating Temperature Range	-40°C to +125°C
Junction Temperature Range	-65°C to +125°C
Lead Temperature (Soldering, 60 sec)	300°C

Stresses above those listed under Absolute Maximum Ratings may cause permanent damage to the device. This is a stress rating only; functional operation of the device at these or any other conditions above those indicated in the operational section of this specification is not implied. Exposure to absolute maximum rating conditions for extended periods may affect device reliability.

THERMAL RESISTANCE

θ_{JA} is specified for the worst-case conditions, that is, a device soldered in a circuit board for surface-mount packages.

Table 9. Thermal Resistance

Package Type	θ _{JA}	θ _{JC}	Unit
TSOT-23-5 (UJ-5)	230	146	°C/W

ESD CAUTION

ESD (electrostatic discharge) sensitive device. Electrostatic charges as high as 4000 V readily accumulate on the human body and test equipment and can discharge without detection. Although this product features proprietary ESD protection circuitry, permanent damage may occur on devices subjected to high energy electrostatic discharges. Therefore, proper ESD precautions are recommended to avoid performance degradation or loss of functionality.



TERMINOLOGY

Temperature Coefficient

The change of output voltage with respect to operating temperature changes normalized by the output voltage at 25°C. This parameter is expressed in ppm/°C and can be determined by

$$TCV_o[\text{ppm}/^\circ\text{C}] = \frac{V_o(T_2) - V_o(T_1)}{V_o(25^\circ\text{C}) \times (T_2 - T_1)} \times 10^6$$

where:

$V_o(25^\circ\text{C}) = V_o$ at 25°C.

$V_o(T_1) = V_o$ at Temperature 1.

$V_o(T_2) = V_o$ at Temperature 2.

Line Regulation

The change in output voltage due to a specified change in input voltage. This parameter accounts for the effects of self-heating. Line regulation is expressed in either percent per volt, parts-per-million per volt, or microvolts per volt change in input voltage.

Load Regulation

The change in output voltage due to a specified change in load current. This parameter accounts for the effects of self-heating. Load regulation is expressed in either microvolts per milliampere, parts-per-million per milliampere, or ohms of dc output resistance.

Long-Term Stability

Typical shift of output voltage at 25°C on a sample of parts subjected to a test of 1,000 hours at 25°C.

$$\Delta V_o = V_o(t_0) - V_o(t_1)$$

$$\Delta V_o[\text{ppm}] = \left(\frac{V_o(t_0) - V_o(t_1)}{V_o(t_0)} \times 10^6 \right)$$

where:

$V_o(t_0) = V_o$ at 25°C at Time 0.

$V_o(t_1) = V_o$ at 25°C after 1,000 hours operation at 25°C.

Thermal Hysteresis

The change of output voltage after the device is cycled through temperature from +25°C to -40°C to +125°C and back to +25°C. This is a typical value from a sample of parts put through such a cycle.

$$V_{o_HYS} = V_o(25^\circ\text{C}) - V_{o_TC}$$

$$V_{o_HYS}[\text{ppm}] = \frac{V_o(25^\circ\text{C}) - V_{o_TC}}{V_o(25^\circ\text{C})} \times 10^6$$

where:

$V_o(25^\circ\text{C}) = V_o$ at 25°C.

$V_{o_TC} = V_o$ at 25°C after temperature cycle at +25°C to -40°C to +125°C and back to +25°C.

TYPICAL PERFORMANCE CHARACTERISTICS

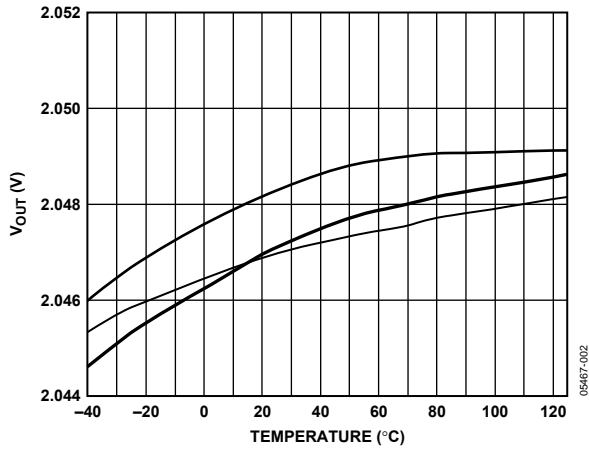

Figure 2. ADR360 Output Voltage vs. Temperature

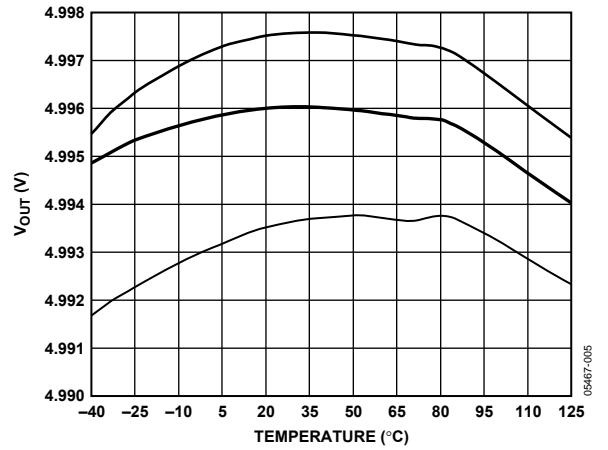

Figure 5. ADR365 Output Voltage vs. Temperature

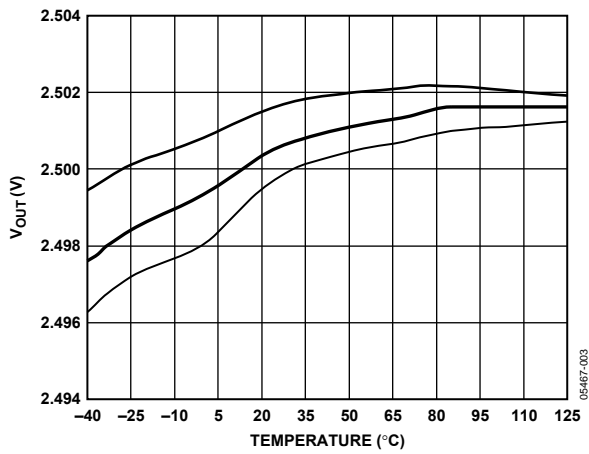

Figure 3. ADR361 Output Voltage vs. Temperature

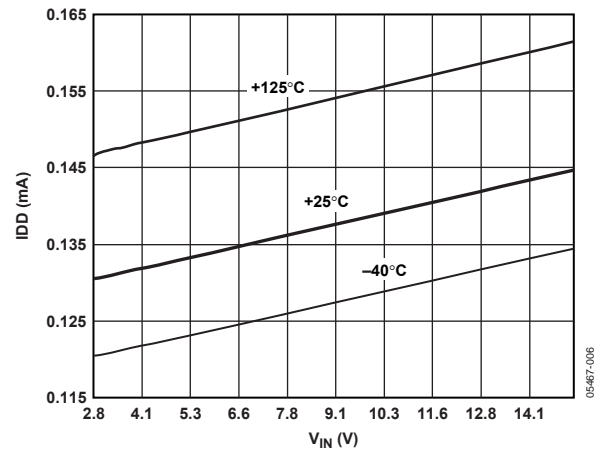

Figure 6. ADR361 Supply Current vs. Input Voltage

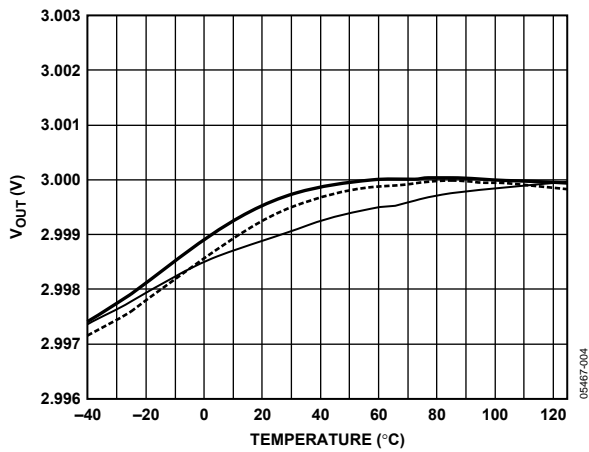

Figure 4. ADR363 Output Voltage vs. Temperature

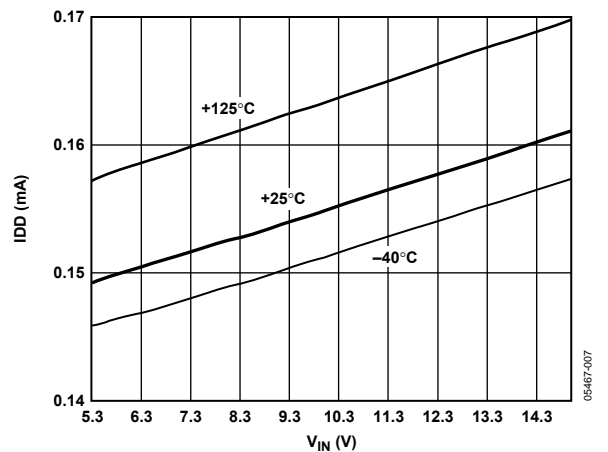

Figure 7. ADR365 Supply Current vs. Input Voltage

ADR360/ADR361/ADR363/ADR364/ADR365/ADR366

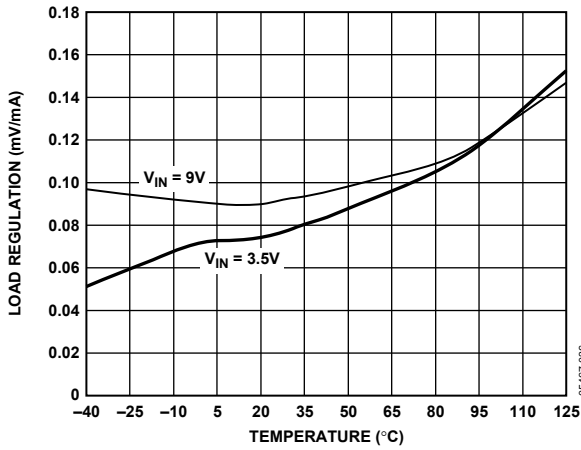

Figure 8. ADR361 Load Regulation vs. Temperature

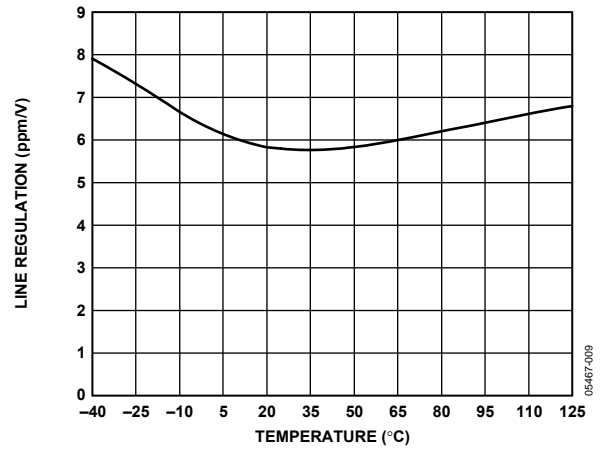

Figure 11. ADR361 Line Regulation vs. Temperature, $V_{IN} = 2.8\text{ V to }15\text{ V}$

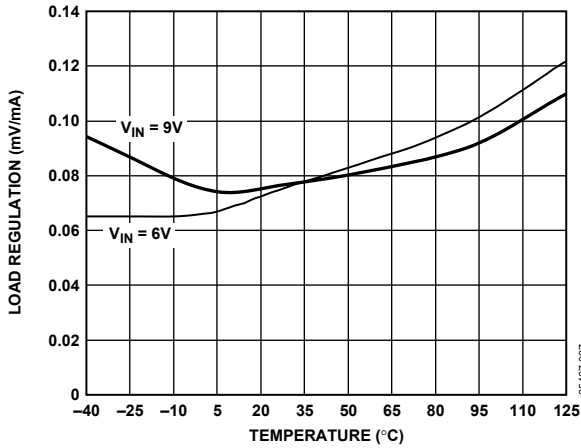

Figure 9. ADR365 Load Regulation vs. Temperature

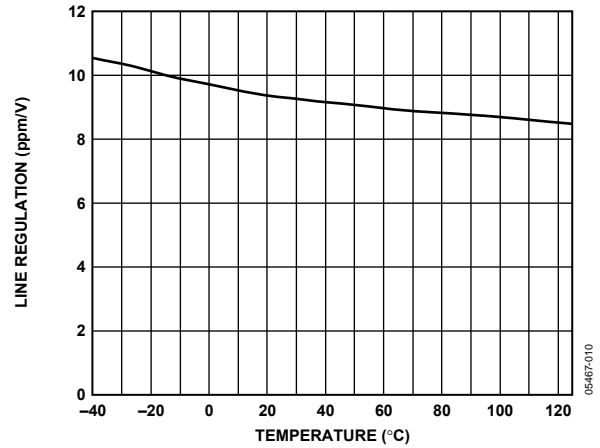

Figure 12. ADR365 Line Regulation vs. Temperature, $V_{IN} = 5.3\text{ V to }15\text{ V}$

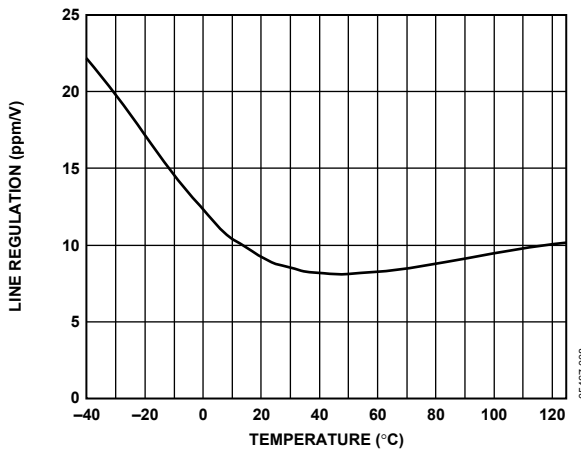

Figure 10. ADR360 Line Regulation vs. Temperature, $V_{IN} = 2.45\text{ V to }15\text{ V}$

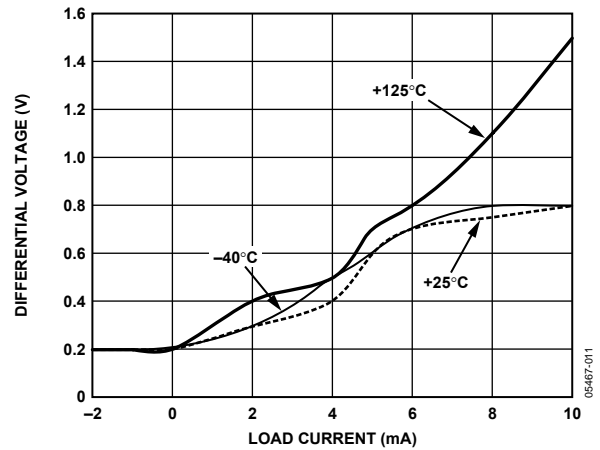

Figure 13. ADR361 Minimum Input Voltage vs. Load Current

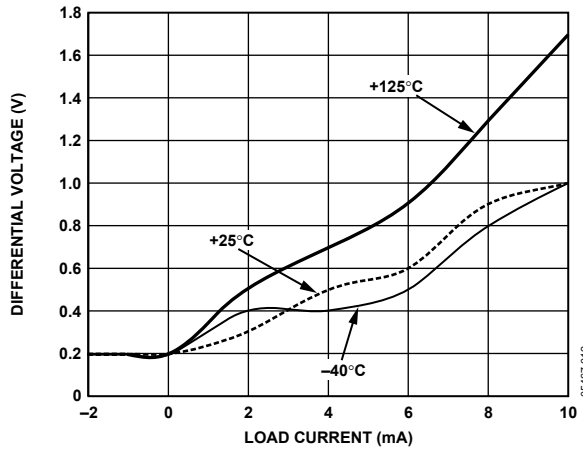

Figure 14. ADR365 Minimum Input Voltage vs. Load Current

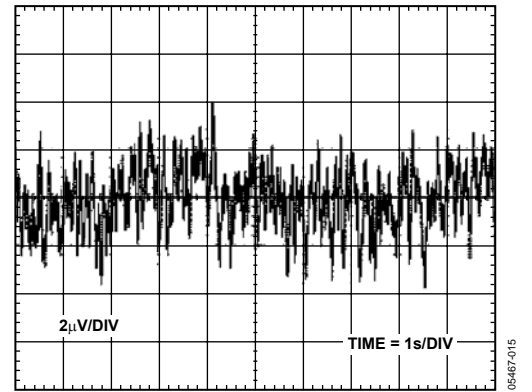

Figure 17. ADR363 0.1 Hz to 10 kHz Noise

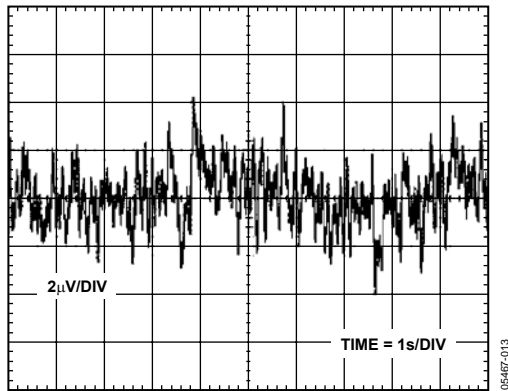

Figure 15. ADR361 0.1 Hz to 10 Hz Noise

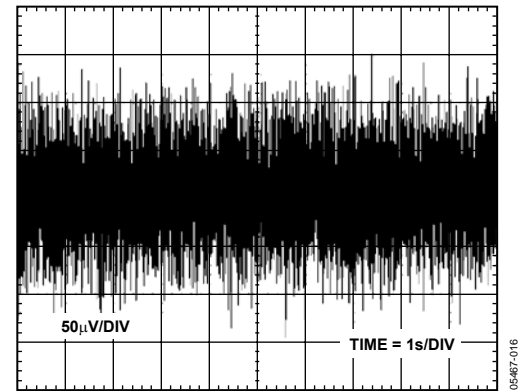

Figure 18. ADR363 10 Hz to 10 kHz Noise

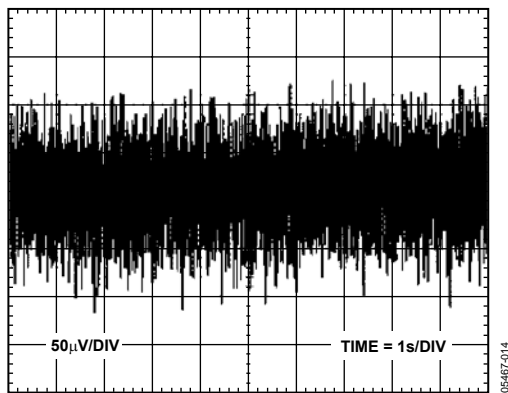

Figure 16. ADR361 10 Hz to 10 kHz Noise

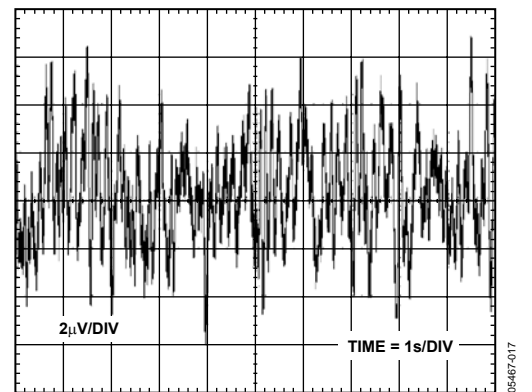

Figure 19. ADR365 0.1 Hz to 10 Hz Noise

ADR360/ADR361/ADR363/ADR364/ADR365/ADR366

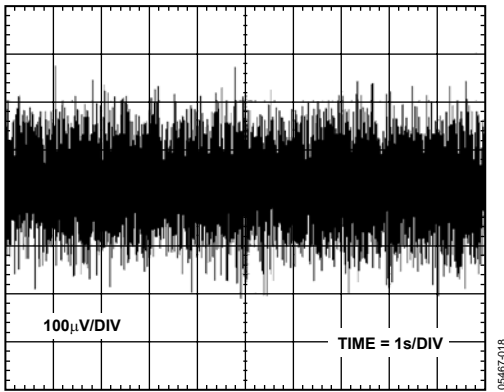

Figure 20. ADR365 10 Hz to 10 kHz Noise

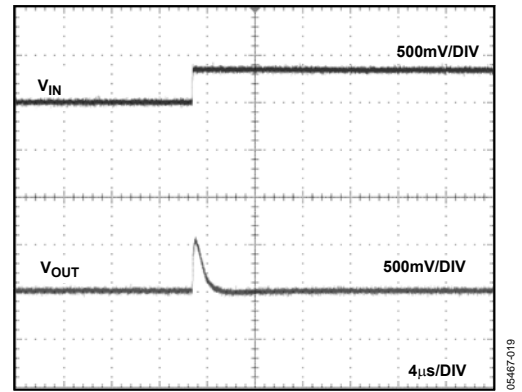

Figure 23. ADR361 Line Transient Response (Increasing), No Capacitors

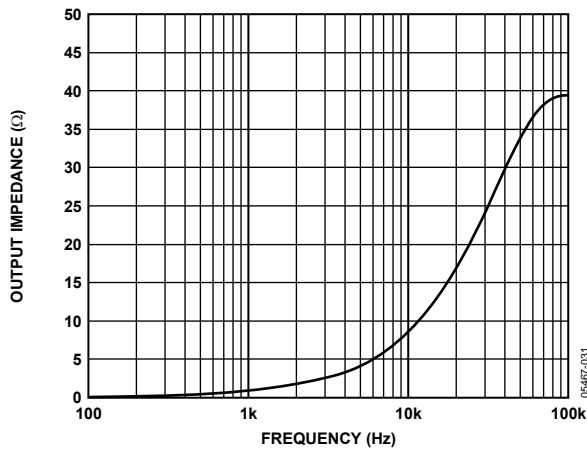

Figure 21. Output Impedance vs. Frequency

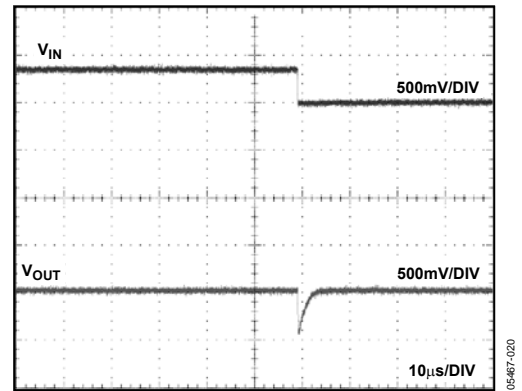

Figure 24. ADR361 Line Transient Response (Decreasing), No Capacitors

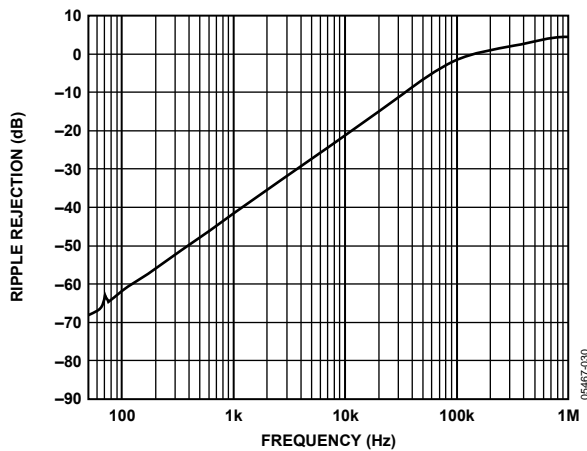

Figure 22. Ripple Rejection Ratio

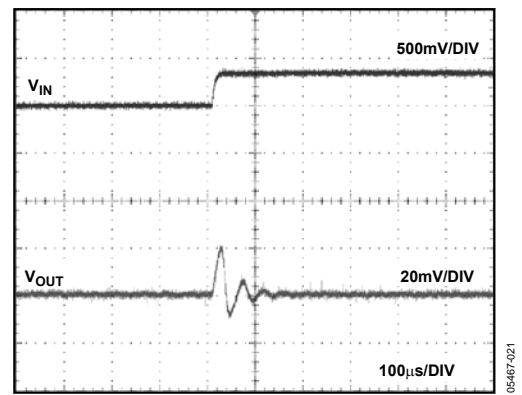

Figure 25. ADR361 Line Transient Response, 0.1 μ F Input Capacitor

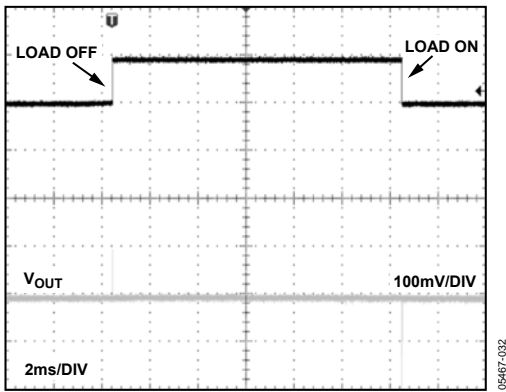

Figure 26. ADR361 Load Transient Response

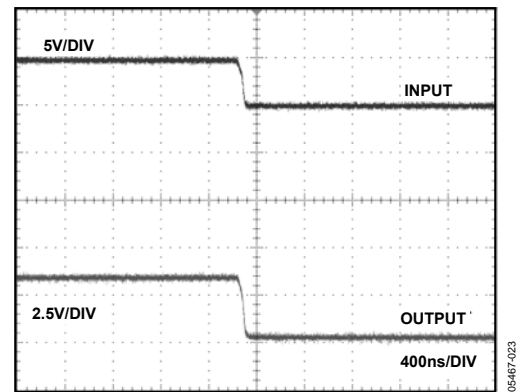

Figure 29. ADR361 Turn-Off Response at 5 V

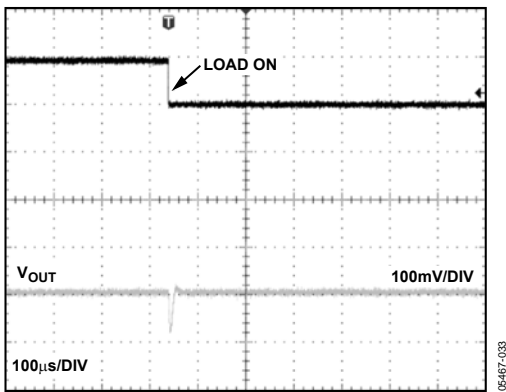

Figure 27. ADR361 Load Transient Response, 0.1 μ F Input, Output Capacitor

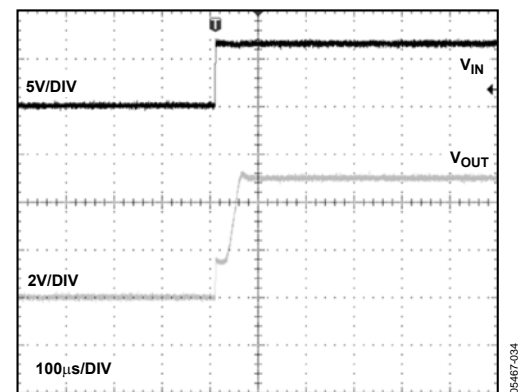

Figure 30. ADR361 Turn-On Response, 0.1 μ F Output Capacitor

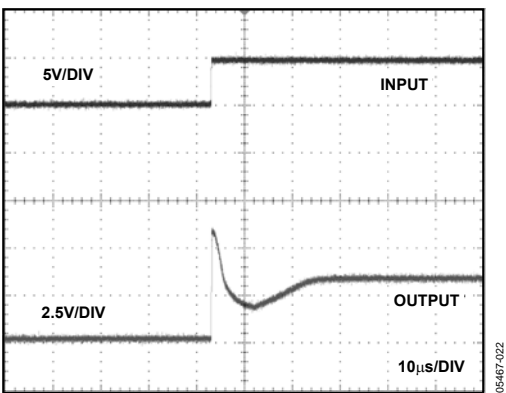

Figure 28. ADR361 Turn-On Response Time at 5 V

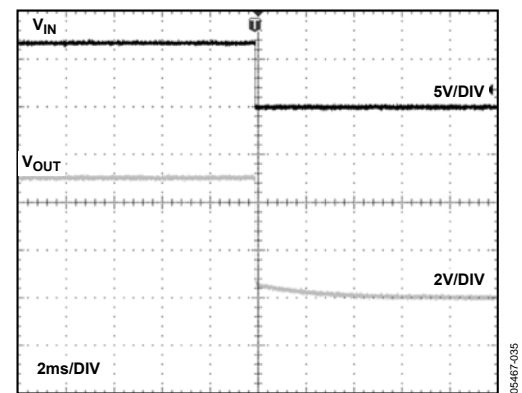

Figure 31. ADR361 Turn-Off Response, 0.1 μ F Output Capacitor

THEORY OF OPERATION

Band gap references are the high performance solution for low supply voltage and low power voltage reference applications, and the ADR36x family is no exception. The uniqueness of these products lies in their architecture. The ideal zero TC band gap voltage is referenced to the output not to ground (see Figure 32). Therefore, if noise exists on the ground line, it is greatly attenuated on V_{OUT} . The band gap cell consists of the PNP pair Q53 and Q52 running at unequal current densities. The difference in V_{BE} results in a voltage with a positive TC, which is amplified by a ratio of

$$2 \times \frac{R59}{R54}$$

This PTAT voltage, combined with the V_{BES} of Q53 and Q52, produces the stable band gap voltage.

Reduction in the band gap curvature is performed by the ratio of Resistor R44 and Resistor R59, one of which is linearly temperature dependent. Precision laser trimming and other patented circuit techniques are used to further enhance the drift performance.

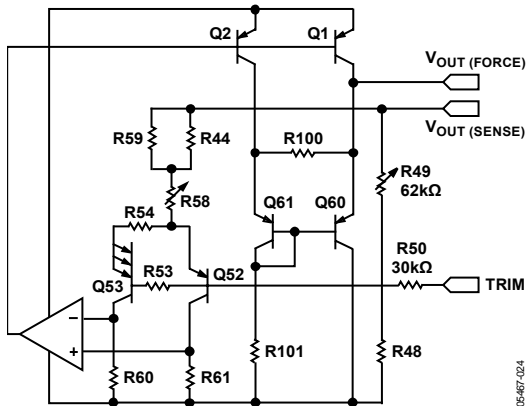

Figure 32. Simplified Schematic

DEVICE POWER DISSIPATION CONSIDERATIONS

The ADR36x family is capable of delivering load currents to 5 mA with an input voltage ranging from 2.348 V (ADR360 only) to 18 V. When this device is used in applications with large input voltages, care should be taken to avoid exceeding the specified maximum power dissipation or junction temperature because it could result in premature device failure. Use the following formula to calculate a device's maximum junction temperature or dissipation:

$$P_D = \frac{T_J - T_A}{\theta_{JA}}$$

In this equation, T_J and T_A are, respectively, the junction and ambient temperatures, P_D is the device power dissipation, and θ_{JA} is the device package thermal resistance.

INPUT CAPACITOR

Input capacitors are not required on the ADR36x. There is no limit for the value of the capacitor used on the input, but a 1 μF to 10 μF capacitor on the input improves transient response in applications where the supply suddenly changes. An additional 0.1 μF capacitor in parallel also helps reduce noise from the supply.

OUTPUT CAPACITOR

The ADR36x does not require output capacitors for stability under any load condition. An output capacitor, typically 0.1 μF , filters out any low level noise voltage and does not affect the operation of the part. On the other hand, the load transient response can improve with an additional 1 μF to 10 μF output capacitor in parallel. A capacitor here acts as a source of stored energy for a sudden increase in load current. The only parameter that degrades by adding an output capacitor is the turn-on time. The degradation depends on the size of the capacitor chosen.

APPLICATIONS

BASIC VOLTAGE REFERENCE CONNECTION

The circuit in Figure 33 illustrates the basic configuration for the ADR36x family. Decoupling capacitors are not required for circuit stability. The ADR36x family is capable of driving capacitive loads from 0 μ F to 10 μ F. However, a 0.1 μ F ceramic output capacitor is recommended to absorb and deliver the charge as is required by a dynamic load.

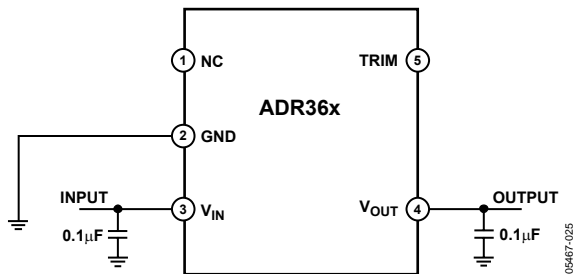

Figure 33. Basic Configuration for the ADR36x Family

Stacking Reference ICs for Arbitrary Outputs

Some applications can require two reference voltage sources, which are a combined sum of standard outputs. Figure 34 shows how this stacked output reference can be implemented.

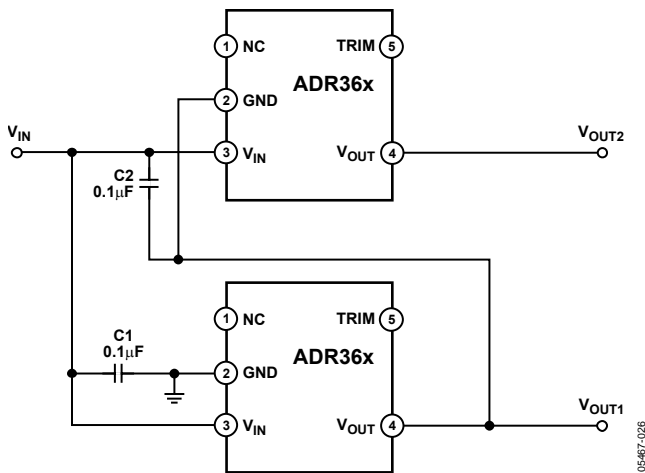

Figure 34. Stacking Voltage References with the ADR36x

Two reference ICs are used and fed from an unregulated input, V_{IN} . The outputs of the individual ICs are connected in series, which provides two output voltages, V_{OUT1} and V_{OUT2} . V_{OUT1} is the terminal voltage of U1, while V_{OUT2} is the sum of this voltage and the terminal voltage of U2. U1 and U2 are chosen for the two voltages that supply the required outputs (see Table 10). For example, if both U1 and U2 are ADR361s, V_{OUT1} is 2.5 V and V_{OUT2} is 5.0 V.

Table 10. Output

U1/U2	V_{OUT1}	V_{OUT2}
ADR361/ADR365	2.5	7.5
ADR361/ADR361	2.5	5.0
ADR365/ADR361	5	7.5

A Negative Precision Reference Without Precision Resistors

A negative reference is easily generated by adding an op amp, A1 and is configured in Figure 35. V_{OUTF} and V_{OUTS} are at virtual ground and, therefore, the negative reference can be taken directly from the output of the op amp. The op amp must be dual-supply, low offset, and rail-to-rail if the negative supply voltage is close to the reference output.

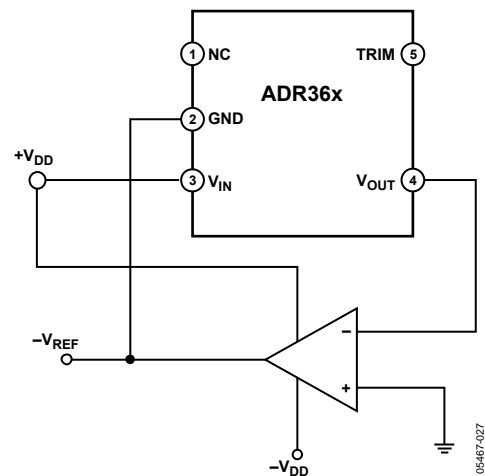

Figure 35. Negative Reference

ADR360/ADR361/ADR363/ADR364/ADR365/ADR366

General-Purpose Current Source

Many times in low power applications, the need arises for a precision current source that can operate on low supply voltages. The ADR36x can be configured as a precision current source (see Figure 36). The circuit configuration illustrated is a floating current source with a grounded load. The reference's output voltage is bootstrapped across R_{SET} , which sets the output current into the load. With this configuration, circuit precision is maintained for load currents ranging from the reference's supply current, typically 150 μA , to approximately 5 mA.

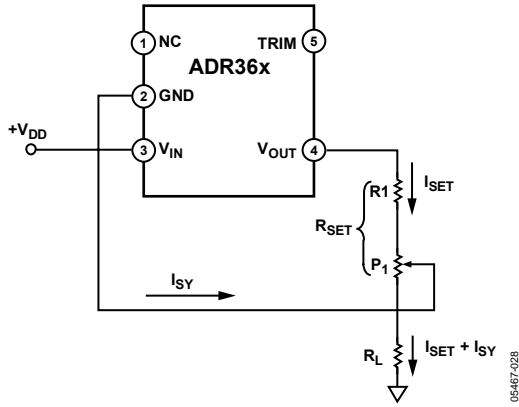

Figure 36. Precision Current Source

Trim Terminal

The ADR36x trim terminal can be used to adjust the output voltage over a nominal voltage. This feature allows a system designer to trim system errors by setting the reference to a voltage other than the standard voltage option. Resistor R1 is used for fine adjustment and can be omitted if desired. The resistor values should be carefully chosen to ensure that the maximum current drive of the part is not exceeded.

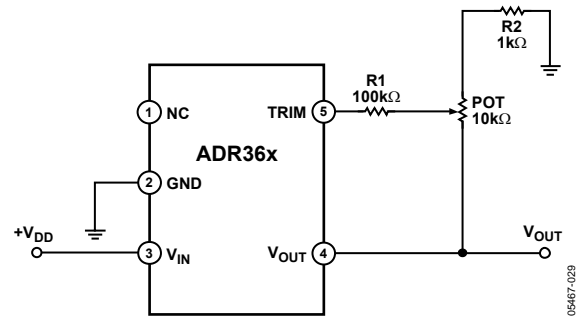
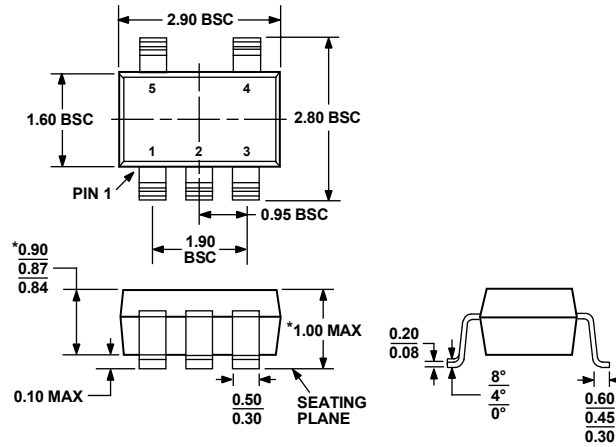

Figure 37. ADR36x Trim Configuration

OUTLINE DIMENSIONS



*COMPLIANT TO JEDEC STANDARDS MO-193-AB WITH THE EXCEPTION OF PACKAGE HEIGHT AND THICKNESS.

Figure 38. 5-Lead Thin Small Outline Transistor Package [TSOT] (UJ-5)

Dimensions shown in millimeters

ORDERING GUIDE

Models ¹	Output Voltage (V _O)	Initial Accuracy		Temperature Coefficient (ppm/°C)	Package Description	Package Option	Temperature Range	Branding
		(mV)	(%)					
ADR360AUJZ-REEL ²	2.048	6	0.29	25	5-Lead TSOT	UJ-5	-40°C to +125°C	R0C
ADR360BUJZ-REEL ²	2.048	3	0.15	9	5-Lead TSOT	UJ-5	-40°C to +125°C	R0D
ADR361AUJZ-REEL ²	2.5	6	0.24	25	5-Lead TSOT	UJ-5	-40°C to +125°C	R0E
ADR361BUJZ-REEL ²	2.5	3	0.12	9	5-Lead TSOT	UJ-5	-40°C to +125°C	R0F
ADR363AUJZ-REEL ²	3.0	6	0.2	25	5-Lead TSOT	UJ-5	-40°C to +125°C	R0G
ADR363BUJZ-REEL ²	3.0	3	0.1	9	5-Lead TSOT	UJ-5	-40°C to +125°C	R0H
ADR364AUJZ-REEL ²	4.096	8	0.2	25	5-Lead TSOT	UJ-5	-40°C to +125°C	R0J
ADR364BUJZ-REEL ²	4.096	4	0.1	9	5-Lead TSOT	UJ-5	-40°C to +125°C	R0K
ADR365AUJZ-REEL ²	5.0	8	0.16	25	5-Lead TSOT	UJ-5	-40°C to +125°C	R0L
ADR365BUJZ-REEL ²	5.0	4	0.08	9	5-Lead TSOT	UJ-5	-40°C to +125°C	R0M
ADR366AUJZ-REEL ²	3.3	8	0.25	25	5-Lead TSOT	UJ-5	-40°C to +125°C	R08
ADR366BUJZ-REEL ²	3.3	4	0.125	9	5-Lead TSOT	UJ-5	-40°C to +125°C	R09

¹ 3,000 pieces per reel.

² Z = Pb-free part.

ADR360/ADR361/ADR363/ADR364/ADR365/ADR366

NOTES