

Product Features

- DC – 6 GHz
- +15.5 dBm P1dB at 1 GHz
- +29 dBm OIP3 at 1 GHz
- 20 dB Gain at 1 GHz
- 3.8 dB Noise Figure
- Available in lead-free/green SOT-86, SOT-363, & SOT-89 package styles
- Internally matched to 50 Ω

Applications

- Mobile Infrastructure
- CATV / FTTH
- W-LAN / ISM
- RFID
- WiMAX / WiBro

Product Description

The ECG002 is a general-purpose buffer amplifier that offers high dynamic range in a low-cost surface-mount package. At 1000 MHz, the ECG002 typically provides 20 dB of gain, +29 dBm Output IP3, and +15.5 dBm P1dB.

The ECG002 consists of Darlington pair amplifiers using the high reliability InGaP/GaAs HBT process technology and only requires DC-blocking capacitors, a bias resistor, and an inductive RF choke for operation. The device is ideal for wireless applications and is available in low-cost, surface-mountable plastic lead-free/green/RoHS-compliant SOT-363, SOT-86 and SOT-89 packages. All devices are 100% RF and DC tested.

The broadband MMIC amplifier can be directly applied to various current and next generation wireless technologies such as GPRS, GSM, CDMA, and W-CDMA. In addition, the ECG002 will work for other various applications within the DC to 6 GHz frequency range such as CATV and mobile wireless.

Functional Diagram

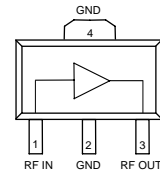

ECG002B-G

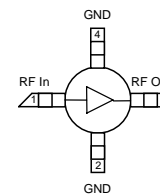

ECG002C-G

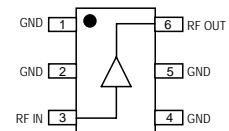

ECG002F-G

Specifications ⁽¹⁾

Parameter	Units	Min	Typ	Max
Operational Bandwidth	MHz	DC		6000
Test Frequency	MHz		1000	
Gain	dB		20	
Output P1dB	dBm		+15.5	
Output IP3 ⁽²⁾	dBm		+29	
Test Frequency	MHz		2000	
Gain	dB	17	19	
Large-signal Gain ⁽³⁾	dB	16	18	
Output P1dB	dBm	+13	+15	
Output IP3 ⁽²⁾	dBm		+29	
Noise Figure	dB		3.8	
Device Voltage	V	3.5	3.9	4.3
Device Current	mA		45	

1. Test conditions unless otherwise noted: 25 °C, Supply Voltage = +5 V, R_{bias} = 24 Ω, 50 Ω System.
2. 3OIP measured with two tones at an output power of +2 dBm/tone separated by 1 MHz. The suppression on the largest IM3 product is used to calculate the 3OIP using a 2:1 rule.
3. Large-signal gain is tested with an input power level of -3 dBm.

Typical Performance ⁽¹⁾

Parameter	Units	Typical			
Frequency	MHz	500	900	1900	2140
S21	dB	20.6	20	19.5	18.7
S11	dB	-17	-17	-15	-15
S22	dB	-18	-18	-21	-21
Output P1dB	dBm	+15.8	+15.5	+15	+14.9
Output IP3	dBm	+28	+29	+29	+29
Noise Figure	dB	3.8	3.7	3.8	3.8

Absolute Maximum Rating

Parameter	Rating
Operating Case Temperature	-40 to +85 °C
Storage Temperature	-55 to +150 °C
Device Current	150 mA
RF Input Power (continuous)	+12 dBm
Junction Temperature	+250 °C

Operation of this device above any of these parameters may cause permanent damage.

Ordering Information

Part No.	Description
ECG002B-G	InGaP HBT Gain Block (lead-free/green/RoHS-compliant SOT-89 package)
ECG002C-G	InGaP HBT Gain Block (lead-free/green/RoHS-compliant SOT-86 package)
ECG002F-G	InGaP HBT Gain Block (lead-free/green/RoHS-compliant SOT-363 package)
ECG002B-PCB	700 – 2400 MHz Fully Assembled Eval. Board
ECG002C-PCB	700 – 2400 MHz Fully Assembled Eval. Board
ECG002F-PCB	700 – 2400 MHz Fully Assembled Eval. Board

Specifications and information are subject to change without notice



Typical Device RF Performance

Supply Bias = +5 V, $R_{bias} = 24 \Omega$, $I_{cc} = 45 \text{ mA}$

Frequency	MHz	100	500	900	1900	2140	2400	3500	5800
S21	dB	21	20.6	20	19.5	18.7	18.2	16.4	13.3
S11	dB	-18	-17	-17	-15	-15	-15	-16	-19
S22	dB	-17	-17	-18	-20	-21	-22	-35	-16
Output P1dB	dBm	+15.4	+15.6	+15.5	+15	+15	+15	+14.5	+11
Output IP3	dBm	+28	+28	+29	+29	+29	+29		
Noise Figure	dB	3.9	3.8	3.8	3.8	3.8	3.9		

1. Test conditions: $T = 25^\circ \text{C}$, Supply Voltage = +5 V, Device Voltage = +3.9 V, $R_{bias} = 24 \Omega$, $I_{cc} = 45 \text{ mA}$ typical, 50Ω System.
2. 3OIP measured with two tones at an output power of -1 dBm/tone separated by 1 MHz. The suppression on the largest IM3 product is used to calculate the 3OIP using a 2:1 rule.
3. Data is shown as device performance only. Actual implementation for the desired frequency band will be determined by external components shown in the application circuit.

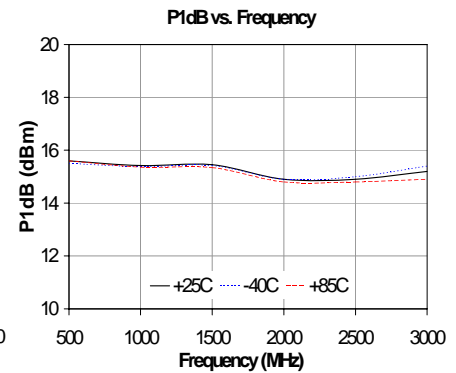
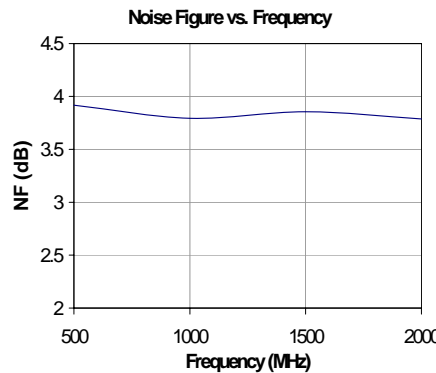
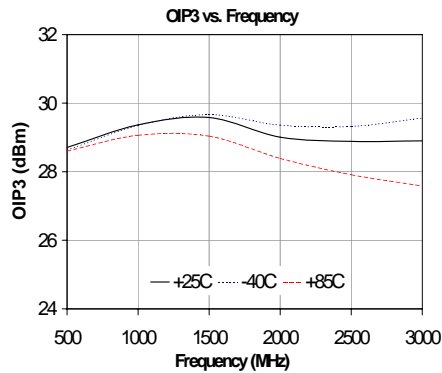
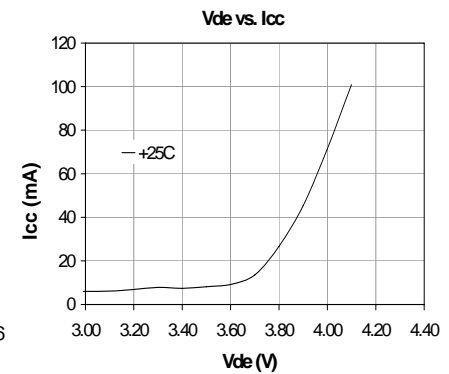
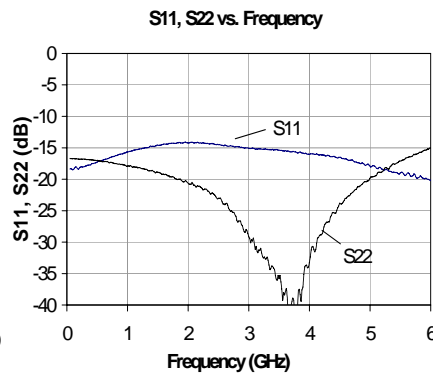
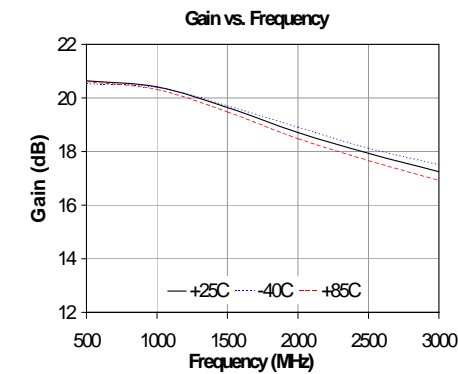

Recommended Application Circuit

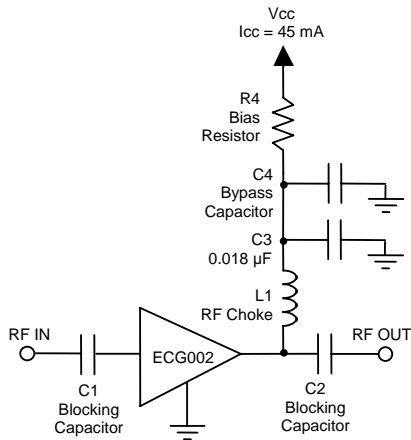

ECG002C-PCB

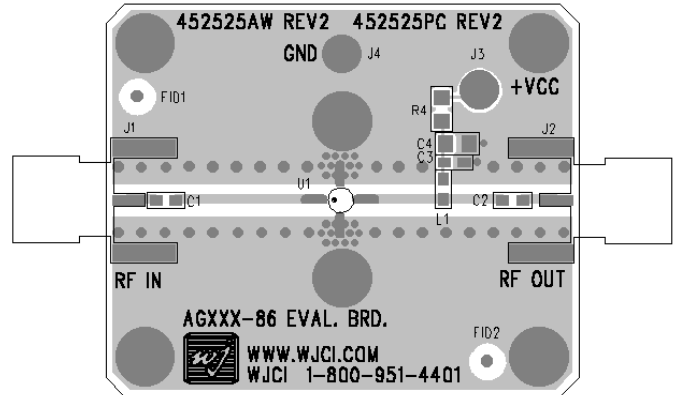

ECG002B-PCB

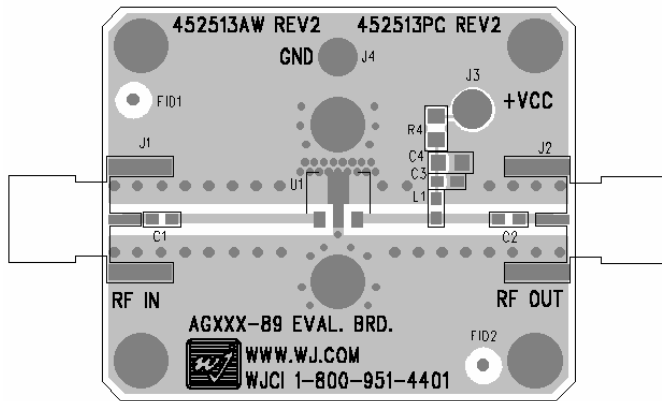

ECG002F-PCB

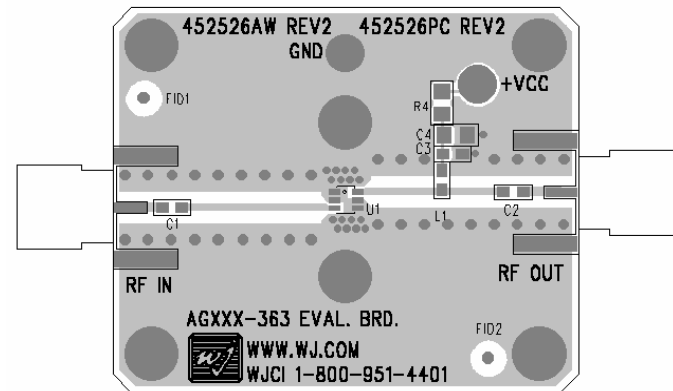

Recommended Component Values

Reference Designator	Frequency (MHz)						
	50	500	900	1900	2200	2500	3500
L1	820 nH	220 nH	68 nH	27 nH	22 nH	18 nH	15 nH
C1, C2, C4	.018 µF	1000 pF	100 pF	68 pF	68 pF	56 pF	39 pF

- The proper values for the components are dependent upon the intended frequency of operation.
- The following values are contained on the evaluation board to achieve optimal broadband performance:

Ref. Desig.	Value / Type	Size
L1	39 nH wirewound inductor	0603
C1, C2	56 pF chip capacitor	0603
C3	0.018 µF chip capacitor	0603
C4	Do Not Place	
R4	24Ω 1% tolerance	0805

Recommended Bias Resistor Values

Supply Voltage	R1 value	Size
5 V	24.4 ohms	0805
6 V	46.7 ohms	0805
8 V	91 ohms	1210
9 V	113 ohms	1210
10 V	136 ohms	2010
12 V	180 ohms	2010

The proper value for R1 is dependent upon the supply voltage and allows for bias stability over temperature. WJ recommends a minimum supply bias of +5 V. A 1% tolerance resistor is recommended.

ECG002B-G Mechanical Information

This package is lead-free/Green/RoHS-compliant. The plating material on the leads is NiPdAu. It is compatible with both lead-free (maximum 260 °C reflow temperature) and leaded (maximum 245 °C reflow temperature) soldering processes.

Outline Drawing

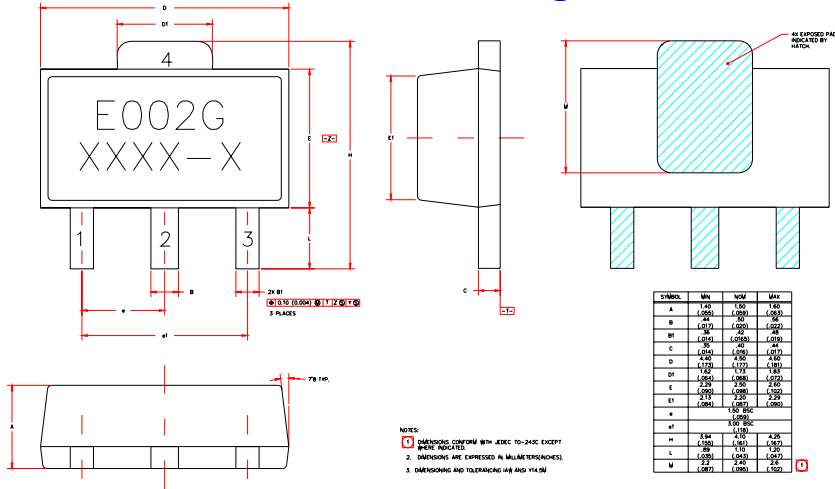

Product Marking

The component will be marked with an “E002G” designator with an alphanumeric lot code on the top surface of the package. The obsolete tin-lead package is marked with an “E002” designator followed by an alphanumeric lot code; it may also have been marked with a “C” designator followed by a 3-digit numeric lot code.

Tape and reel specifications for this part are located on the website in the “Application Notes” section.

MSL / ESD Rating



Caution! ESD sensitive device.

ESD Rating: Class 1A
Value: Passes between 250 and 500V
Test: Human Body Model (HBM)
Standard: JEDEC Standard JESD22-A114

MSL Rating: Level 3 at +260 °C convection reflow
Standard: JEDEC Standard J-STD-020

Land Pattern

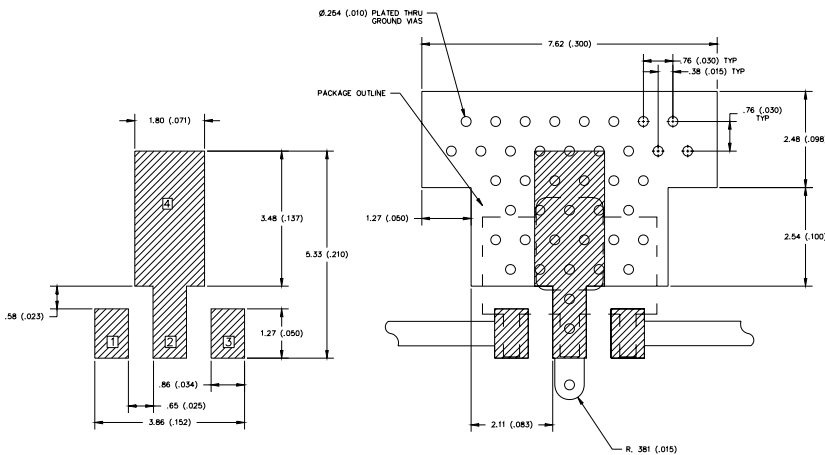

Mounting Config. Notes

- Ground / thermal vias are critical for the proper performance of this device. Vias should use a .35mm (#80 / .0135”) diameter drill and have a final plated thru diameter of .25 mm (.010”).
- Add as much copper as possible to inner and outer layers near the part to ensure optimal thermal performance.
- Mounting screws can be added near the part to fasten the board to a heatsink. Ensure that the ground / thermal via region contacts the heatsink.
- Do not put solder mask on the backside of the PC board in the region where the board contacts the heatsink.
- RF trace width depends upon the PC board material and construction.
- Use 1 oz. Copper minimum.
- All dimensions are in millimeters (inches). Angles are in degrees.



ECG002C-G Mechanical Information

This package is lead-free/Green/RoHS-compliant. The plating material on the pins is annealed matte tin over copper. It is compatible with both lead-free (maximum 260 °C reflow temperature) and leaded (maximum 245 °C reflow temperature) soldering processes.

Outline Drawing

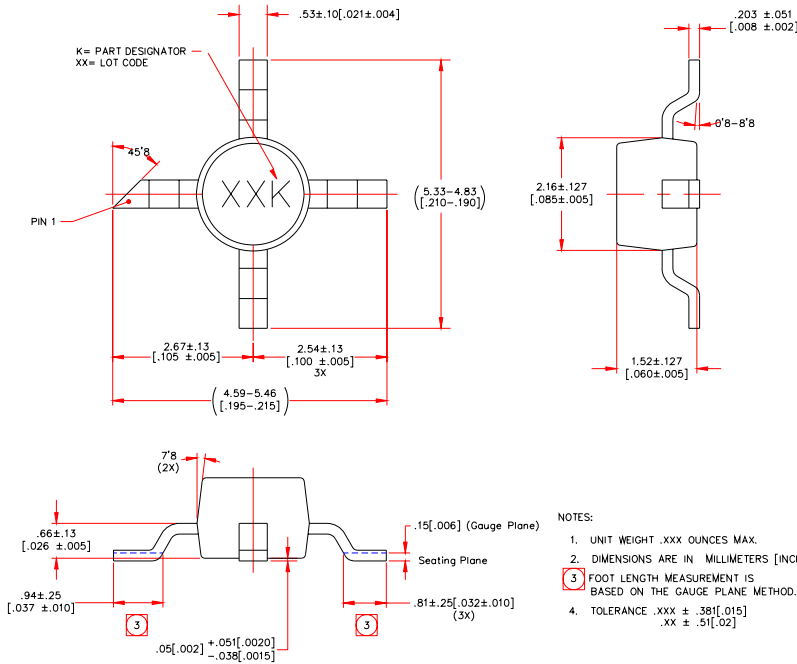

Land Pattern

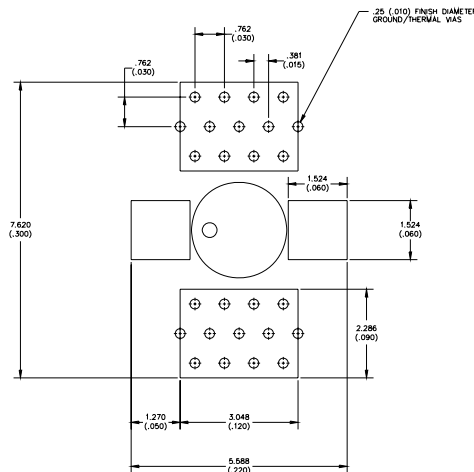

Product Marking

The component will be marked with a two-digit numeric lot code (shown as "XX") followed with a "K" designator on the top surface of the package. The obsolete tin-lead package is marked with a two-digit numeric lot code followed with a "J" designator; it may also have been marked with a "J" designator followed by a two-digit lot code.

Tape and reel specifications for this part are located on the website in the "Application Notes" section.

MSL / ESD Rating



Caution! ESD sensitive device.

ESD Rating: Class 1A
Value: Passes between 250 and 500V
Test: Human Body Model (HBM)
Standard: JEDEC Standard JESD22-A114

MSL Rating: Level 3 at +260 °C convection reflow
Standard: JEDEC Standard J-STD-020

Mounting Config. Notes

1. Ground / thermal vias are critical for the proper performance of this device. Vias should use a .35mm (#80 / .0135") diameter drill and have a final plated thru diameter of .25 mm (.010").
2. Add as much copper as possible to inner and outer layers near the part to ensure optimal thermal performance.
3. Mounting screws can be added near the part to fasten the board to a heatsink. Ensure that the ground / thermal via region contacts the heatsink.
4. Do not put solder mask on the backside of the PC board in the region where the board contacts the heatsink.
5. RF trace width depends upon the PC board material and construction.
6. Use 1 oz. Copper minimum.
7. All dimensions are in millimeters (inches). Angles are in degrees.

ECG002F-G Mechanical Information

This package is lead-free/Green/RoHS-compliant. The plating material on the leads is annealed matte tin over copper. It is compatible with both lead-free (maximum 260 °C reflow temperature) and leaded (maximum 245 °C reflow temperature) soldering processes.

Outline Drawing

SYMBOL	MIN	MAX
A	0.80 (.031)	1.20 (.047)
A1	0.05 (.002)	.15 (.006)
A2	0.80 (.031)	.05 (.004)
D	1.80 (.071)	2.20 (.087)
E	1.80 (.071)	2.40 (.094)
E1	0.10 (.004)	1.30 (.051)
L	0.10 (.004)	0.12 (.012)
L1	0.15 (.006)	0.18 (.007)
L2	0.09 (.004)	0.18 (.007)
b	0.15 (.006)	0.40 (.016)
c	.09 (.004)	.18 (.007)
e	.65 BASIC (.026)	
e1	1.30 BASIC (.051)	

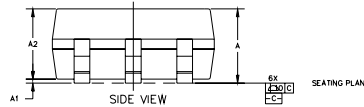
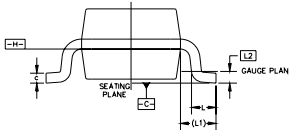
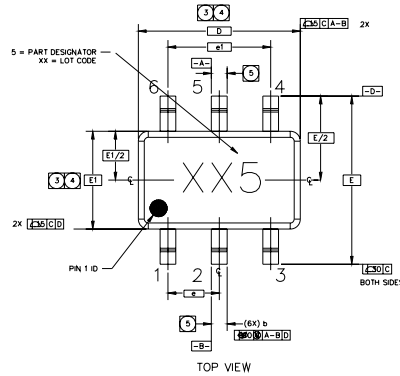

NOTES:

- DIMENSIONS AND TOLERANCING PER ASME Y14.5M-1194. PACKAGE CONFORMS TO JEDEC MO-203, ISSUE B.
- DIMENSIONS ARE IN MILLIMETERS (INCHES).
- DIMENSION D DOES NOT INCLUDE MOLD FLASH, PROTRUSIONS OR GATE BURRS. MOLD FLASH, PROTRUSIONS OR GATE BURRS SHALL NOT EXCEED 0.15 mm PER END. DIMENSION E1 DOES NOT INCLUDE INTERLEAD FLASH OR PROTRUSION. INTERLEAD FLASH OR PROTRUSION SHALL NOT EXCEED 0.15 mm PER SIDE. D AND E1 DIMENSIONS ARE DETERMINED AT DATUM H.
- THE PACKAGE TOP MAY BE SMALLER THAN THE PACKAGE BOTTOM. DIMENSIONS D AND E1 ARE DETERMINED AT THE OUTERMOST EXTREMES OF THE PLASTIC BODY EXCLUSIVE OF MOLD FLASH, GATE BURRS, GATE BURRS AND INTERLEAD FLASH, BUT INCLUDING ANY MISMATCH BETWEEN THE TOP AND THE BOTTOM OF THE PLASTIC BODY. D AND E1 DIMENSIONS ARE DETERMINED AT DATUM H.

3 DATUM A & B TO BE DETERMINED AT DATUM H.

6 DIMENSION 'b' DOES NOT INCLUDE DAMBAR PROTRUSION. ALLOWABLE DAMBAR PROTRUSION SHALL BE 0.08 mm TOTAL IN EXCESS OF THE 'b' DIMENSION AT MAXIMUM MATERIAL CONDITION. THE DAMBAR IS NOT LOCATED ON THE LOWER RADII OF THE FOOT. MINIMUM SPACE BETWEEN PROTRUSION AND AN ADJACENT LEAD SHALL NOT BE LESS THAN 0.07 mm.

Product Marking

The component will be marked with a two-digit numeric lot code (shown as "XX") followed with a "5" designator on the top surface of the package. The obsolete tin-lead package is marked with a two-digit numeric lot code followed with a "1" designator; it may also have been marked with a "10" designator followed by a letter lot code.

Tape and reel specifications for this part are located on the website in the "Application Notes" section.

MSL / ESD Rating



Caution! ESD sensitive device.

ESD Rating: Class 1A

Value: Passes between 250 and 500V

Test: Human Body Model (HBM)

Standard: JEDEC Standard JESD22-A114

MSL Rating: Level 3 at +260 °C convection reflow

Standard: JEDEC Standard J-STD-020

Land Pattern

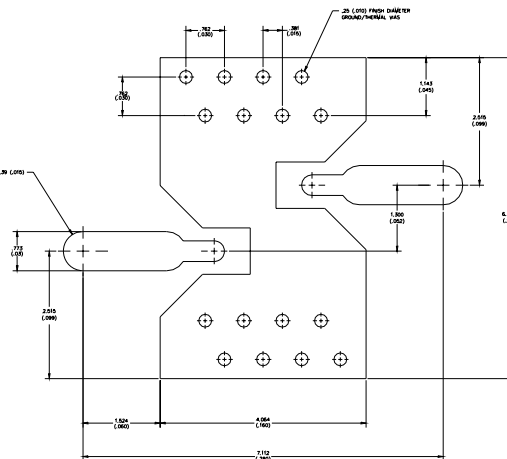

Mounting Config. Notes

- Ground / thermal vias are critical for the proper performance of this device. Vias should use a .35mm (#80 / .0135") diameter drill and have a final plated thru diameter of .25 mm (.010").
- Add as much copper as possible to inner and outer layers near the part to ensure optimal thermal performance.
- Mounting screws can be added near the part to fasten the board to a heatsink. Ensure that the ground / thermal via region contacts the heatsink.
- Do not put solder mask on the backside of the PC board in the region where the board contacts the heatsink.
- RF trace width depends upon the PC board material and construction.
- Use 1 oz. Copper minimum.
- All dimensions are in millimeters (inches). Angles are in degrees.

Typical Device S-Parameters – ECG002B-G

S-Parameters ($V_{\text{device}} = +3.9 \text{ V}$, $I_{\text{CC}} = 45 \text{ mA}$, $T = 25 \text{ }^\circ\text{C}$, calibrated to device leads)

Freq (MHz)	S11 (dB)	S11 (ang)	S21 (dB)	S21 (ang)	S12 (dB)	S12 (ang)	S22 (dB)	S22 (ang)
50	-17.15	0.33	21.23	177.70	-23.14	-0.19	-15.62	-1.52
500	-16.04	0.38	20.84	156.45	-23.06	-1.64	-15.69	-20.22
1000	-14.81	-8.39	20.03	135.90	-22.83	-2.70	-15.79	-38.56
1500	-13.59	-21.57	19.11	118.25	-22.47	-4.36	-15.62	-58.17
2000	-13.14	-38.98	18.50	103.23	-21.81	-7.40	-15.49	-81.71
2500	-13.40	-54.87	18.01	87.48	-21.28	-11.83	-15.86	-107.96
3000	-13.96	-68.82	17.49	71.83	-20.73	-17.30	-16.64	-139.16
3500	-15.15	-79.85	16.95	56.22	-20.34	-22.68	-17.60	-171.00
4000	-17.07	-85.86	16.36	41.14	-19.95	-28.74	-17.11	151.84
4500	-19.43	-86.07	15.78	26.53	-19.57	-34.89	-15.61	119.05
5000	-24.29	-76.56	15.19	12.27	-19.34	-42.28	-13.30	94.72
5500	-26.31	-15.89	14.64	-1.79	-19.04	-49.74	-10.79	76.65
6000	-21.31	17.01	14.08	-16.11	-18.87	-57.89	-8.79	61.13

Typical Device S-Parameters – ECG002C-G

S-Parameters ($V_{\text{device}} = +3.9 \text{ V}$, $I_{\text{CC}} = 45 \text{ mA}$, $T = 25 \text{ }^\circ\text{C}$, calibrated to device leads)

Freq (MHz)	S11 (dB)	S11 (ang)	S21 (dB)	S21 (ang)	S12 (dB)	S12 (ang)	S22 (dB)	S22 (ang)
50	-37.42	134.67	22.11	177.84	-23.75	0.04	-36.75	-5.01
500	-22.95	51.84	21.83	159.38	-23.57	1.76	-24.35	-54.15
1000	-20.13	57.46	21.21	140.39	-23.62	1.39	-22.33	-124.91
1500	-19.79	55.23	20.35	123.69	-23.56	2.36	-17.57	-159.03
2000	-19.82	31.10	19.41	108.29	-23.07	2.45	-15.79	-172.54
2500	-16.54	-1.82	18.63	95.93	-23.05	1.89	-17.22	-173.92
3000	-15.67	-7.79	17.69	83.59	-22.20	3.83	-15.86	168.33
3500	-15.94	-8.76	16.88	71.85	-21.97	1.75	-14.21	145.59
4000	-17.24	-5.83	15.94	60.22	-21.37	-2.61	-12.04	128.60
4500	-19.29	-2.21	15.15	49.25	-20.84	-5.08	-10.26	120.09
5000	-23.85	-16.76	14.45	39.80	-20.62	-6.52	-9.57	116.71
5500	-28.00	-81.95	13.89	30.92	-19.77	-7.93	-9.86	118.09
6000	-22.34	-134.50	13.34	21.26	-19.58	-13.03	-10.90	119.18

Typical Device S-Parameters – ECG002F-G

S-Parameters ($V_{\text{device}} = +3.9 \text{ V}$, $I_{\text{CC}} = 45 \text{ mA}$, $T = 25 \text{ }^\circ\text{C}$, calibrated to device leads)

Freq (MHz)	S11 (dB)	S11 (ang)	S21 (dB)	S21 (ang)	S12 (dB)	S12 (ang)	S22 (dB)	S22 (ang)
50	-35.58	153.00	22.09	177.80	-23.58	1.09	-41.45	-0.41
500	-25.34	51.37	21.86	159.87	-23.60	0.02	-25.01	-55.13
1000	-22.93	66.15	21.29	141.06	-23.30	2.10	-22.43	-134.17
1500	-21.74	76.98	20.47	124.48	-23.66	2.66	-16.71	-168.31
2000	-22.60	53.21	19.58	108.93	-23.31	1.22	-14.43	179.01
2500	-19.67	6.41	18.83	96.29	-22.86	-0.98	-15.12	176.50
3000	-18.00	3.61	17.93	83.64	-22.60	1.33	-13.82	164.54
3500	-17.76	4.44	17.12	71.47	-22.02	-1.64	-12.58	145.98
4000	-18.59	7.79	16.21	59.28	-21.64	-1.94	-10.90	130.27
4500	-20.60	19.66	15.42	48.02	-21.30	-4.58	-9.39	117.60
5000	-27.53	28.83	14.71	38.32	-20.52	-9.65	-8.57	112.39
5500	-37.18	-144.72	14.08	29.10	-20.32	-9.39	-8.88	113.57
6000	-24.38	-146.24	13.53	19.53	-19.40	-14.12	-9.58	114.73

Device S-parameters are available for download off of the website at: <http://www.wj.com>