

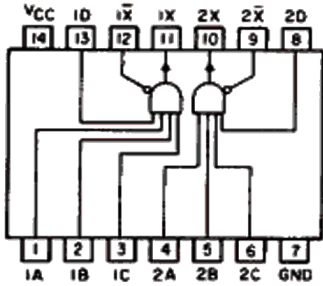

INTEGRATED CIRCUIT PINOUTS CONT.

SK7460

Dual 4-Input Expanders
Outline No. IC-048



SK7473 SK74LS73

Dual J-K Flip-Flop with Clear
Outline No. IC-048

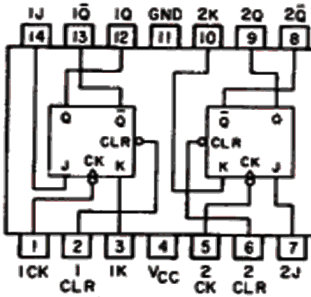

SK7476 SK74LS76A

Dual J-K Flip-Flop, Preset & Clear
Outline No. IC-048

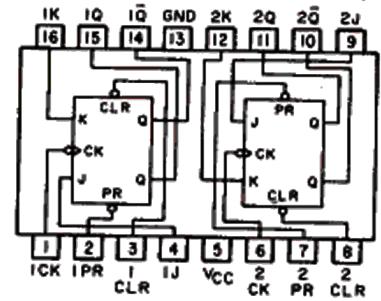

SK7470

AND-Gate J-K Pos-Edge-Trig Flip-Flop, Preset & Clear
Outline No. IC-048

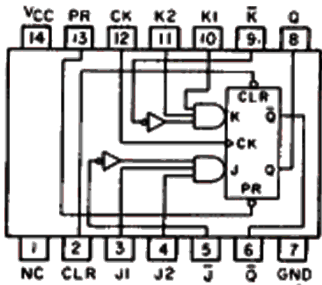

SK7474 SK74LS74A SK74S74

Dual D-Type Pos-Edge-Trig Flip-Flop, Preset & Clear
Outline No. IC-049

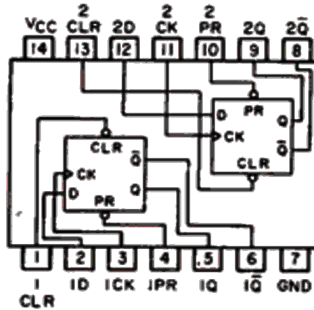

SK74LS77

4-Bit D Latch
Outline No. IC-141



SK7472

AND-Gate J-K Master-Slave Flip-Flops, Preset & Clear
Outline No. IC-048

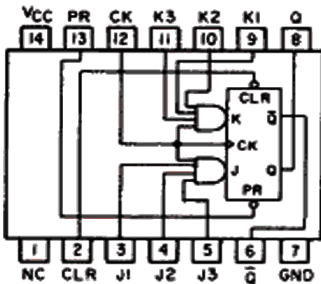

SK7475 SK74LS75

4-Bit Bistable Latch
Outline No. IC-049

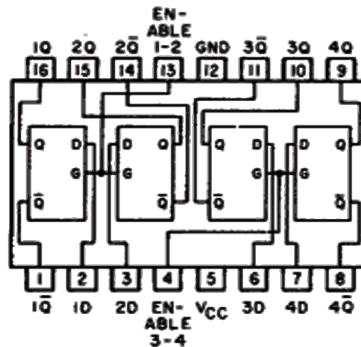

SK74LS78

Dual JK Flip-Flop
Outline No. IC-141

