

Silicon Epitaxial Planar Z-Diodes

Features

- Saving space
- Hermetic sealed parts
- Fits onto SOD 323 / SOT 23 footprints
- Electrical data identical with the devices BZT55B... / TZMB...
- Very sharp reverse characteristic
- Low reverse current level
- Very high stability
- Low noise
- Available with tighter tolerances
- V_Z -tolerance $\pm 2\%$

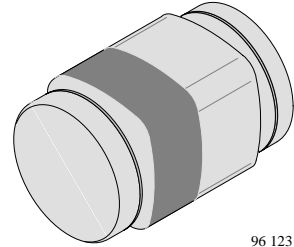

96 12315

Applications

Voltage stabilization

Absolute Maximum Ratings

$T_j = 25^\circ\text{C}$

Parameter	Test Conditions	Type	Symbol	Value	Unit
Power dissipation	$R_{thJA} \leq 300\text{K/W}$		P_V	500	mW
Z-current			I_Z	P_V/V_Z	mA
Junction temperature			T_j	175	$^\circ\text{C}$
Storage temperature range			T_{stg}	-65...+175	$^\circ\text{C}$

Maximum Thermal Resistance

$T_j = 25^\circ\text{C}$

Parameter	Test Conditions	Symbol	Value	Unit
Junction ambient	mounted on epoxy-glass hard tissue, Fig. 1	R_{thJA}	500	K/W
Junction tie point	35 μm copper clad, 0.9 mm ² copper area per electrode	R_{thJL}	300	K/W

Electrical Characteristics

$T_j = 25^\circ\text{C}$

Parameter	Test Conditions	Type	Symbol	Min	Typ	Max	Unit
Forward voltage	$I_F=200\text{mA}$		V_F			1.5	V

BZM55B...

Vishay Telefunken



Type	V _{Znom}	I _{ZT}	for V _{ZT} and	r _{ZT}	r _{ZIK} at	I _{ZK}	I _R and I _R at	V _R	TK _{VZ}
BZM55B...	V	mA	V	Ω	Ω	mA	μA μA ²)	V	%/K
2V4	2.4	5	2.35 to 2.45	< 85	< 600	1	< 100 < 50	1	-0.09 to -0.06
2V7	2.7	5	2.64 to 2.76	< 85	< 600	1	< 10 < 50	1	-0.09 to -0.06
3V0	3.0	5	2.94 to 3.06	< 90	< 600	1	< 4 < 40	1	-0.08 to -0.05
3V3	3.3	5	3.24 to 3.36	< 90	< 600	1	< 2 < 40	1	-0.08 to -0.05
3V6	3.6	5	3.52 to 3.68	< 90	< 600	1	< 2 < 40	1	-0.08 to -0.05
3V9	3.9	5	3.82 to 3.98	< 90	< 600	1	< 2 < 40	1	-0.08 to -0.05
4V3	4.3	5	4.22 to 4.38	< 90	< 600	1	< 1 < 20	1	-0.06 to -0.03
4V7	4.7	5	4.60 to 4.80	< 80	< 600	1	< 0.5 < 10	1	-0.05 to +0.02
5V1	5.1	5	5.00 to 5.20	< 60	< 550	1	< 0.1 < 2	1	-0.02 to +0.02
5V6	5.6	5	5.48 to 5.72	< 40	< 450	1	< 0.1 < 2	1	-0.05 to +0.05
6V2	6.2	5	6.08 to 6.32	< 10	< 200	1	< 0.1 < 2	2	0.03 to 0.06
6V8	6.8	5	6.66 to 6.94	< 8	< 150	1	< 0.1 < 2	3	0.03 to 0.07
7V5	7.5	5	7.35 to 7.65	< 7	< 50	1	< 0.1 < 2	5	0.03 to 0.07
8V2	8.2	5	8.04 to 8.36	< 7	< 50	1	< 0.1 < 2	6.2	0.03 to 0.08
9V1	9.1	5	8.92 to 9.28	< 10	< 50	1	< 0.1 < 2	6.8	0.03 to 0.09
10	10	5	9.80 to 10.20	< 15	< 70	1	< 0.1 < 2	7.5	0.03 to 0.1
11	11	5	10.78 to 11.22	< 20	< 70	1	< 0.1 < 2	8.2	0.03 to 0.11
12	12	5	11.76 to 12.24	< 20	< 90	1	< 0.1 < 2	9.1	0.03 to 0.11
13	13	5	12.74 to 13.26	< 26	< 110	1	< 0.1 < 2	10	0.03 to 0.11
15	15	5	14.70 to 15.30	< 30	< 110	1	< 0.1 < 2	11	0.03 to 0.11
16	16	5	15.70 to 16.30	< 40	< 170	1	< 0.1 < 2	12	0.03 to 0.11
18	18	5	17.64 to 18.36	< 50	< 170	1	< 0.1 < 2	13	0.03 to 0.11
20	20	5	19.60 to 20.40	< 55	< 220	1	< 0.1 < 2	15	0.03 to 0.11
22	22	5	21.55 to 22.45	< 55	< 220	1	< 0.1 < 2	16	0.04 to 0.12
24	24	5	23.5 to 24.5	< 80	< 220	1	< 0.1 < 2	18	0.04 to 0.12
27	27	5	26.4 to 27.6	< 80	< 220	1	< 0.1 < 2	20	0.04 to 0.12
30	30	5	29.4 to 30.6	< 80	< 220	1	< 0.1 < 2	22	0.04 to 0.12
33	33	5	32.4 to 33.6	< 80	< 220	1	< 0.1 < 2	24	0.04 to 0.12
36	36	5	35.3 to 36.7	< 80	< 220	1	< 0.1 < 2	27	0.04 to 0.12
39	39	2.5	38.2 to 39.8	< 90	< 500	1	< 0.1 < 5	30	0.04 to 0.12
43	43	2.5	42.1 to 43.9	< 90	< 600	0.5	< 0.1 < 5	33	0.04 to 0.12
47	47	2.5	46.1 to 47.9	< 110	< 700	0.5	< 0.1 < 5	36	0.04 to 0.12
51	51	2.5	50.0 to 52.0	< 125	< 700	0.5	< 0.1 < 10	39	0.04 to 0.12
56	56	2.5	54.9 to 57.1	< 135	< 1000	0.5	< 0.1 < 10	43	0.04 to 0.12
62	62	2.5	60.8 to 63.2	< 150	< 1000	0.5	< 0.1 < 10	47	0.04 to 0.12
68	68	2.5	66.6 to 69.4	< 200	< 1000	0.5	< 0.1 < 10	51	0.04 to 0.12
75	75	2.5	73.5 to 76.5	< 250	< 1500	0.5	< 0.1 < 10	56	0.04 to 0.12

Characteristics ($T_j = 25^\circ\text{C}$ unless otherwise specified)

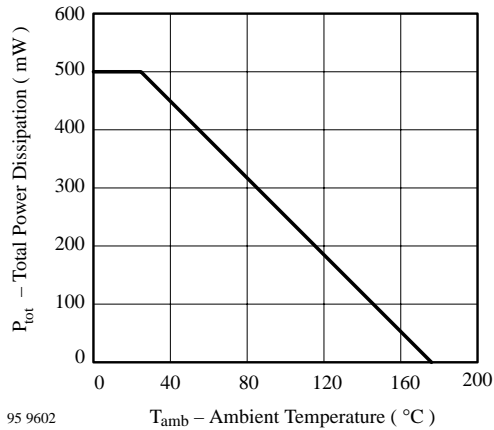

95 9602

Total Power Dissipation vs. Ambient Temperature

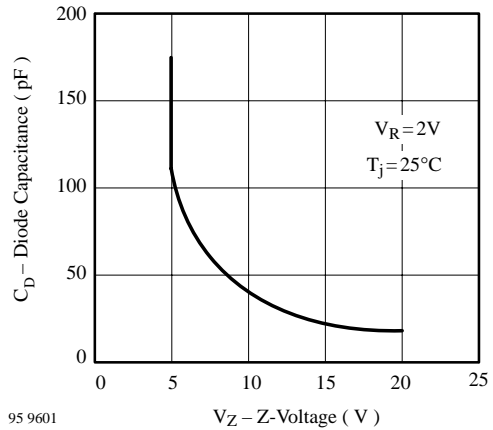

95 9601

Diode Capacitance vs. Z-Voltage

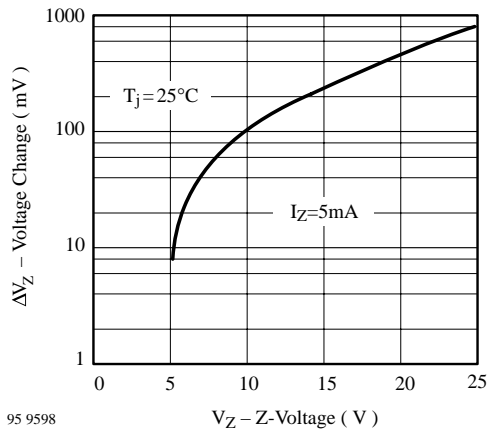

95 9598

Typical Change of Working Voltage under Operating Conditions at $T_{\text{amb}} = 25^\circ\text{C}$

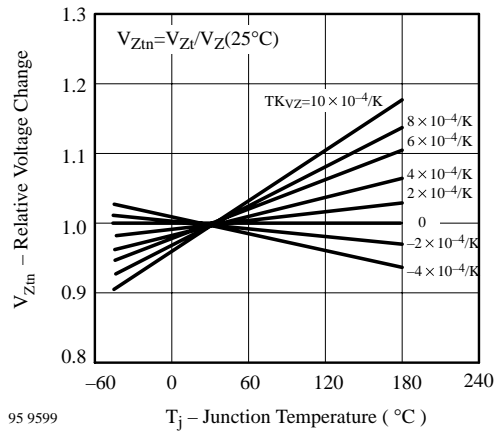

95 9599

Typical Change of Working Voltage vs. Junction Temperature

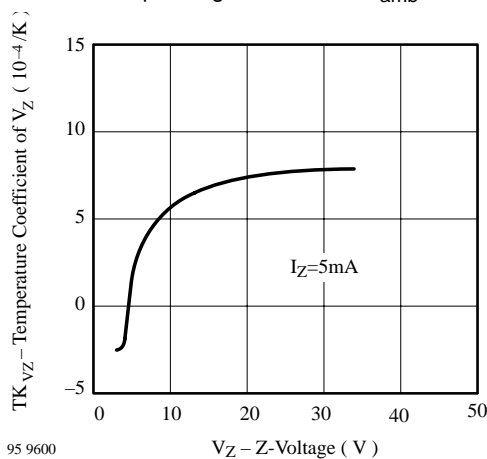

95 9600

Temperature Coefficient of V_Z vs. Z-Voltage

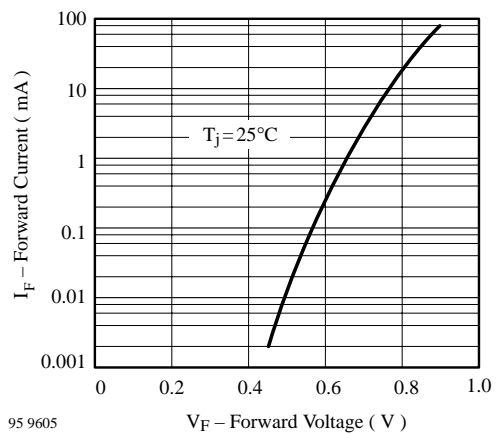

95 9605

Forward Current vs. Forward Voltage

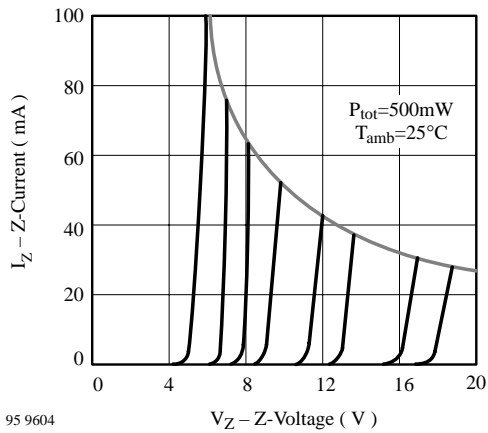

95 9604

Z-Current vs. Z-Voltage

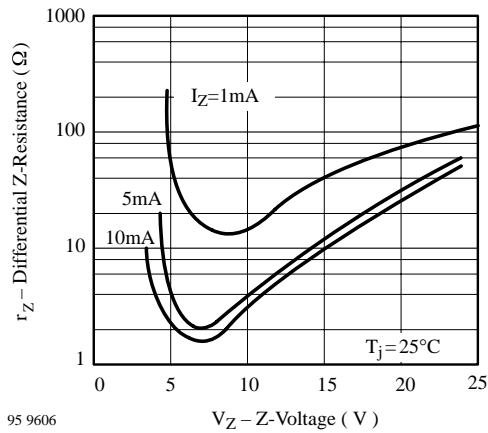

95 9606

Differential Z-Resistance vs. Z-Voltage

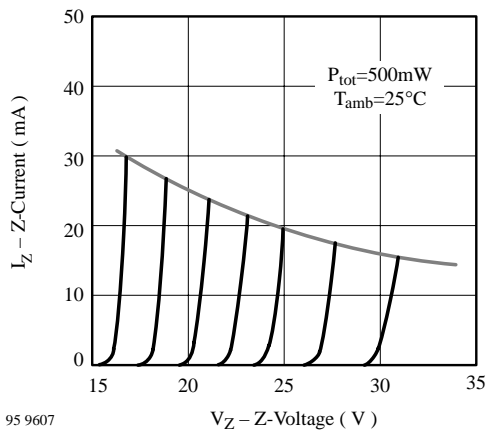

95 9607

Z-Current vs. Z-Voltage

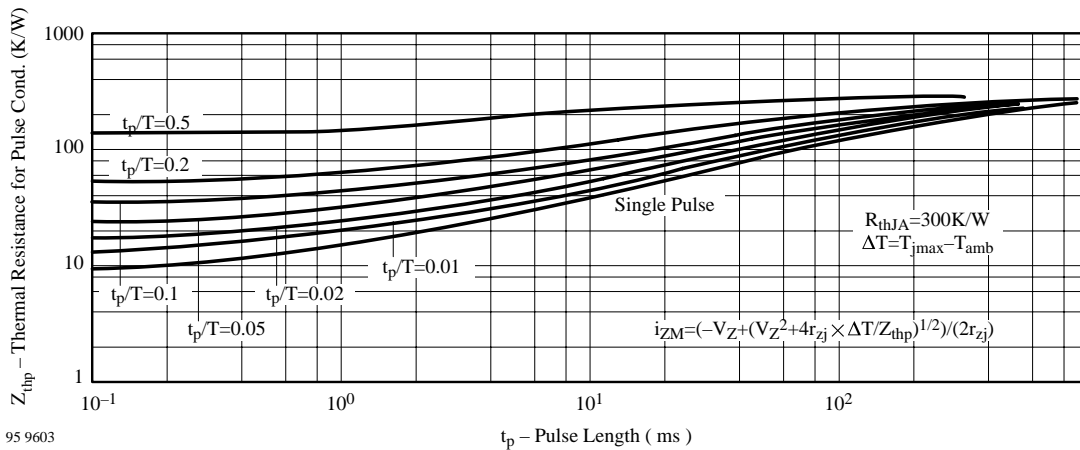

95 9603

Thermal Response

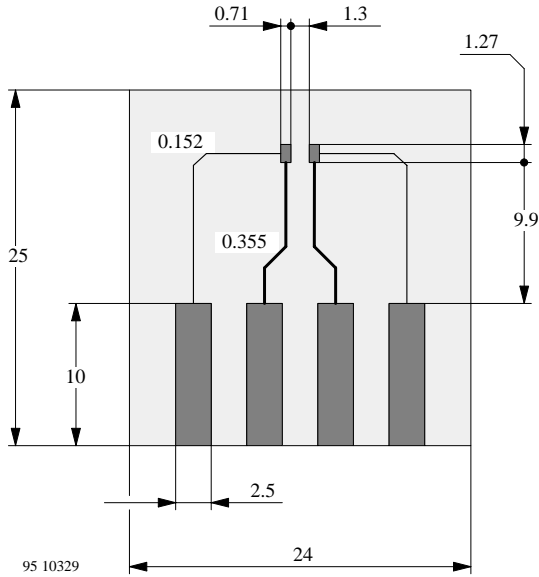

Board for R_{thJA} definition (in mm)
 Reflow Soldering

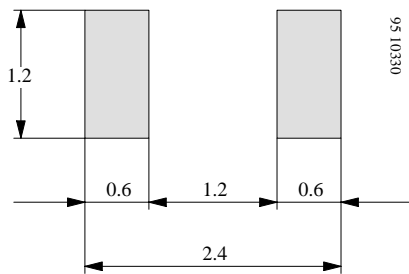

Recommended foot pads (in mm)

Dimensions in mm

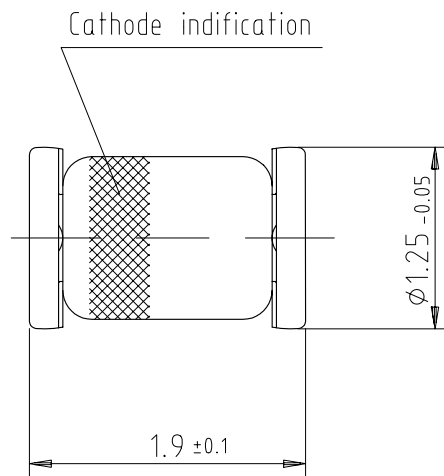

Glass case
 Micro MELF

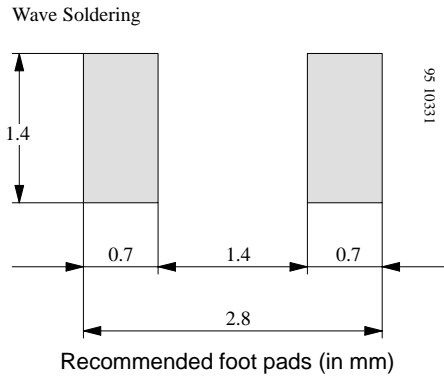

Recommended foot pads (in mm)

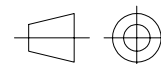
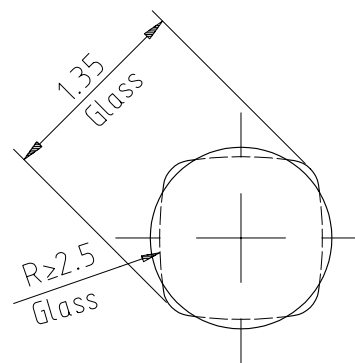

96 12072
 technical drawings
 according to DIN
 specifications

Ozone Depleting Substances Policy Statement

It is the policy of **Vishay Semiconductor GmbH** to

1. Meet all present and future national and international statutory requirements.
2. Regularly and continuously improve the performance of our products, processes, distribution and operating systems with respect to their impact on the health and safety of our employees and the public, as well as their impact on the environment.

It is particular concern to control or eliminate releases of those substances into the atmosphere which are known as ozone depleting substances (ODSs).

The Montreal Protocol (1987) and its London Amendments (1990) intend to severely restrict the use of ODSs and forbid their use within the next ten years. Various national and international initiatives are pressing for an earlier ban on these substances.

Vishay Semiconductor GmbH has been able to use its policy of continuous improvements to eliminate the use of ODSs listed in the following documents.

1. Annex A, B and list of transitional substances of the Montreal Protocol and the London Amendments respectively
2. Class I and II ozone depleting substances in the Clean Air Act Amendments of 1990 by the Environmental Protection Agency (EPA) in the USA
3. Council Decision 88/540/EEC and 91/690/EEC Annex A, B and C (transitional substances) respectively.

Vishay Semiconductor GmbH can certify that our semiconductors are not manufactured with ozone depleting substances and do not contain such substances.

We reserve the right to make changes to improve technical design and may do so without further notice.

Parameters can vary in different applications. All operating parameters must be validated for each customer application by the customer. Should the buyer use Vishay-Telefunken products for any unintended or unauthorized application, the buyer shall indemnify Vishay-Telefunken against all claims, costs, damages, and expenses, arising out of, directly or indirectly, any claim of personal damage, injury or death associated with such unintended or unauthorized use.

Vishay Semiconductor GmbH, P.O.B. 3535, D-74025 Heilbronn, Germany
Telephone: 49 (0)7131 67 2831, Fax number: 49 (0)7131 67 2423