

# Transformers for Inverter or Converter TR Series

Coils, Filters

## TR9-B-S

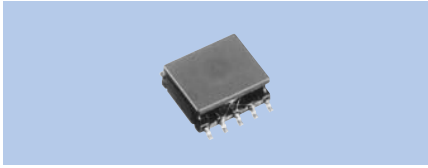

**Specifications**

- (1) -
- (2) 10~300kHz
- (3) 1W

**Features**

- SMD
- 500pcs./Reel

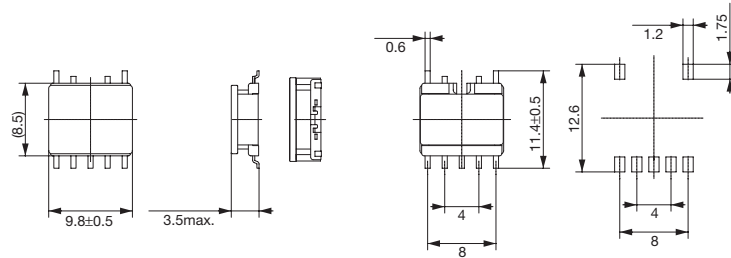

## TR11-D-S

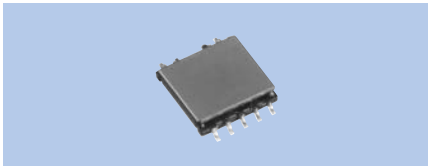

**Specifications**

- (1) -
- (2) 10~300kHz
- (3) 1W

**Features**

- SMD
- 500pcs./Reel

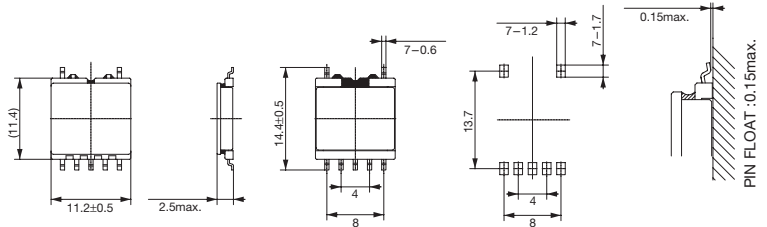

## TR11-A-S

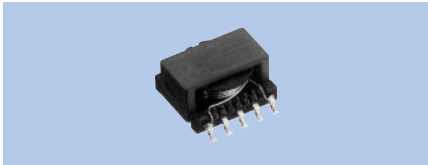

**Specifications**

- (1) -
- (2) 10~300kHz
- (3) 2W

**Features**

- SMD
- 500pcs./Reel

Dimensions marked with an asterisk(x) include adhesive overflow.

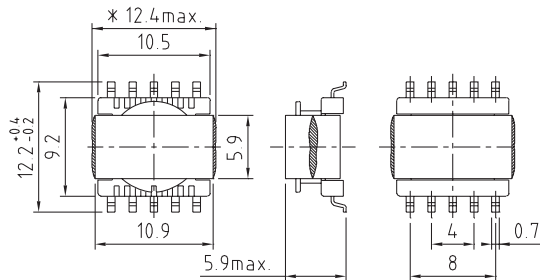

## TR11-A1-S

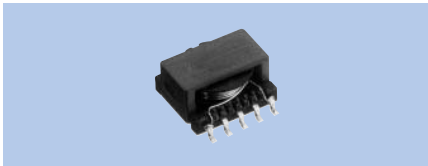

**Specifications**

- (1) -
- (2) 10~300kHz
- (3) 1.5W

**Features**

- SMD
- 500pcs./Reel

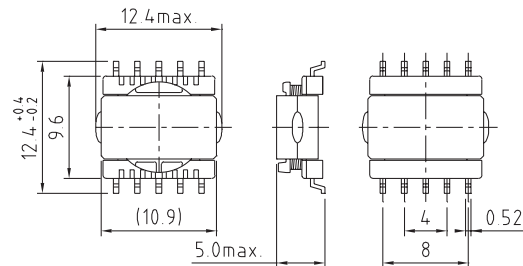

- (1) Inductance
- (2) Operational frequency
- (3) Power Capacity

### TR11-C-S

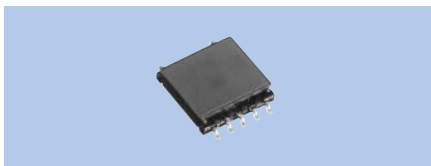

**Specifications**

- (1) -
- (2) 10~300kHz
- (3) 1.3W

**Features**

- SMD
- 500pcs./Reel

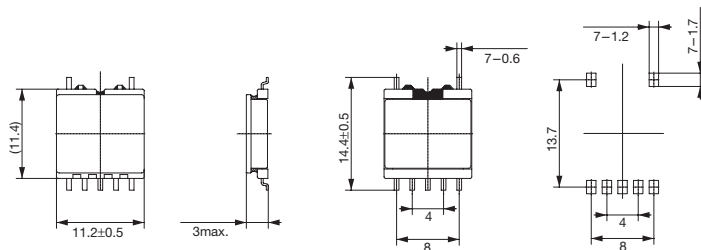

### TR14-A-S

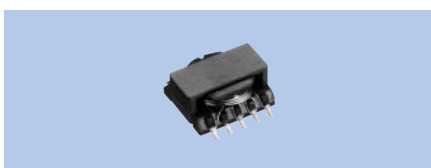

**Specifications**

- (1) -
- (2) 10~300kHz
- (3) 3.0W

**Features**

- SMD

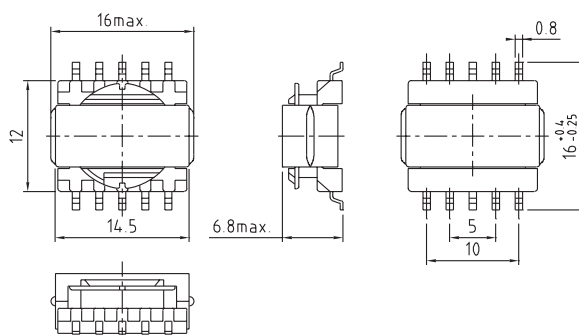

### TR14-C-S



**Specifications**

- (1) -
- (2) 10~300kHz
- (3) 2W

**Features**

- SMD

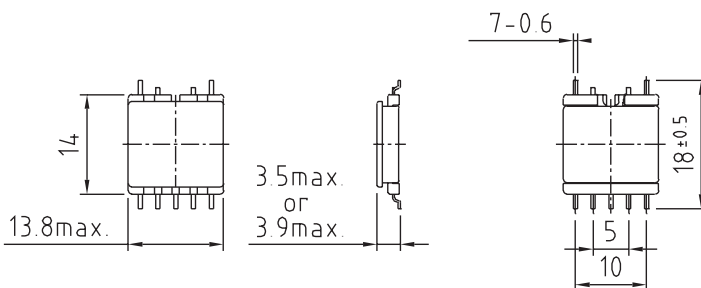

### TR21-A-S

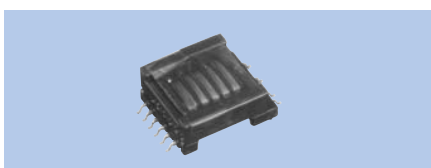

**Specifications**

- (1) -
- (2) 10~300kHz
- (3) 8W

**Features**

- SMD

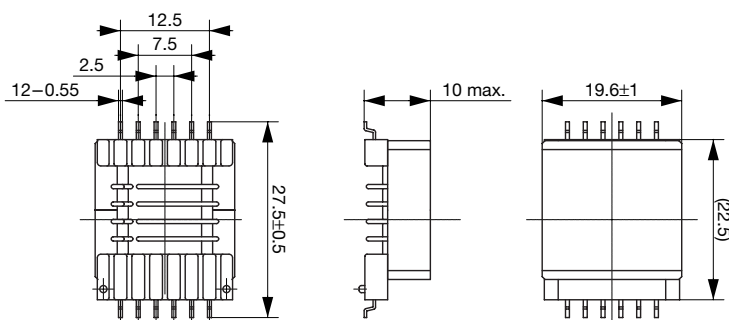

- (1) Inductance
- (2) Operational frequency
- (3) Power Capacity

## TR25-A-S

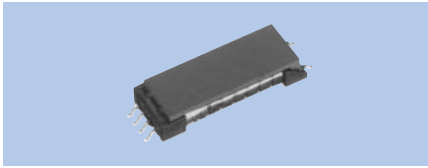

**Specifications**  
 (1) –  
 (2) 10~300kHz  
 (3) 4W

**Features**  
 SMD

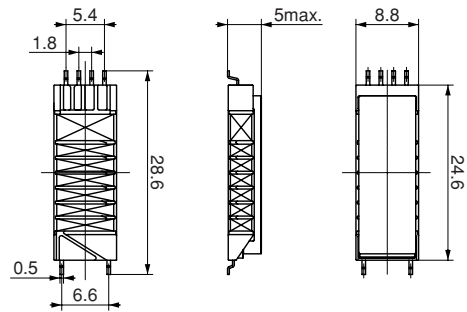

## TR26-A-S

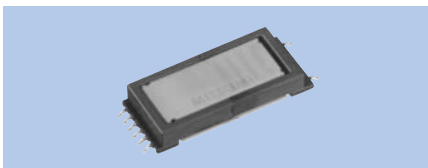

**Specifications**  
 (1) –  
 (2) 10~300kHz  
 (3) 3W

**Features**  
 SMD

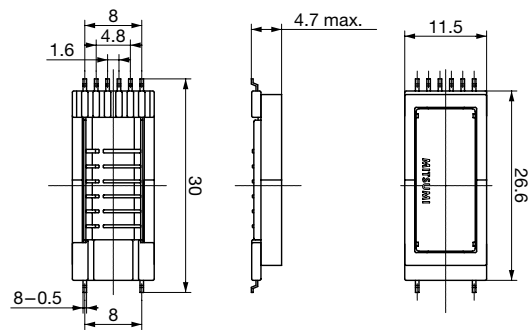

## TR29-A-S

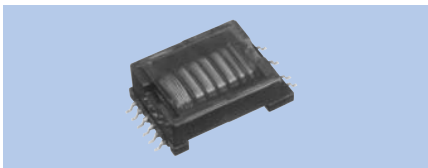

**Specifications**  
 (1) –  
 (2) 10~300kHz  
 (3) 12W

**Features**  
 SMD

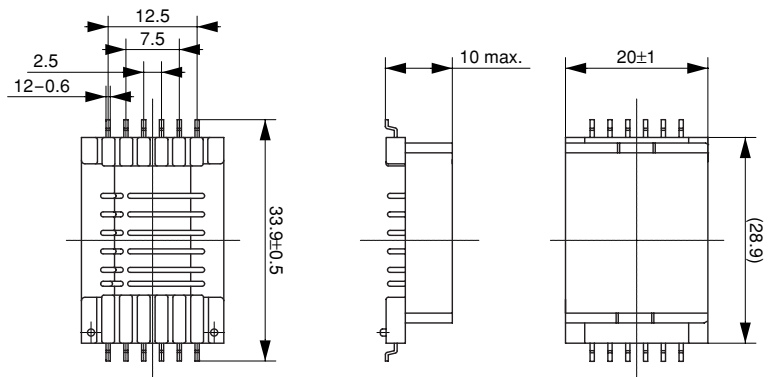

(1) Inductance  
 (2) Operational frequency  
 (3) Power Capacity