

LP38691/LP38693

500mA Low Dropout CMOS Linear Regulators

Stable with Ceramic Output Capacitors

General Description

The LP38691/3 low dropout CMOS linear regulators provide tight output tolerance (2.0% typical), extremely low dropout voltage (250 mV @ 500mA load current, $V_{OUT} = 5V$), and excellent AC performance utilizing ultra low ESR ceramic output capacitors.

The low thermal resistance of the LLP, SOT-223 and T0-252 packages allow the full operating current to be used even in high ambient temperature environments.

The use of a PMOS power transistor means that no DC base drive current is required to bias it allowing ground pin current to remain below 100 μA regardless of load current, input voltage, or operating temperature.

Dropout Voltage: 250 mV (typ) @ 500mA (typ. 5V out).

Ground Pin Current: 55 μA (typ) at full load.

Precision Output Voltage: 2.0% (25°C) accuracy.

Features

- 2.0% output accuracy (25°C)
- Low dropout voltage: 250 mV @ 500mA (typ, 5V out)
- Wide input voltage range (2.7V to 10V)
- Precision (trimmed) bandgap reference
- Guaranteed specs for -40°C to +125°C
- 1 μA off-state quiescent current
- Thermal overload protection
- Foldback current limiting
- T0-252, SOT-223 and 6-Lead LLP packages
- Enable pin (LP38693)

Applications

- Hard Disk Drives
- Notebook Computers
- Battery Powered Devices
- Portable Instrumentation

Typical Application Circuits

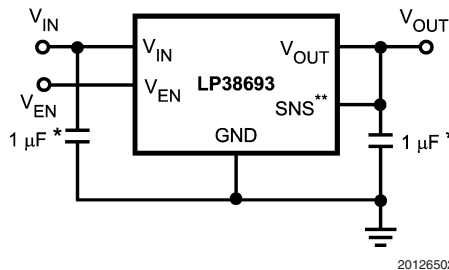
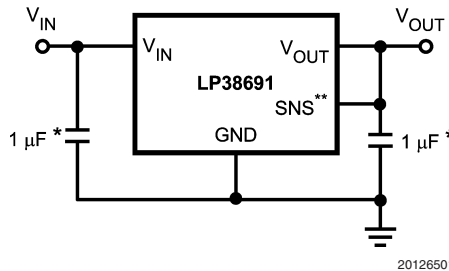

Note: * Minimum value required for stability.

**LLP package devices only.

Connection Diagrams

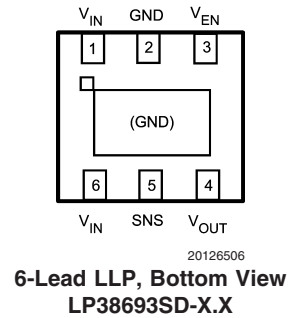
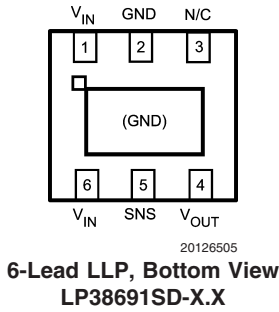
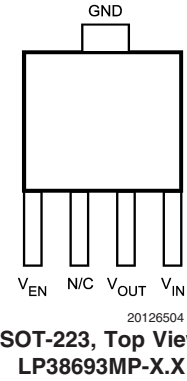
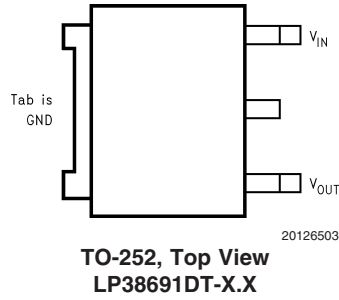

Pin Description

PIN	DESCRIPTION
V_{IN}	This is the input supply voltage to the regulator. For LLP devices, both V_{IN} pins must be tied together for full current operation (250mA maximum per pin).
GND	Circuit ground for the regulator. This is connected to the die through the lead frame, and also functions as the heat sink when the large ground pad is soldered down to a copper plane.
SNS	Output sense pin allows remote sensing at the load which will eliminate the error in output voltage due to voltage drops caused by the resistance in the traces between the regulator and the load. This pin must be tied to V_{OUT} .
V_{EN}	The enable pin allows the part to be turned ON and OFF by pulling this pin high or low.
V_{OUT}	Regulated output voltage

Ordering Information

Order Number	Package Marking	Package Type	Package Drawing	Supplied As
LP38691SD-1.8	L118B	6-Lead LLP	SDE06A	1000 Units Tape and Reel
LP38691SD-2.5	L119B	6-Lead LLP	SDE06A	1000 Units Tape and Reel
LP38691SD-3.3	L120B	6-Lead LLP	SDE06A	1000 Units Tape and Reel
LP38691SD-5.0	L121B	6-Lead LLP	SDE06A	1000 Units Tape and Reel
LP38691DT-1.8	LP38691DT-1.8	TO-252	TD03B	Available Soon
LP38691DT-2.5	LP38691DT-2.5	TO-252	TD03B	Available Soon
LP38691DT-3.3	LP38691DT-3.3	TO-252	TD03B	Available Soon
LP38691DT-5.0	LP38691DT-5.0	TO-252	TD03B	Available Soon
LP38693SD-1.8	L128B	6-Lead LLP	SDE06A	1000 Units Tape and Reel
LP38693SD-2.5	L129B	6-Lead LLP	SDE06A	1000 Units Tape and Reel
LP38693SD-3.3	L130B	6-Lead LLP	SDE06A	1000 Units Tape and Reel
LP38693SD-5.0	L131B	6-Lead LLP	SDE06A	1000 Units Tape and Reel
LP38693MP-1.8	LJVB	SOT-223	MP05A	1000 Units Tape and Reel

Ordering Information (Continued)

Order Number	Package Marking	Package Type	Package Drawing	Supplied As
LP38693MP-2.5	LJXB	SOT-223	MP05A	1000 Units Tape and Reel
LP38693MP-3.3	LJYB	SOT-223	MP05A	1000 Units Tape and Reel
LP38693MP-5.0	LJZB	SOT-223	MP05A	1000 Units Tape and Reel
LP38691SDX-1.8	L118B	6-Lead LLP	SDE06A	4500 Units Tape and Reel
LP38691SDX-2.5	L119B	6-Lead LLP	SDE06A	4500 Units Tape and Reel
LP38691SDX-3.3	L120B	6-Lead LLP	SDE06A	4500 Units Tape and Reel
LP38691SDX-5.0	L121B	6-Lead LLP	SDE06A	4500 Units Tape and Reel
LP38691DTX-1.8	LP38691DT-1.8	TO-252	TD03B	Available Soon
LP38691DTX-2.5	LP38691DT-2.5	TO-252	TD03B	Available Soon
LP38691DTX-3.3	LP38691DT-3.3	TO-252	TD03B	Available Soon
LP38691DTX-5.0	LP38691DT-5.0	TO-252	TD03B	Available Soon
LP38693SDX-1.8	L128B	6-Lead LLP	SDE06A	4500 Units Tape and Reel
LP38693SDX-2.5	L129B	6-Lead LLP	SDE06A	4500 Units Tape and Reel
LP38693SDX-3.3	L130B	6-Lead LLP	SDE06A	4500 Units Tape and Reel
LP38693SDX-5.0	L131B	6-Lead LLP	SDE06A	4500 Units Tape and Reel
LP38693MPX-1.8	LJVB	SOT-223	MP05A	2000 Units Tape and Reel
LP38693MPX-2.5	LJXB	SOT-223	MP05A	2000 Units Tape and Reel
LP38693MPX-3.3	LJYB	SOT-223	MP05A	2000 Units Tape and Reel
LP38693MPX-5.0	LJZB	SOT-223	MP05A	2000 Units Tape and Reel

Absolute Maximum Ratings (Note 1)

If Military/Aerospace specified devices are required, please contact the National Semiconductor Sales Office/Distributors for availability and specifications.

Storage Temperature Range	-65°C to +150°C
Lead Temp. (Soldering, 5 seconds)	260°C
ESD Rating (Note 3)	2 kV
Power Dissipation (Note 2)	Internally Limited
V(max) All pins (with respect to GND)	-0.3V to 12V

I_{OUT}	Internally Limited
Junction Temperature	-40°C to +150°C

Operating Ratings

V_{IN} Supply Voltage	2.7V to 10V
Operating Junction Temperature Range	-40°C to +125°C

Electrical Characteristics Limits in standard typeface are for $T_J = 25^\circ\text{C}$, and limits in **boldface type** apply over the full operating temperature range. Unless otherwise specified: $V_{IN} = V_{OUT} + 1\text{V}$, $C_{IN} = C_{OUT} = 10\ \mu\text{F}$, $I_{LOAD} = 10\text{mA}$. Min/Max limits are guaranteed through testing, statistical correlation, or design.

Symbol	Parameter	Conditions	MIN	TYP (Note 4)	MAX	Units
V_O	Output Voltage Tolerance		-2.0		2.0	% V_{OUT}
		$100\ \mu\text{A} < I_L < 0.5\text{A}$ $V_O + 1\text{V} \leq V_{IN} \leq 10\text{V}$	-4.0		4.0	
$\Delta V_O / \Delta V_{IN}$	Output Voltage Line Regulation (Note 6)	$V_O + 0.5\text{V} \leq V_{IN} \leq 10\text{V}$ $I_L = 25\text{mA}$		0.03	0.1	%/V
$\Delta V_O / \Delta I_L$	Output Voltage Load Regulation (Note 7)	$1\ \text{mA} < I_L < 0.5\text{A}$ $V_{IN} = V_O + 1\text{V}$		1.8	5	%/A
$V_{IN} - V_{OUT}$	Dropout Voltage (Note 8)	$(V_O = 2.5\text{V})$ $I_L = 0.1\text{A}$ $I_L = 0.5\text{A}$		80 430	145 725	mV
		$(V_O = 3.3\text{V})$ $I_L = 0.1\text{A}$ $I_L = 0.5\text{A}$		65 330	110 550	
		$(V_O = 5\text{V})$ $I_L = 0.1\text{A}$ $I_L = 0.5\text{A}$		45 250	100 450	
I_Q	Quiescent Current	$V_{IN} \leq 10\text{V}$, $I_L = 100\ \mu\text{A} - 0.5\text{A}$		55	100	μA
		$V_{EN} \leq 0.4\text{V}$, (LP38693 Only)		0.001	1	
$I_L(\text{MIN})$	Minimum Load Current	$V_{IN} - V_O \leq 4\text{V}$			100	
I_{FB}	Foldback Current Limit	$V_{IN} - V_O > 5\text{V}$		350		mA
		$V_{IN} - V_O < 4\text{V}$		850		
PSRR	Ripple Rejection	$V_{IN} = V_O + 2\text{V}(\text{DC})$, with 1V(p-p) / 120Hz Ripple		55		dB
T_{SD}	Thermal Shutdown Activation (Junction Temp)			160		°C
$T_{SD}(\text{HYST})$	Thermal Shutdown Hysteresis (Junction Temp)			10		

Electrical Characteristics Limits in standard typeface are for $T_J = 25^\circ\text{C}$, and limits in **boldface type** apply over the full operating temperature range. Unless otherwise specified: $V_{IN} = V_{OUT} + 1\text{V}$, $C_{IN} = C_{OUT} = 10\ \mu\text{F}$, $I_{LOAD} = 10\text{mA}$. Min/Max limits are guaranteed through testing, statistical correlation, or design. (Continued)

Symbol	Parameter	Conditions	MIN	TYP (Note 4)	MAX	Units
e_n	Output Noise	BW = 10Hz to 10kHz $V_O = 3.3\text{V}$		0.7		$\mu\text{V}/\sqrt{\text{Hz}}$
V_O (LEAK)	Output Leakage Current	$V_O = V_O(\text{NOM}) + 1\text{V} @ 10V_{IN}$		0.5	12	μA
V_{EN}	Enable Voltage (LP38693 Only)	Output = OFF			0.4	V
		Output = ON, $V_{IN} = 4\text{V}$	1.8			
		Output = ON, $V_{IN} = 6\text{V}$	3.0			
		Output = ON, $V_{IN} = 10\text{V}$	4.0			
I_{EN}	Enable Pin Leakage (LP38693 Only)	$V_{EN} = 0\text{V}$ or 10V , $V_{IN} = 10\text{V}$	-1	0.001	1	μA

Note 1: Absolute maximum ratings indicate limits beyond which damage to the component may occur. Operating ratings indicate conditions for which the device is intended to be functional, but do not guarantee specific performance limits. For guaranteed specifications, see Electrical Characteristics. Specifications do not apply when operating the device outside of its rated operating conditions.

Note 2: At elevated temperatures, device power dissipation must be derated based on package thermal resistance and heatsink values (if a heatsink is used). The junction-to-ambient thermal resistance (θ_{J-A}) for the TO-252 is approximately $90^\circ\text{C}/\text{W}$ for a PC board mounting with the device soldered down to minimum copper area (less than 0.1 square inch). If one square inch of copper is used as a heat dissipator for the TO-252, the θ_{J-A} drops to approximately $50^\circ\text{C}/\text{W}$. The SOT-223 package has a θ_{J-A} of approximately $125^\circ\text{C}/\text{W}$ when soldered down to a minimum sized pattern (less than 0.1 square inch) and approximately $70^\circ\text{C}/\text{W}$ when soldered to a copper area of one square inch. The θ_{J-A} values for the LLP package are also dependent on trace area, copper thickness, and the number of thermal vias used (refer to application note AN-1187). If power dissipation causes the junction temperature to exceed specified limits, the device will go into thermal shutdown.

Note 3: ESD is tested using the human body model which is a 100pF capacitor discharged through a 1.5k resistor into each pin.

Note 4: Typical numbers represent the most likely parametric norm for 25°C operation.

Note 5: If used in a dual-supply system where the regulator load is returned to a negative supply, the output pin must be diode clamped to ground.

Note 6: Output voltage line regulation is defined as the change in output voltage from nominal value resulting from a change in input voltage.

Note 7: Output voltage load regulation is defined as the change in output voltage from nominal value as the load current increases from 1mA to full load.

Note 8: Dropout voltage is defined as the minimum input to output differential required to maintain the output within 100mV of nominal value.

Block Diagrams

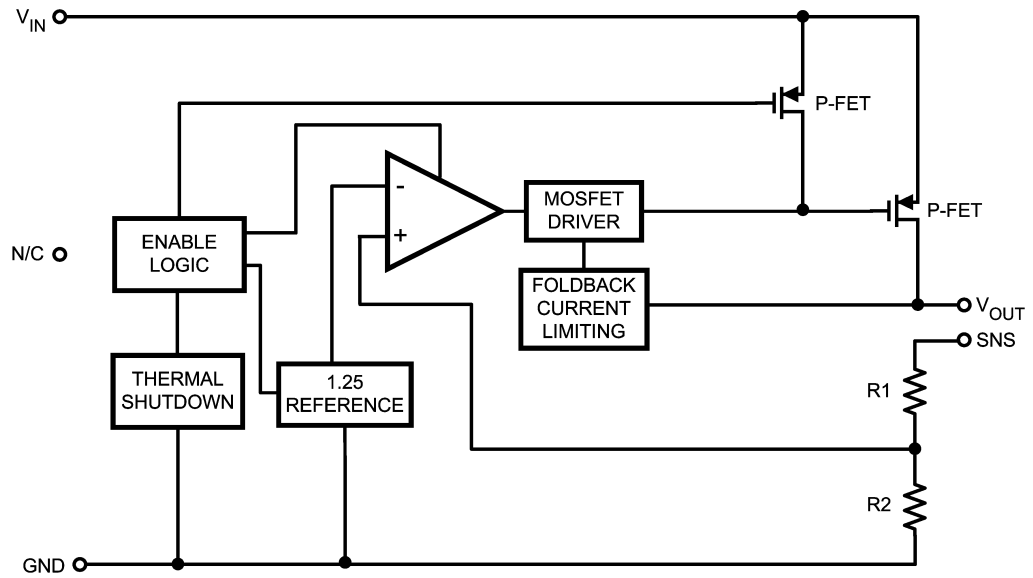

20126507

FIGURE 1. LP38691 Functional Diagram (LLP)

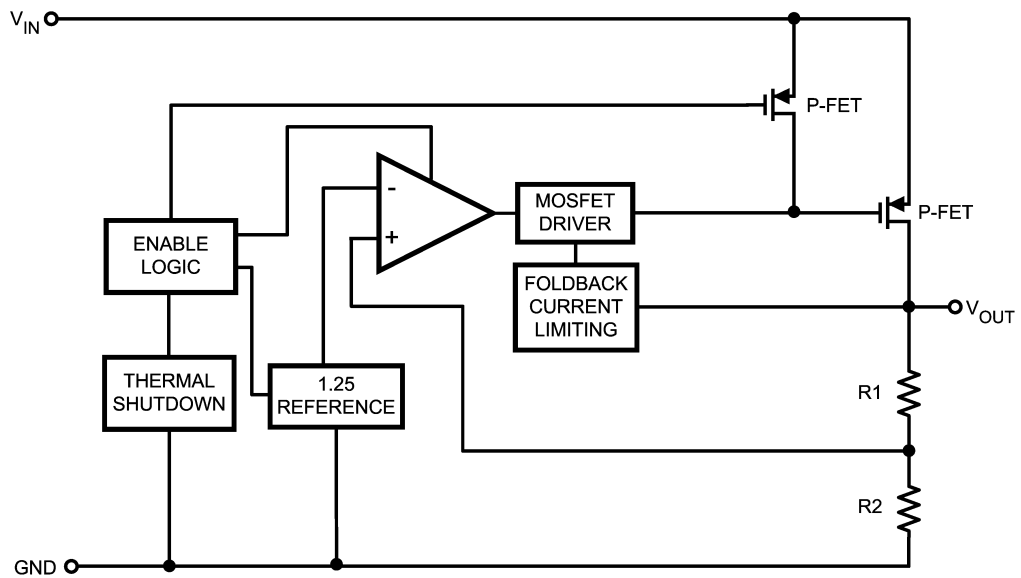

20126508

FIGURE 2. LP38691 Functional Diagram (TO-252)

Typical Performance Characteristics Unless otherwise specified: $T_J = 25^\circ\text{C}$, $C_{IN} = C_{OUT} = 10\ \mu\text{F}$, enable pin is tied to V_{IN} (LP38693 only), $V_{OUT} = 1.8\text{V}$, $V_{IN} = V_{OUT} + 1\text{V}$, $I_L = 10\text{mA}$.

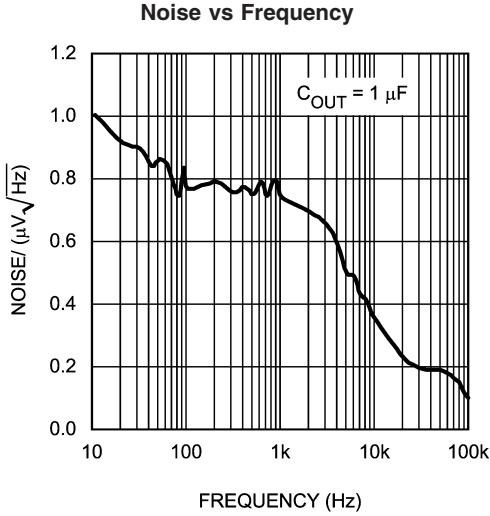

20126535

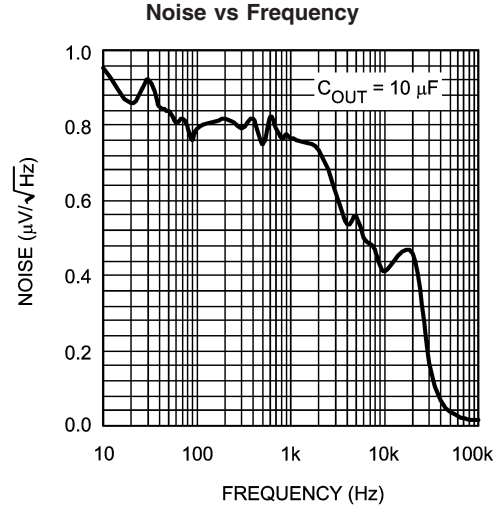

20126536

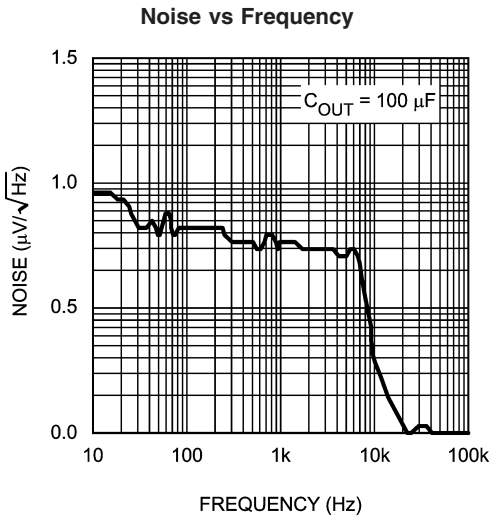

20126537

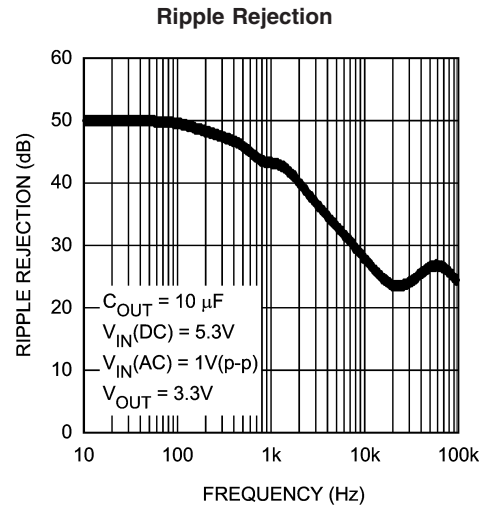

20126518

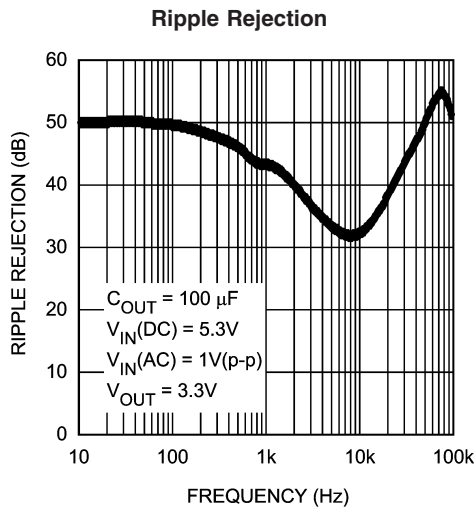

20126520

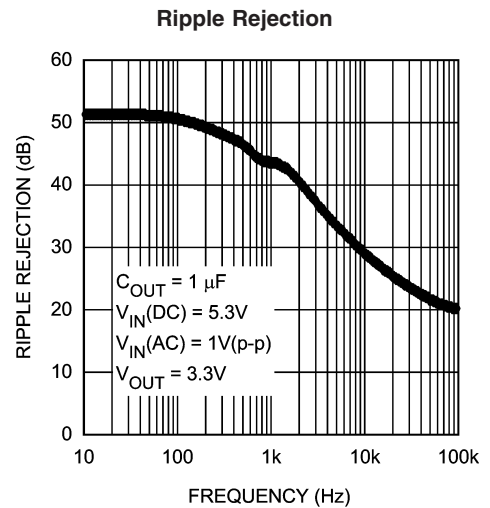

20126522

Typical Performance Characteristics Unless otherwise specified: $T_J = 25^\circ\text{C}$, $C_{IN} = C_{OUT} = 10\ \mu\text{F}$, enable pin is tied to V_{IN} (LP38693 only), $V_{OUT} = 1.8\text{V}$, $V_{IN} = V_{OUT} + 1\text{V}$, $I_L = 10\text{mA}$. (Continued)

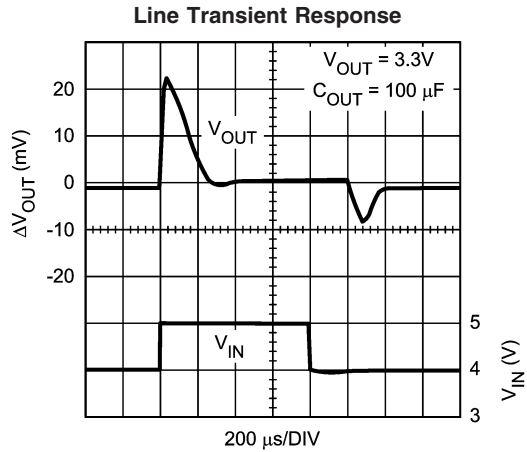

20126524

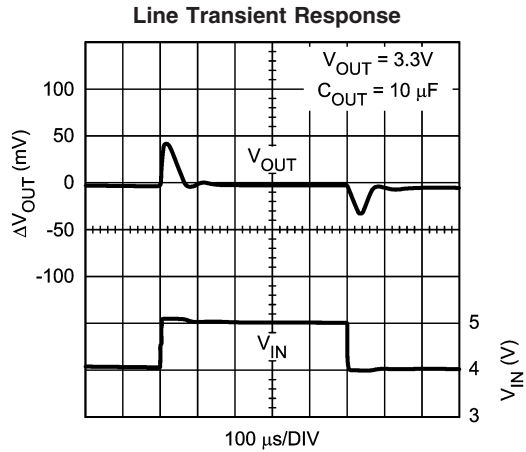

20126526

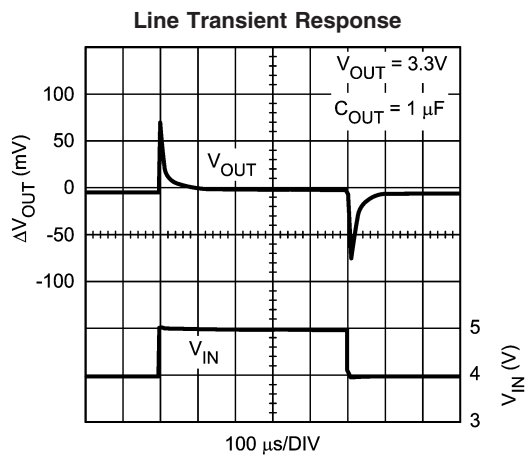

20126528

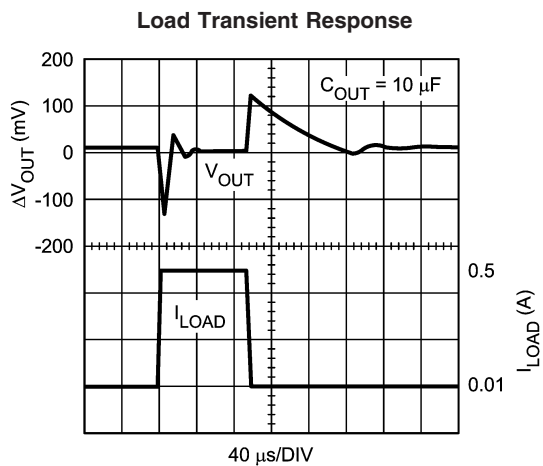

20126542

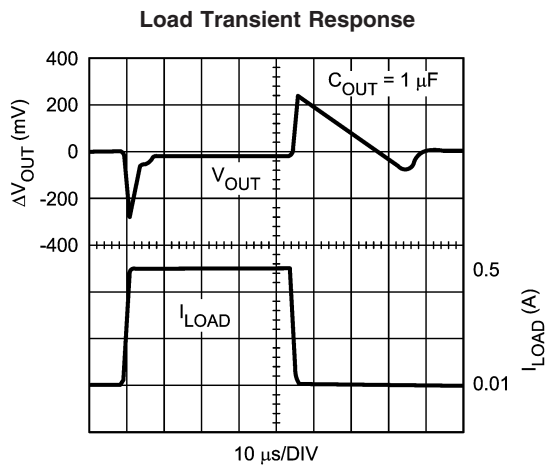

20126544

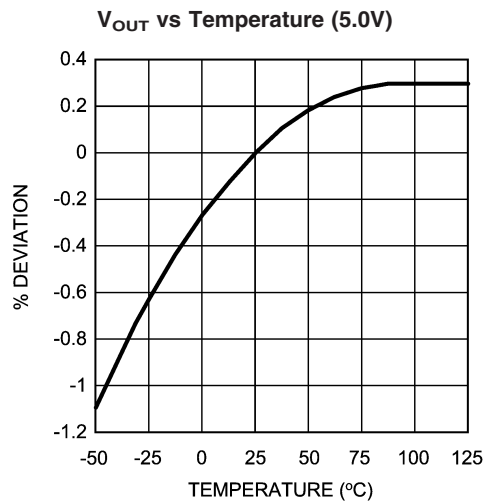

20126530

Typical Performance Characteristics Unless otherwise specified: $T_J = 25^\circ\text{C}$, $C_{IN} = C_{OUT} = 10\ \mu\text{F}$, enable pin is tied to V_{IN} (LP38693 only), $V_{OUT} = 1.8\text{V}$, $V_{IN} = V_{OUT} + 1\text{V}$, $I_L = 10\text{mA}$. (Continued)

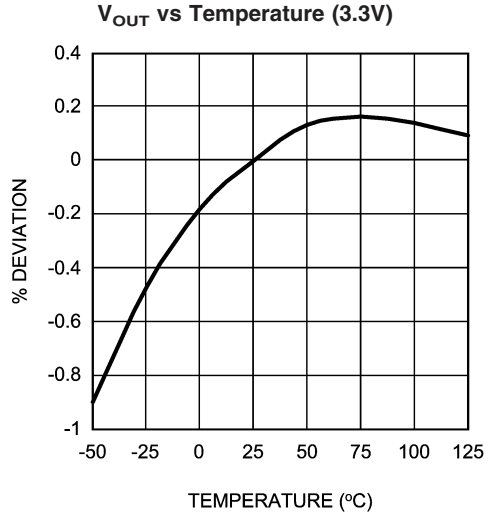

20126531

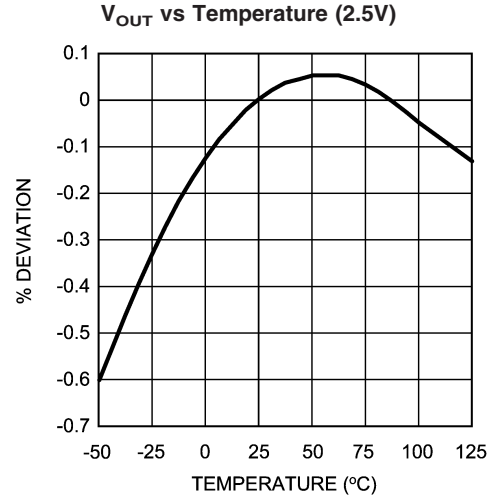

20126532

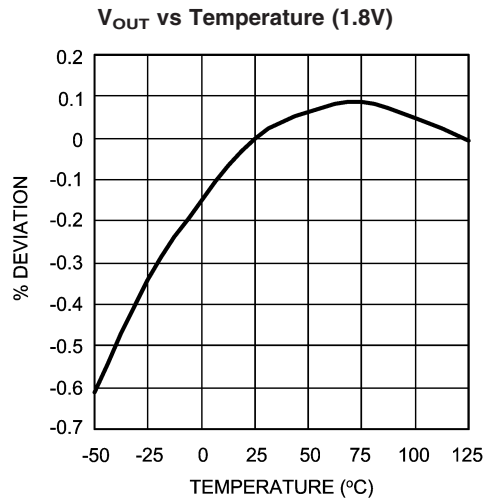

20126533

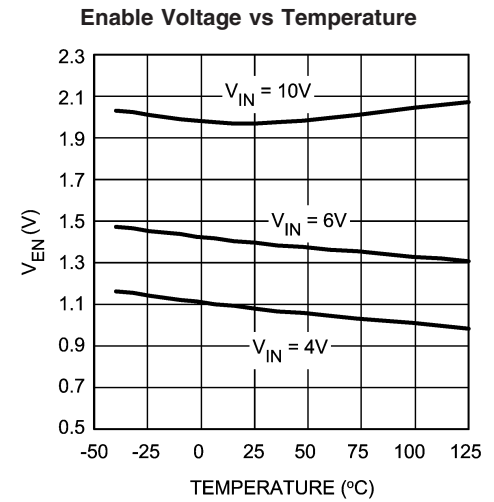

20126552

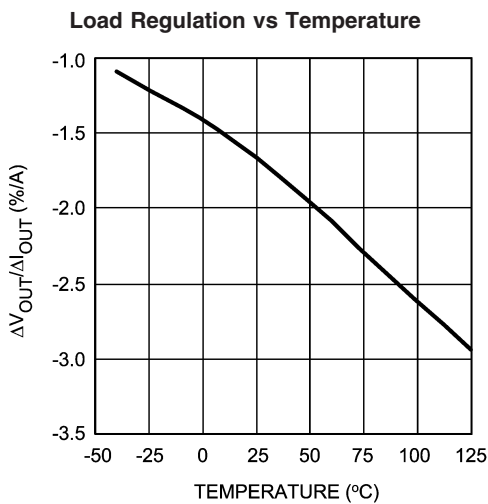

20126553

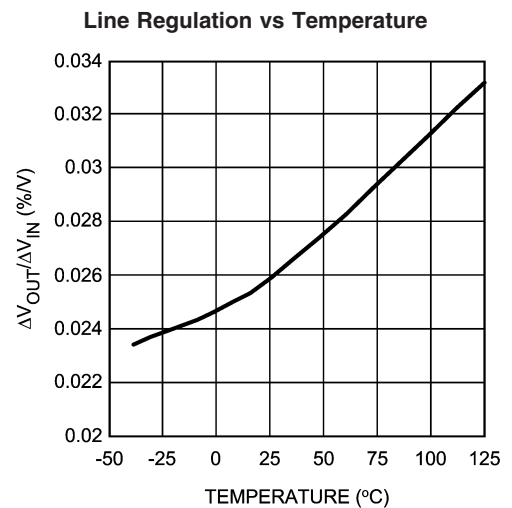

20126554

Typical Performance Characteristics Unless otherwise specified: $T_J = 25^\circ\text{C}$, $C_{IN} = C_{OUT} = 10\ \mu\text{F}$, enable pin is tied to V_{IN} (LP38693 only), $V_{OUT} = 1.8\text{V}$, $V_{IN} = V_{OUT} + 1\text{V}$, $I_L = 10\text{mA}$. (Continued)

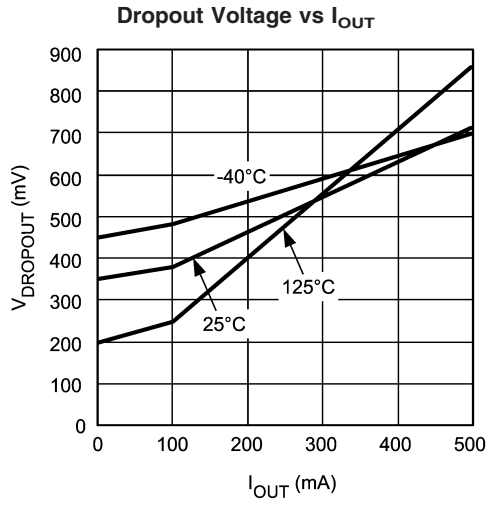
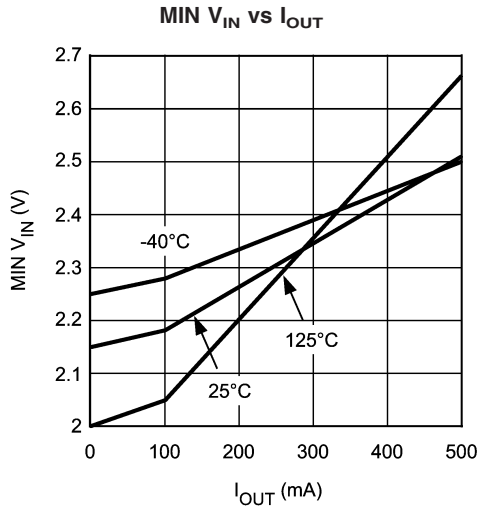

Application Hints

EXTERNAL CAPACITORS

Like any low-dropout regulator, external capacitors are required to assure stability. These capacitors must be correctly selected for proper performance.

INPUT CAPACITOR: An input capacitor of at least $1\mu\text{F}$ is required (ceramic recommended). The capacitor must be located not more than one centimeter from the input pin and returned to a clean analog ground.

OUTPUT CAPACITOR: An output capacitor is required for loop stability. It must be located less than 1 centimeter from the device and connected directly to the output and ground pins using traces which have no other currents flowing through them.

The minimum amount of output capacitance that can be used for stable operation is $1\mu\text{F}$. Ceramic capacitors are recommended (the LP38691/3 was designed for use with ultra low ESR capacitors). The LP38691/3 is stable with any output capacitor ESR between zero and 100 Ohms.

ENABLE PIN (LP38693 only): The LP38693 has an enable pin which turns the regulator output on and off. Pulling the enable pin down to a logic low will turn the part off. The voltage the pin has to be pulled up to in order to assure the part is on depends on input voltage (refer to Electrical Characteristics section). This pin should be tied to V_{IN} if the enable function is not used.

Foldback Current Limiting: Foldback current limiting is built into the LP38691/3 which reduces the amount of output current the part can deliver as the output voltage is reduced. The amount of load current is dependent on the differential voltage between V_{IN} and V_{OUT} . Typically, when this differential voltage exceeds 5V, the load current will limit at about 350 mA. When the $V_{\text{IN}} - V_{\text{OUT}}$ differential is reduced below 4V, load current is limited to about 850 mA.

SELECTING A CAPACITOR

It is important to note that capacitance tolerance and variation with temperature must be taken into consideration when selecting a capacitor so that the minimum required amount of capacitance is provided over the full operating temperature range.

Capacitor Characteristics

CERAMIC: For values of capacitance in the 10 to 100 μF range, ceramics are usually larger and more costly than tantalums but give superior AC performance for bypassing high frequency noise because of very low ESR (typically less than 10 m Ω). However, some dielectric types do not have good capacitance characteristics as a function of voltage and temperature.

Z5U and Y5V dielectric ceramics have capacitance that drops severely with applied voltage. A typical Z5U or Y5V capacitor can lose 60% of its rated capacitance with half of the rated voltage applied to it. The Z5U and Y5V also exhibit a severe temperature effect, losing more than 50% of nominal capacitance at high and low limits of the temperature range.

X7R and X5R dielectric ceramic capacitors are strongly recommended if ceramics are used, as they typically maintain a capacitance range within $\pm 20\%$ of nominal over full operating ratings of temperature and voltage. Of course, they are typically larger and more costly than Z5U/Y5U types for a given voltage and capacitance.

TANTALUM: Solid Tantalum capacitors have good temperature stability: a high quality Tantalum will typically show a capacitance value that varies less than 10-15% across the full temperature range of -40°C to $+125^{\circ}\text{C}$. ESR will vary only about 2X going from the high to low temperature limits.

PCB LAYOUT

Good PC layout practices must be used or instability can be induced because of ground loops and voltage drops. The input and output capacitors must be directly connected to the input, output, and ground pins of the regulator using traces which do not have other currents flowing in them (Kelvin connect).

The best way to do this is to lay out C_{IN} and C_{OUT} near the device with short traces to the V_{IN} , V_{OUT} , and ground pins. The regulator ground pin should be connected to the external circuit ground so that the regulator and its capacitors have a "single point ground".

It should be noted that stability problems have been seen in applications where "vias" to an internal ground plane were used at the ground points of the IC and the input and output capacitors. This was caused by varying ground potentials at these nodes resulting from current flowing through the ground plane. Using a single point ground technique for the regulator and its capacitors fixed the problem. Since high current flows through the traces going into V_{IN} and coming from V_{OUT} , Kelvin connect the capacitor leads to these pins so there is no voltage drop in series with the input and output capacitors.

RFI/EMI SUSCEPTIBILITY

RFI (radio frequency interference) and EMI (electromagnetic interference) can degrade any integrated circuit's performance because of the small dimensions of the geometries inside the device. In applications where circuit sources are present which generate signals with significant high frequency energy content ($> 1\text{ MHz}$), care must be taken to ensure that this does not affect the IC regulator.

If RFI/EMI noise is present on the input side of the regulator (such as applications where the input source comes from the output of a switching regulator), good ceramic bypass capacitors must be used at the input pin of the IC.

If a load is connected to the IC output which switches at high speed (such as a clock), the high-frequency current pulses required by the load must be supplied by the capacitors on the IC output. Since the bandwidth of the regulator loop is less than 100 kHz, the control circuitry cannot respond to load changes above that frequency. This means the effective output impedance of the IC at frequencies above 100 kHz is determined only by the output capacitor(s).

In applications where the load is switching at high speed, the output of the IC may need RF isolation from the load. It is recommended that some inductance be placed between the output capacitor and the load, and good RF bypass capacitors be placed directly across the load.

PCB layout is also critical in high noise environments, since RFI/EMI is easily radiated directly into PC traces. Noisy circuitry should be isolated from "clean" circuits where possible, and grounded through a separate path. At MHz frequencies, ground planes begin to look inductive and RFI/EMI can cause ground bounce across the ground plane. In multi-layer PCB applications, care should be taken in layout so that noisy power and ground planes do not radiate directly into adjacent layers which carry analog power and ground.

Application Hints (Continued)

OUTPUT NOISE

Noise is specified in two ways: **Spot Noise** or **Output Noise Density** is the RMS sum of all noise sources, measured at the regulator output, at a specific frequency (measured with a 1Hz bandwidth). This type of noise is usually plotted on a curve as a function of frequency. **Total Output Noise** or **Broad-Band Noise** is the RMS sum of spot noise over a specified bandwidth, usually several decades of frequencies.

Attention should be paid to the units of measurement. Spot noise is measured in units $\mu\text{V}/\text{root-Hz}$ or $\text{nV}/\text{root-Hz}$ and total output noise is measured in $\mu\text{V}(\text{rms})$

The primary source of noise in low-dropout regulators is the internal reference. Noise can be reduced in two ways: by increasing the transistor area or by increasing the current drawn by the internal reference. Increasing the area will decrease the chance of fitting the die into a smaller package. Increasing the current drawn by the internal reference increases the total supply current (ground pin current).

Physical Dimensions inches (millimeters) unless otherwise noted

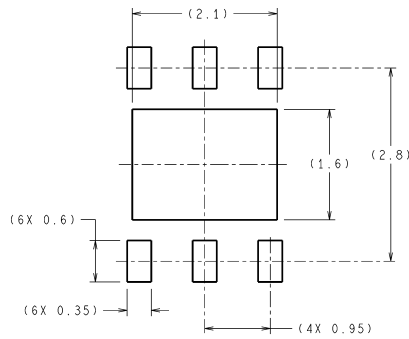

RECOMMENDED LAND PATTERN

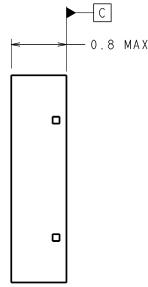
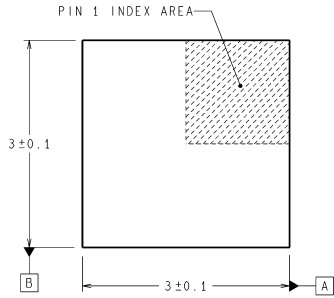

DIMENSIONS ARE IN MILLIMETERS
DIMENSION IN () FOR REFERENCE ONLY

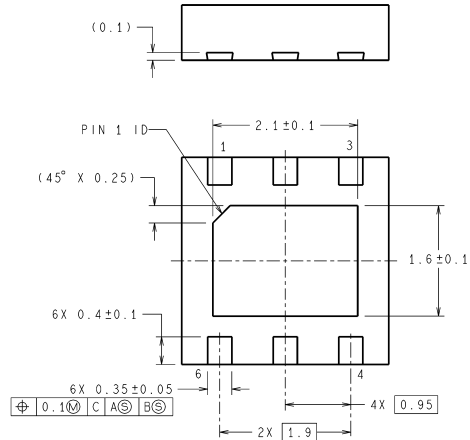

SDE06A (Rev A)

6-lead, LLP Package
NS Package Number SDE06A

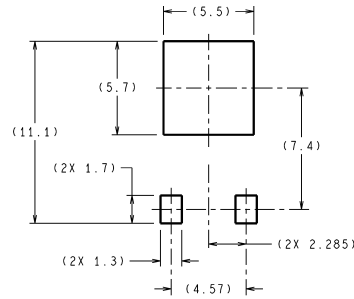

LAND PATTERN RECOMMENDATION

DIMENSIONS ARE IN MILLIMETERS

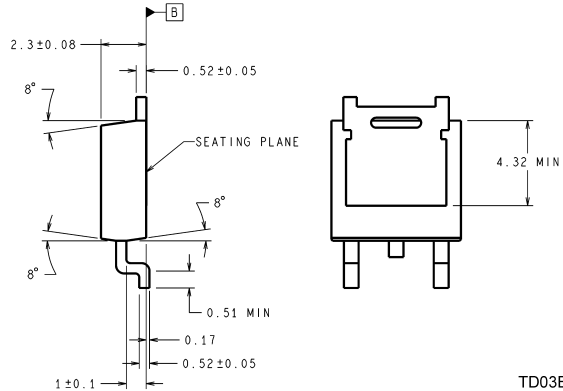
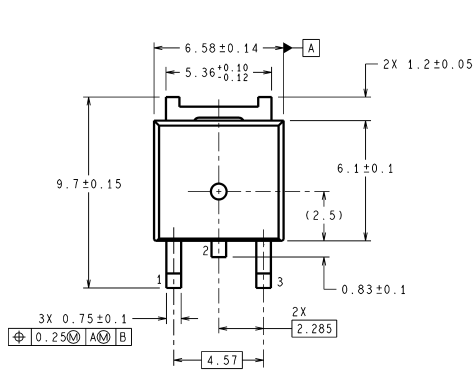

TD03B (Rev C)

TO-252 Package
NS Package Number TD03B

Physical Dimensions inches (millimeters) unless otherwise noted (Continued)

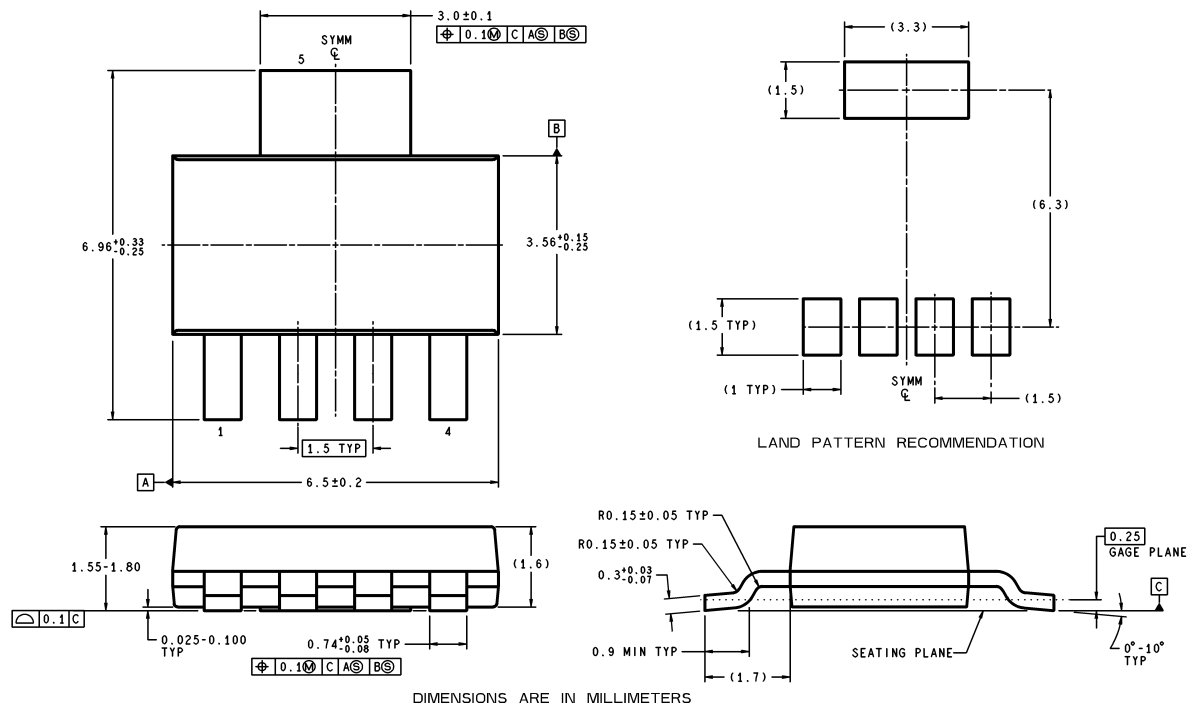

MP05A (Rev A)

SOT-223 Package
NS Package Number MP05A

National does not assume any responsibility for use of any circuitry described, no circuit patent licenses are implied and National reserves the right at any time without notice to change said circuitry and specifications.

For the most current product information visit us at www.national.com.

LIFE SUPPORT POLICY

NATIONAL'S PRODUCTS ARE NOT AUTHORIZED FOR USE AS CRITICAL COMPONENTS IN LIFE SUPPORT DEVICES OR SYSTEMS WITHOUT THE EXPRESS WRITTEN APPROVAL OF THE PRESIDENT AND GENERAL COUNSEL OF NATIONAL SEMICONDUCTOR CORPORATION. As used herein:

1. Life support devices or systems are devices or systems which, (a) are intended for surgical implant into the body, or (b) support or sustain life, and whose failure to perform when properly used in accordance with instructions for use provided in the labeling, can be reasonably expected to result in a significant injury to the user.
2. A critical component is any component of a life support device or system whose failure to perform can be reasonably expected to cause the failure of the life support device or system, or to affect its safety or effectiveness.

BANNED SUBSTANCE COMPLIANCE

National Semiconductor certifies that the products and packing materials meet the provisions of the Customer Products Stewardship Specification (CSP-9-111C2) and the Banned Substances and Materials of Interest Specification (CSP-9-111S2) and contain no "Banned Substances" as defined in CSP-9-111S2.



National Semiconductor
Americas Customer
Support Center
Email: new.feedback@nsc.com
Tel: 1-800-272-9959

National Semiconductor
Europe Customer Support Center
Fax: +49 (0) 180-530 85 86
Email: europa.support@nsc.com
Deutsch Tel: +49 (0) 69 9508 6208
English Tel: +44 (0) 870 24 0 2171
Français Tel: +33 (0) 1 41 91 8790

National Semiconductor
Asia Pacific Customer
Support Center
Email: ap.support@nsc.com

National Semiconductor
Japan Customer Support Center
Fax: 81-3-5639-7507
Email: jpn.feedback@nsc.com
Tel: 81-3-5639-7560

www.national.com