

Micro-Power Voltage Detectors, Reset Of MCU With Delay Time

General Description

The LP3809 is a micro-power voltage detector supervising the power supply voltage level for microprocessors (μP) or digital systems. It provides internally fixed threshold levels with 0.1V per step ranging from 1.2V to 5V, which covers most digital applications. It features low supply current of $3\mu\text{A}$. The LP3809 performs supervisory function by sending out a reset signal whenever the VDD voltage falls below a preset threshold level. This reset signal will last the whole period before VDD recovering. Once VDD recovered upcrossing the threshold level, the reset signal will be released after a certain delay time. Available in the 5-lead of SOT-23 packages.

Pin Configurations

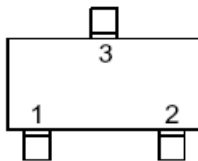

SOT-23

Pin No.	1	2	3
Type A	RESET	GND	VDD
Type B	GND	RESET	VDD

Typical Application Circuit

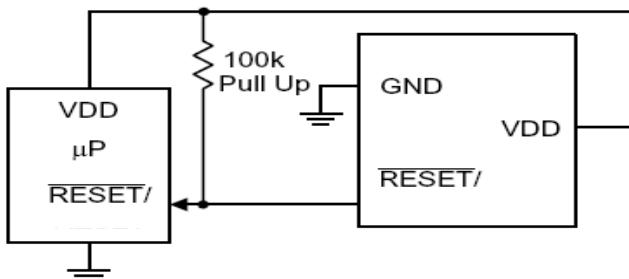

Features

- ◆ Built-in Recovery Delay Include 210ms
- ◆ Internally Fixed Threshold 1.2V to 5V in 0.1V Step
- ◆ No External Components Required
- ◆ High Accuracy $\pm 1.5\%$
- ◆ Low Supply Current $3\mu\text{A}$
- ◆ Low Functional Supply Voltage 0.9V
- ◆ N-Channel Open-Drain output
- ◆ Quick Start-Up

Applications

- ✧ Computers
- ✧ CPU/MCU/DSP
- ✧ Portable
- ✧ Battery-Powered Equipment

Ordering Information

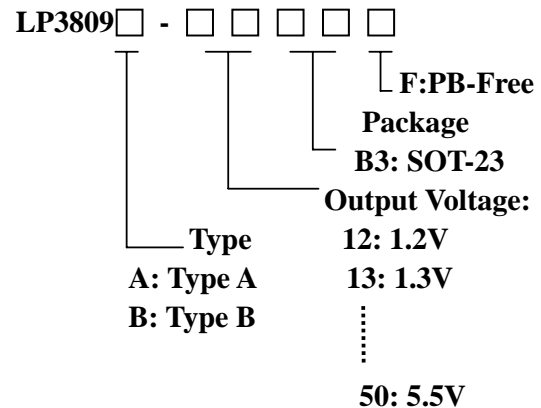

Note:

1. Output Voltage range from 1.2V to 5.0V in 0.1V increments.
2. 2.7V output order is LP3809A-27B3F.

Functional Pin Description

Pin Name	Pin Function
GND	Ground
RESET	Active Low Open-Drain Reset Output
VDD	Power Pin

Function Block Diagram

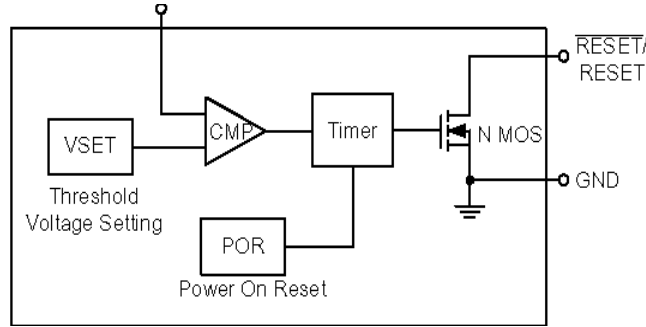

Absolute Maximum Ratings

Supply Input Voltage	-----6V
Power Dissipation, PD @ TA = 25°C	
SOT-23	-----400mW
Package Thermal Resistance	
SOT-23, θ_{JA}	-----250°C/W
ESD Susceptibility	
HBM (Human Body Mode)	-----2kV
MM(Machine-Mode)	-----200V
Recommended Operating Conditions	
Supply Input Voltage	-----0.3V to 6V
Operation Ambient Temperature Range	-----40°C to 85°C

Electrical Characteristics

Parameter	Symbol	Test Conditions	Min	Typ	Max	Units
Quiescent Current	I _Q	V _{EN} ≥ 1.2V, I _{OUT} = 0mA		3		μ A
Reset Threshold	V _{TH}	T _A = 27°C	1.2		1.5	V
Threshold Voltage Accuracy	Δ V _{TH}		-1.5		1.5	%
VDD Drop to Reset Delay	Trd	Drop = V _{TH} -125mV		20		uS
Reset Active Time	LP3809A/B	V _{DD} ≥ 1.02×V _{TH}		210		mS
RESET Output Voltage Low	V _{OL}	3 = V _{DD} < V _{TH} I _{SINK} >3.5mA		0.4		V
Thermal Shutdown Temperature	T _{SD}			165		° C

Typical Operating Characteristics

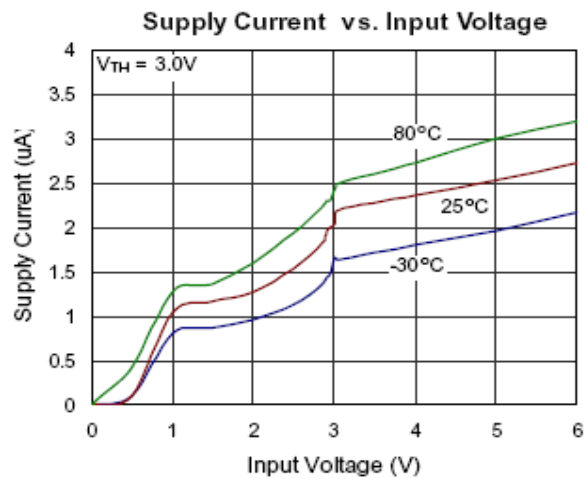
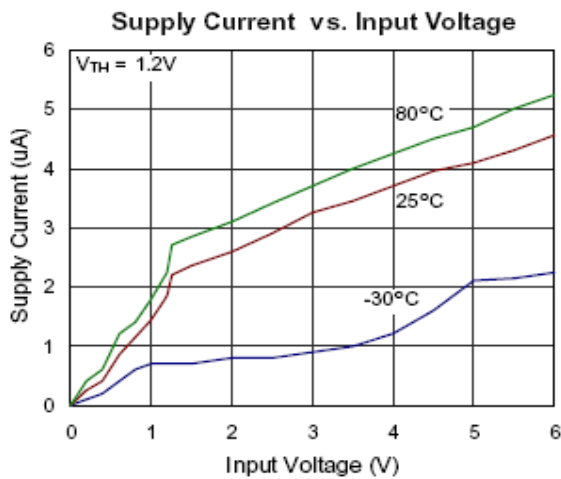
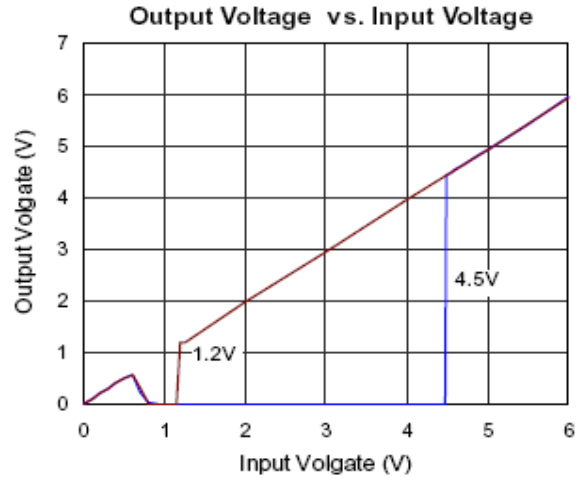
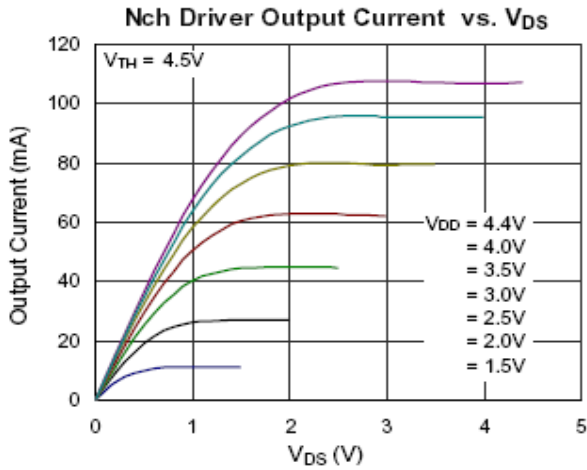
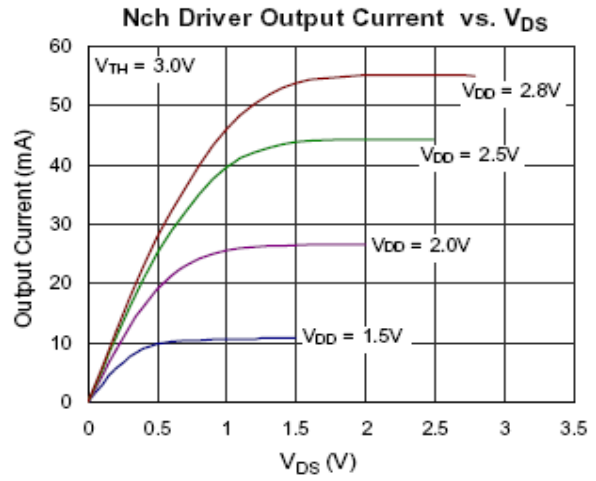
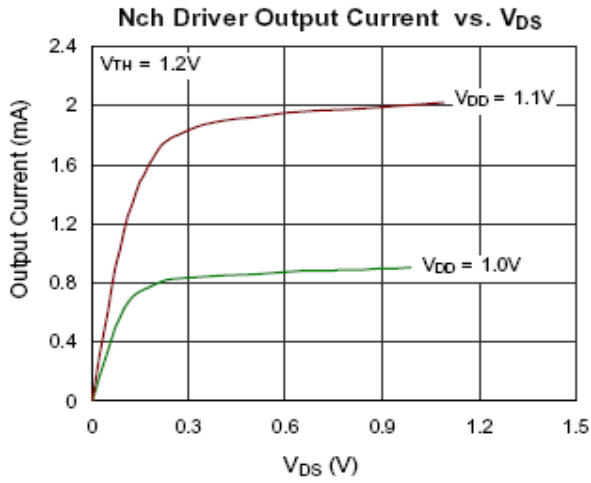

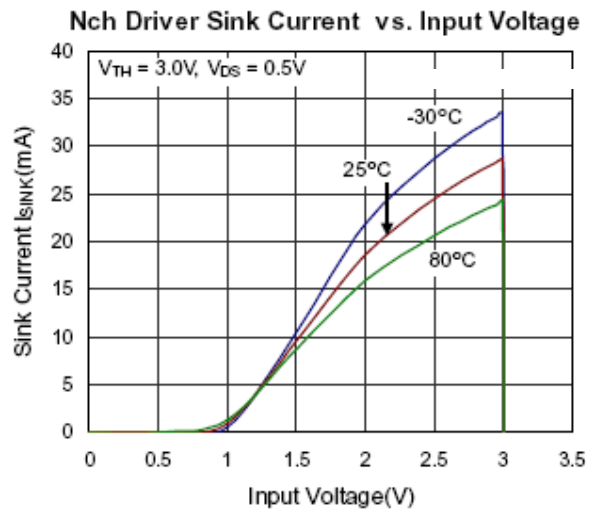
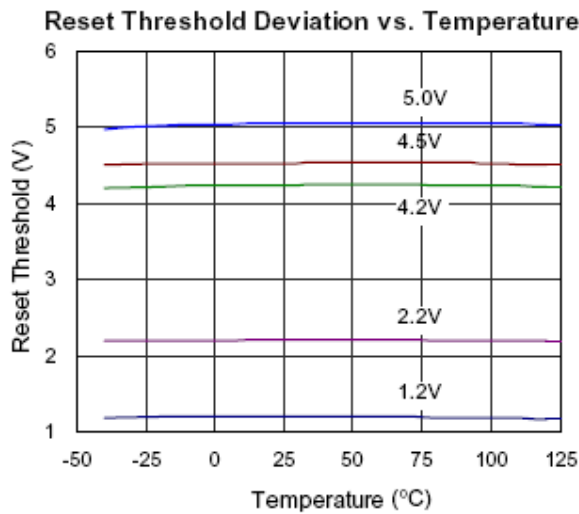
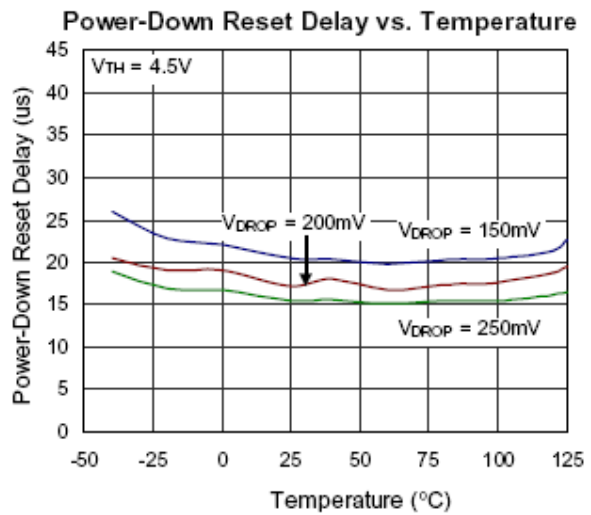
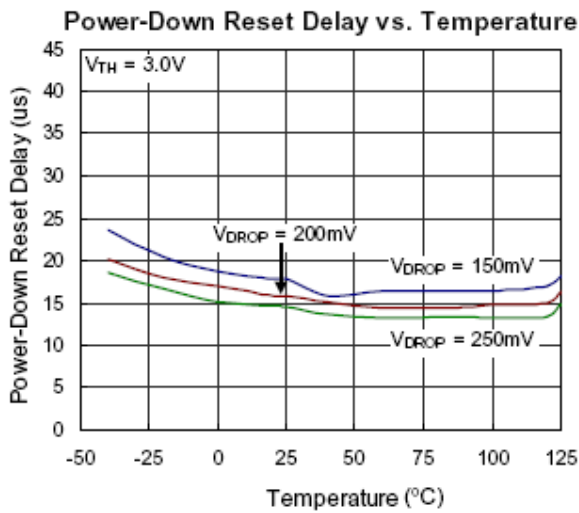
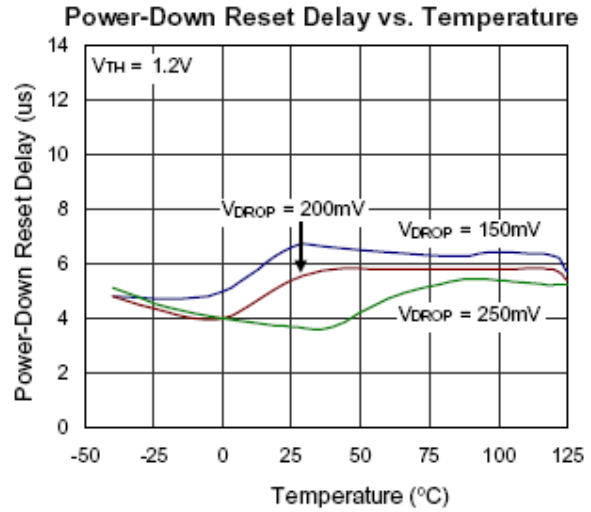
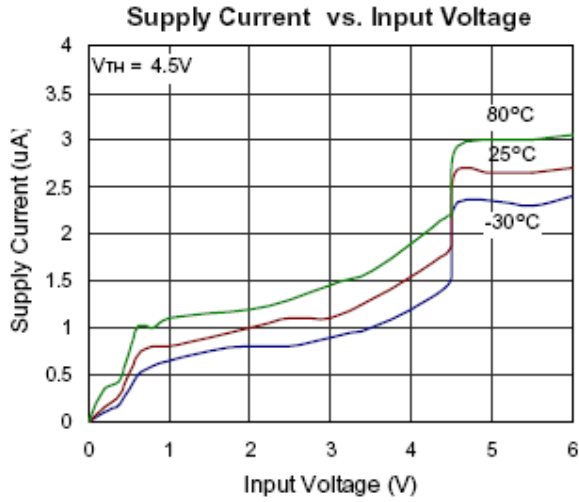

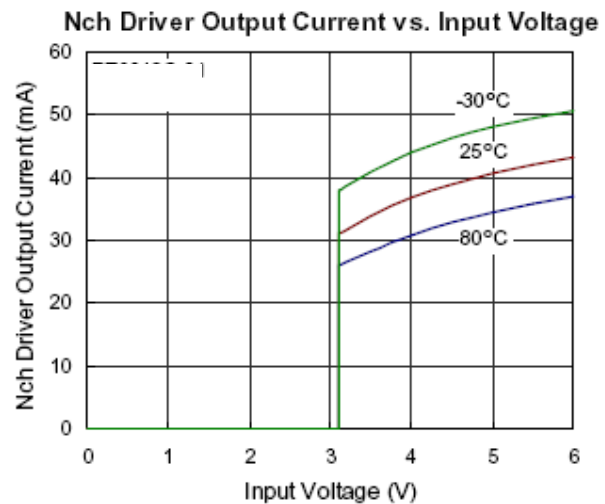
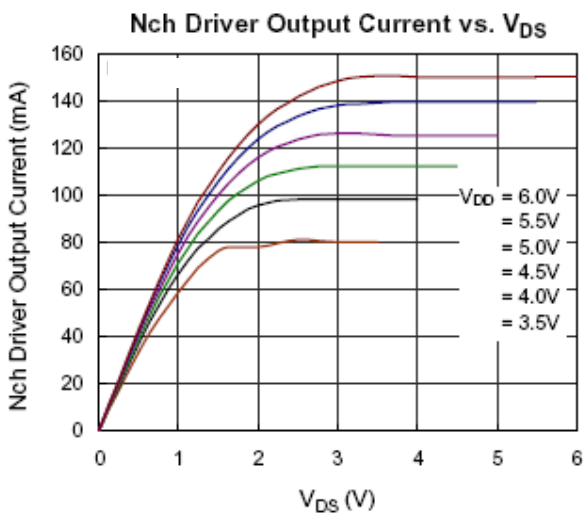
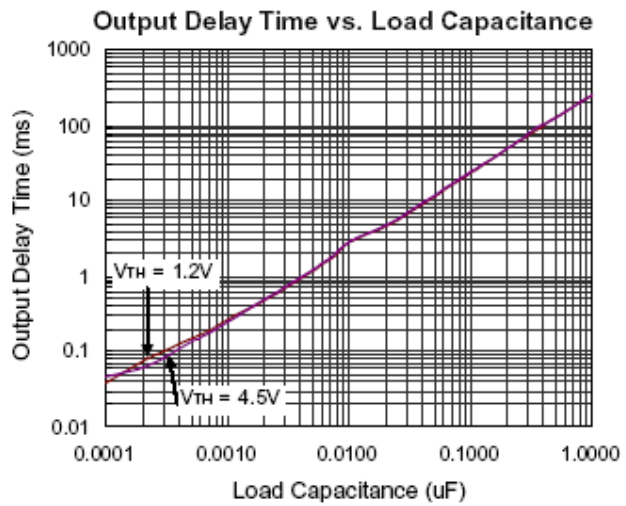
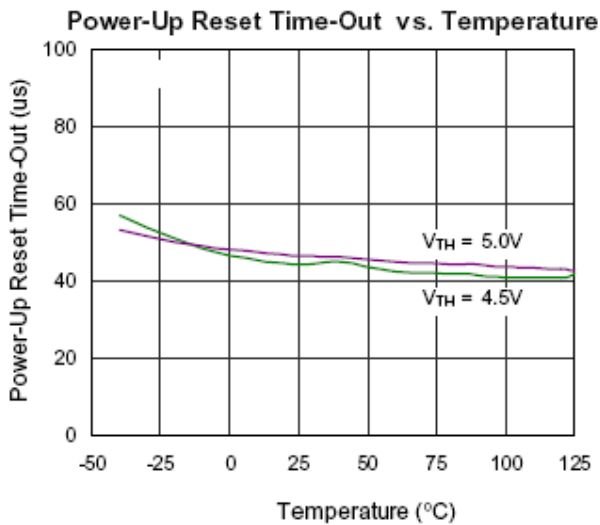
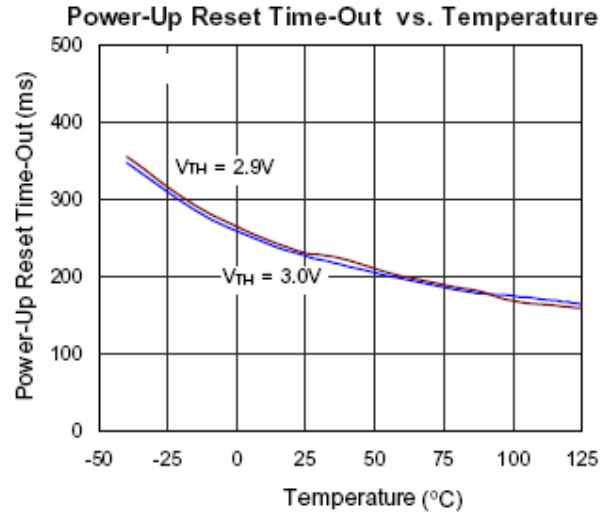
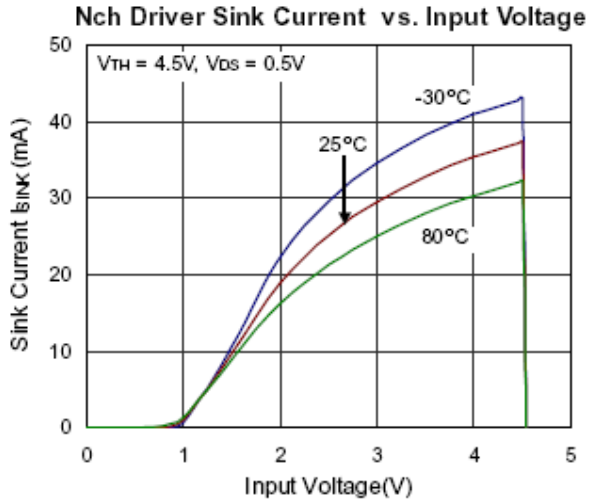

Package Information

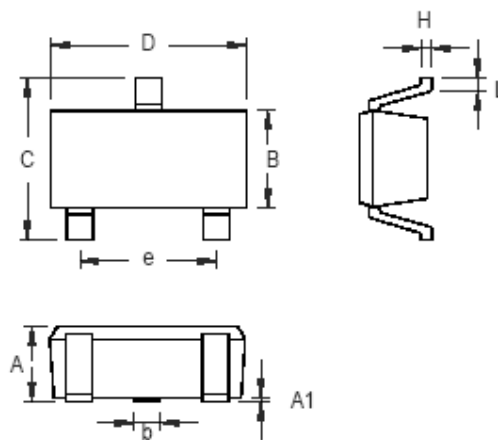

Symbol	Dimensions In Millimeters		Dimensions In Inches	
	Min	Max	Min	Max
A	0.889	1.295	0.035	0.051
A1	0.000	0.152	0.000	0.006
B	1.397	1.803	0.055	0.071
b	0.356	0.508	0.014	0.020
C	2.591	2.997	0.102	0.118
D	2.692	3.099	0.106	0.122
e	1.803	2.007	0.071	0.079
H	0.080	0.254	0.003	0.010
L	0.300	0.610	0.012	0.024

SOT-23-3 Surface Mount Package