

Series A5000 & Series CB5000

Single Row Terminal Blocks

SPECIFICATIONS

Rating: 10A, 300V*

Center Spacing: .250" (6.35 mm)

Wire Range: #16-30 AWG CU

Screw Size: #3-48 zinc plated phillslot SEMS screws, wire-ready standard

Torque Rating: 4 in-lbs.

Distance Between Barriers: .20" (5.08 mm)

Recommended PCB Hole Diameter: .062" (1.57 mm)

Operating Temperature: 105°C (221°F) max., -40°C (-40°F) min.

Molded Material: Black, UL Rated 94V0 Thermoplastic

Breakdown Voltage: 1600V rms

Agency Information: UL/CSA; CE Certified

* Max. rating shown; some options may be rated lower – consult factory.



Poles	MOUNTING ENDS		BARRIER ENDS	
	A Mount Centers	B Overall Length	A Pole Centers	B Overall Length
02	.75	1.06	.25	.56
03	1.00	1.31	.50	.81
04	1.25	1.56	.75	1.06
05	1.50	1.81	1.00	1.31
06	1.75	2.06	1.25	1.56
07	2.00	2.31	1.50	1.81
08	2.25	2.56	1.75	2.06
09	2.50	2.81	2.00	2.31
10	2.75	3.06	2.25	2.56
11	3.00	3.31	2.50	2.81
12	3.25	3.56	2.75	3.06
13	3.50	3.81	3.00	3.31
14	3.75	4.06	3.25	3.56
15	4.00	4.31	3.50	3.81
16	4.25	4.56	3.75	4.06
17	4.50	4.81	4.00	4.31
18	4.75	5.06	4.25	4.56
19	5.00	5.31	4.50	4.81
20	5.25	5.56	4.75	5.06
21	5.50	5.81	5.00	5.31
22	5.75	6.06	5.25	5.56
23	6.00	6.31	5.50	5.81
24	6.25	6.56	5.75	6.06
25	6.50	6.81	6.00	6.31
26	6.75	7.06	6.25	6.56
27	7.00	7.31	6.50	6.81
28	7.25	7.56	6.75	7.06
29			7.00	7.31
30			7.25	7.56

* Dimensions in inches. To convert to millimeters, multiply by 25.4.

A5000 Series

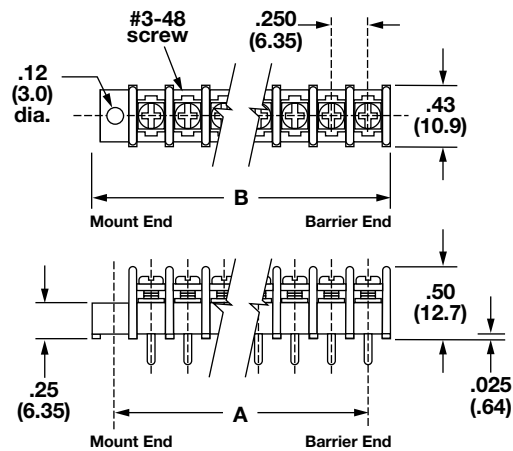

CB5000 Series

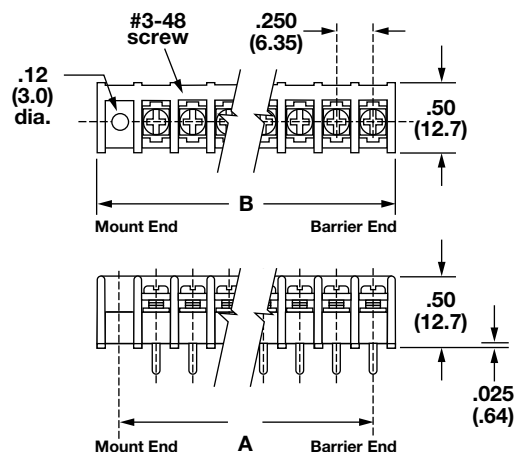

Part Numbering System

Series	Terminal Style	Base/End	Poles	Screw Options	Options
A5					
CB5					
A5 - standard barrier CB5 - closed barrier	01 - handwired 02 - printed circuit 03 - non feed-thru 04 - wire wrap tail	1 - mount end 2 - barrier end	02 to 30 02 to 28 on mount end base	07 - steel SEMS std. wire ready	C1 to C8 - .110" QC L1 to L6 marking options (pg 22) LT1 to LT6 marking options (CB5 only-pg 22) OJ - over barrier jumper S1 - single solder lug/flat S2 - double solder lug/flat (A5 only)

Terminal Styles

Inches (Millimeters)

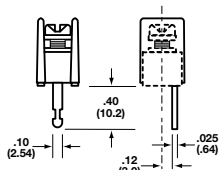

01
Handwired

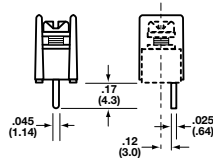

02
Circuit Board



03
Non Feed-Thru

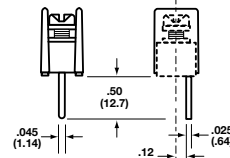

04
Wire Wrap Tail

CB5 Terminal Exit Options

Inches (Millimeters)

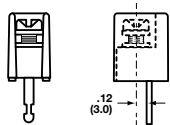

Exit Rear (std.)

Screw Options Wire ready screws standard on all terminal styles



07
Steel SEMS
Zinc Plated



07
Standard
Wire Ready

Hardware Options (Bulk ordering part numbers are in parentheses.)

Jumpers



OJ12

Quick Connects Blade Width .110" (For other orientations, contact factory.)

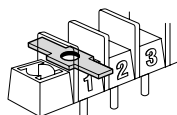

C1 (5C1) *

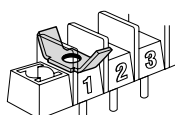

C2 (5C2) *

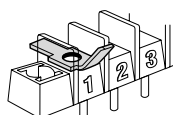

C4 (5C4) *

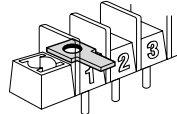

C7 (5C7)

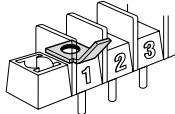

C8 (5C8)

* N/A on CB5 Series.

Solder Lugs

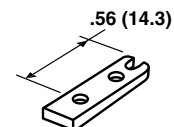

S1 (5S1)

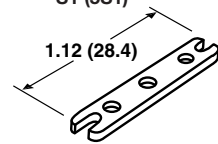

S2 (5S2)

Series A1000 & Series CB1000

Single Row Terminal Blocks

SPECIFICATIONS

Rating: 20A, 150V

Center Spacing: .325" (8.26 mm)

Wire Range: #14-22 AWG CU

Screw Size: #6-32 zinc plated phillslot wire-ready screws with a #2 driving recess.

Torque Rating: 9 in-lb.

Base: Standoffs are standard on CB1000 Series for easy flux washing.

Distance Between Barriers: .26" (6.6 mm)

Recommended PCB Hole Diameter: .070" (1.78 mm)

Operating Temperature: 105°C (221°F) max., -40°C (-40°F) min.

Molded Material: Black, UL Rated 94V0 Thermoplastic

Breakdown Voltage: 1600V

Agency Information: UL/CSA; IEC Compliance; CE Certified



CB10210707

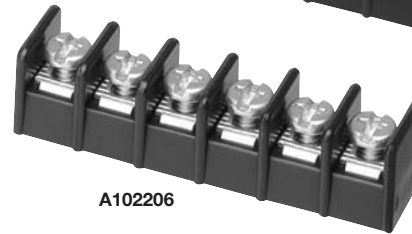

A102206

Poles	MOUNTING ENDS ONLY		BARRIER & MOUNTING ENDS B Pole Ctrs.	BARRIER ENDS ONLY C Length
	A Mount Ctrs.	C Length		
02	.98	1.37	.33	.72
03	1.30	1.69	.65	1.04
04	1.63	2.02	.98	1.37
05	1.95	2.34	1.30	1.69
06	2.28	2.67	1.63	2.02
07	2.60	2.99	1.95	2.34
08	2.93	3.32	2.28	2.67
09	3.25	3.64	2.60	2.99
10	3.58	3.97	2.93	3.32
11	3.90	4.29	3.25	3.64
12	4.23	4.62	3.58	3.97
13	4.55	4.94	3.90	4.29
14	4.88	5.27	4.23	4.62
15	5.20	5.59	4.55	4.94
16	5.53	5.92	4.88	5.27
17	5.85	6.24	5.20	5.59
18	6.18	6.57	5.53	5.92
19	6.50	6.89	5.85	6.24
20	6.83	7.22	6.18	6.57
21	7.15	7.54	6.50	6.89
22	7.48	7.87	6.83	7.22
23	7.80	8.19	7.15	7.54
24	8.13	8.52	7.48	7.87
25	8.45	8.84	7.80	8.19
26	8.78	9.17	8.13	8.52
27	9.10	9.49	8.45	8.84
28	9.43	9.82	8.78	9.17
29	9.75	10.14	9.10	9.49
30	10.08	10.47	9.43	9.82
31	10.40	10.79	9.75	10.14
32	10.73	11.12	10.08	10.47
33	11.05	11.44	10.40	10.79
34	11.38	11.77	10.73	11.12
35			11.05	11.44
36			11.38	11.77

A1000 Series

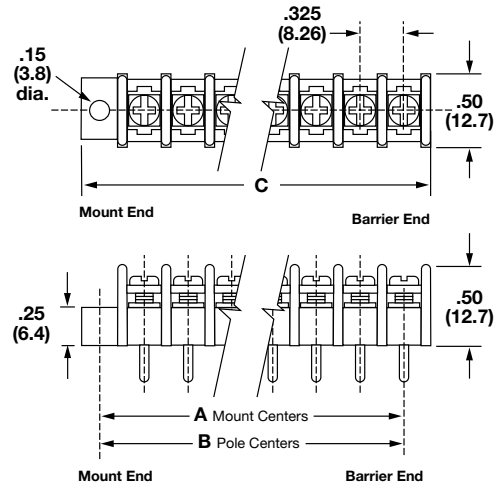

CB1000 Series

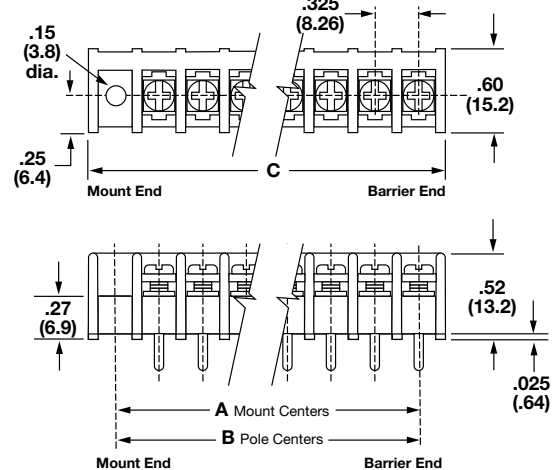

* Dimensions in inches. To convert to millimeters, multiply by 25.4.

Part Numbering System

Series	Terminal Style	Base/End	Poles	Screw Options	Options
A1					
CB1					
A1 - standard barrier CB1 - closed barrier	02 - printed circuit 03 - non feed-thru 04 - wire wrap tail 07 - extended pin	1 - mount end 2 - barrier end		Blank - std. screws 03 - stainless steel 04 - nickel brass 07 - steel SEMS & washer (not available with hardware options) CA - standard captive screw 07CA - SEMS captive	AB & DR - angle mts. (A1 only-pg 5) B1 to B9 - .187" QC (all positions) EB - exit back terminals on CB1 w/07 screw option only JA, JB & JC - barrier jumpers L1 to L6 marking options (pg 22) LT1 to LT6 marking options (CB1 only-pg 22) MP & MT - mounting plates (pg 5) R26 & R45 - right angle bends (A1 only-pg 5)

Covers - (pg 23)

Terminal Styles

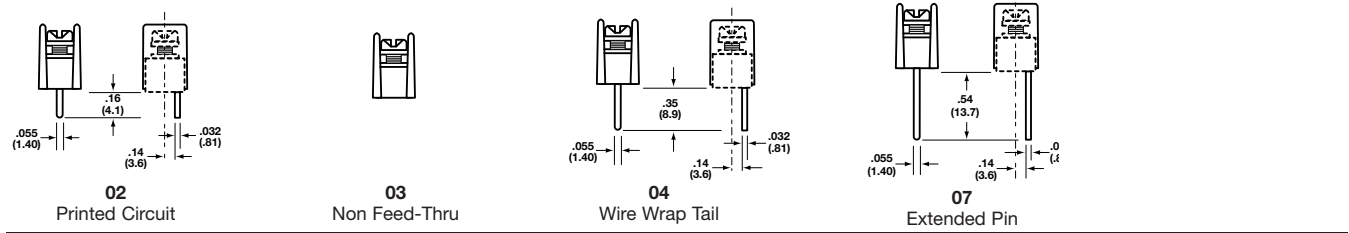

Screw Options

Wire ready screws standard on all terminal styles

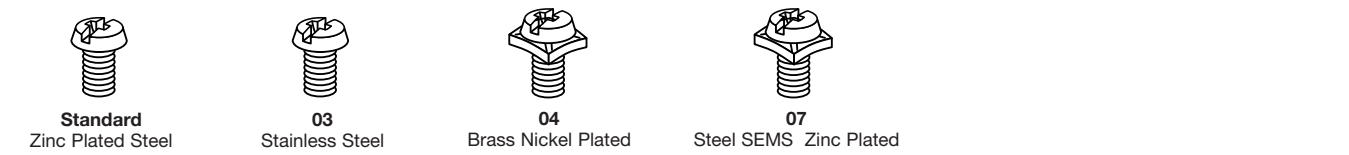

CB1 Terminal Exit Options



Hardware Options

(Bulk ordering part numbers are in parentheses.)

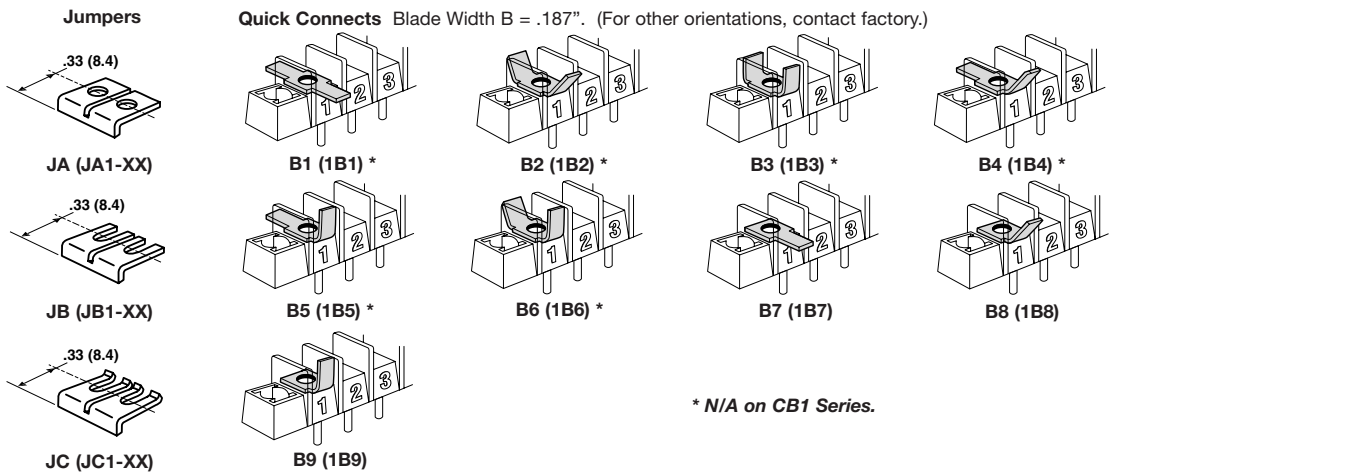

Series A1000 & CB1000

Single Row Terminal Blocks

Mounting Options

Inches (Millimeters)

Right Angle Bends (A1 only)

Right angle terminals are offered on the A1000 Series. Configurations are defined in these dimensions: X = pin extension beyond the block base; Z = length from block base to centerline of the terminal tip. Standard bends consist of the X and Z dimensions shown in the chart. Specify by adding the selected Bend Option Code to the terminal part no.

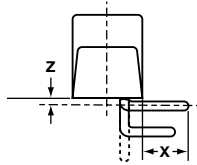

Bend Option Code	X (minimum)	Z
R26 (04 terminal only)	.14	.09
R45 (07 terminal only)	.33	.09

Dimensions in inches. To convert to millimeters, multiply by 25.4.

Angle Brackets (A1 only)

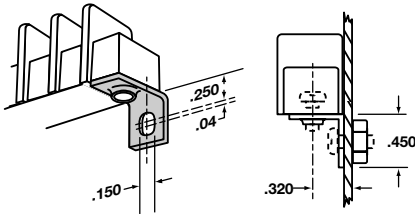

Option AB

Angle brackets enable block to be fastened at right angles to normal mount position. Bulk part no. **1AB**.

Drilled Right Angle (A1 only)

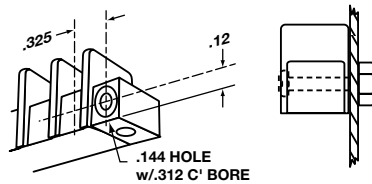

Option DR

Counterbored holes across mount ends of block enable fastening with two screws at right angles to normal mount position.

Mounting Plates

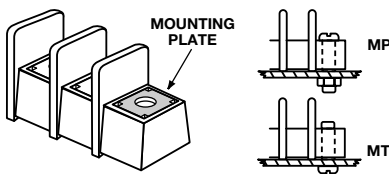

Options MP & MT

MP Metal inserts with .150" dia. hole accept #6 screw. **MT** Metal inserts with tapped hole accept #6-32 screw. Bulk Part Nos. **1MP & 1MT**.

Series A2000, LP2000 & CB2000

Single Row Terminal Blocks

SPECIFICATIONS

Rating: A2: 30A, 300V*

LP2: 30A, 150V*

CB2: 30A, 300V*

Center Spacing: .375" or 3/8" (9.52 mm)

Wire Range: #12-22 AWG CU

Screw Size: #6-32 zinc plated phillslot

Torque Rating: 9 in-lb.

Base: Standoffs standard for easy flux washing

Distance Between Barriers: .32" (8.1 mm)

Recommended PCB Hole Diameter: .076" (1.93 mm)

Operating Temperature: 105°C (221°F) max., -40°C (-40°F) min.

Molded Material: Black, UL Rated 94V0 Thermoplastic

Breakdown Voltage: 3400V (A2 & LP2); 4100V (CB2).

Agency Information: UL/CSA; IEC Compliance;

CE Certified

*30A Rating achieved with a #10 copper wire crimped to a ring terminal.;
20A Rating without ring terminal.

A20510807WR



LP202110



CB20210507

A2000 & LP2000 Series

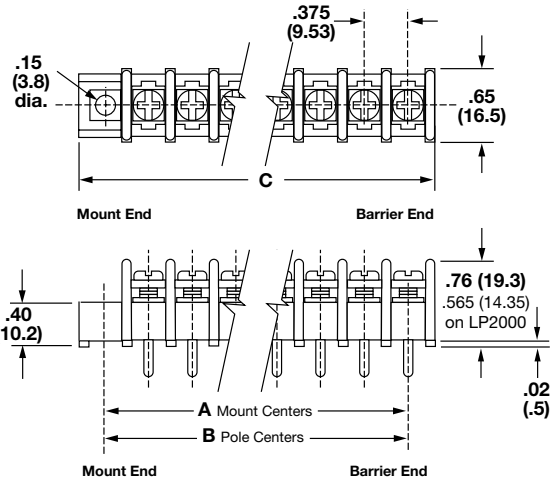

CB2000 Series

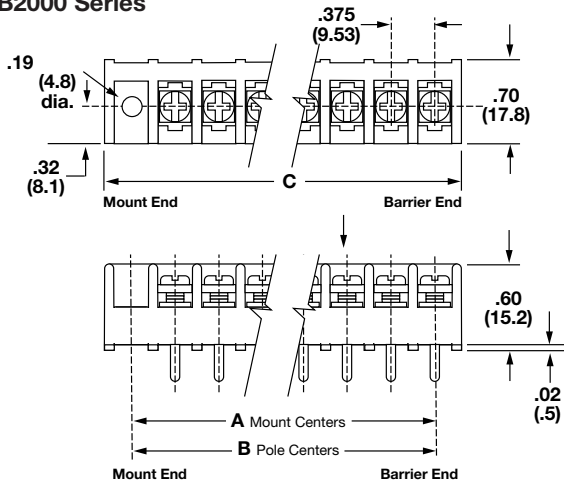

Poles	MOUNTING ENDS ONLY		BARRIER & MOUNTING ENDS B Pole Ctrs.	BARRIER ENDS ONLY C Length
	A Mount Ctrs.	C Length		
02	1.13	1.56	.38	.81
03	1.50	1.93	.75	1.18
04	1.88	2.30	1.13	1.56
05	2.25	2.68	1.50	1.93
06	2.63	3.06	1.88	2.31
07	3.00	3.43	2.25	2.68
08	3.38	3.81	2.63	3.06
09	3.75	4.18	3.00	3.43
10	4.13	4.56	3.38	3.81
11	4.50	4.93	3.75	4.18
12	4.88	5.31	4.13	4.56
13	5.25	5.69	4.50	4.93
14	5.63	6.06	4.88	5.31
15	6.00	6.43	5.25	5.68
16	6.38	6.81	5.63	6.06
17	6.75	7.18	6.00	6.43
18	7.13	7.56	6.38	6.81
19	7.50	7.93	6.75	7.18
20	7.88	8.31	7.13	7.56
21	8.25	8.68	7.50	7.93
22	8.63	9.06	7.88	8.31
23	9.00	9.43	8.25	8.68
24	9.38	9.81	8.63	9.06
25	9.75	10.18	9.00	9.43
26	10.13	10.56	9.38	9.81
27	10.50	10.93	9.75	10.18
28	10.88	11.31	10.13	10.55
29	11.25	11.68	10.50	10.93
30	11.63	12.05	10.88	11.31
31			11.25	11.68
32			11.63	12.05

* Dimensions in inches. To convert to millimeters, multiply by 25.4.

Series A2000 & LP2000

Single Row Terminal Blocks

Part Numbering System

Series	Terminal Style	Base/End	Poles	Screw Options	Options
A 2	<input type="checkbox"/> <input type="checkbox"/>	<input type="checkbox"/>	<input type="checkbox"/> <input type="checkbox"/>	<input type="checkbox"/> <input type="checkbox"/> <input type="checkbox"/> <input type="checkbox"/>	<input type="checkbox"/> <input type="checkbox"/> <input type="checkbox"/>
LP 2	<input type="checkbox"/> <input type="checkbox"/>	<input type="checkbox"/>	<input type="checkbox"/> <input type="checkbox"/>	<input type="checkbox"/> <input type="checkbox"/> <input type="checkbox"/> <input type="checkbox"/>	<input type="checkbox"/> <input type="checkbox"/> <input type="checkbox"/>
A2 - standard barrier LP2 - low profile barrier	01 - handwired 02 - printed circuit 03 - non feed-thru 04 - wire wrap tail 05 - extended handwired 06 - handwired 07 - extended pin 08 - printed circuit 09 - .250 QC short 10 - .187 QC 14 - printed circuit 19 - .250 QC long	0 - flat base/molded mount end 1 - flat base/mnt. end 2 - flat base/barrier end 3 - insulator base/mnt. end 4 - insulator base/barrier end 5 - closed base/mount end 6 - closed base/molded mount end 9 - insulator base/molded mount end Base/End Note: 0, 6, 9 styles not available with covers. 5 & 6 Styles only available with 03 terminals.	02 to 32 02 to 30 on mount end base	Blank - std. screw 00 - screws shipped bulk 03 - stainless steel 04 - brass nickel plated 07 - steel SEMS (not available with hardware options) 09 - brass SEMS nickel plated (not available with hardware options) CA - captive screw 03CA - stainless steel captive 04CA - brass captive 07CA - SEMS captive 09CA - brass SEMS captive 07WR - steel SEMS wire ready (not available on LP2)	AB - angle mnt. options (pg 9) A1 to A9 - .250" QC B1 to B9 - .187" QC DR - drilled right angle (pg 9) JA, JB & JC - barrier jumpers L1 to L6 marking options (pg 22) MP, MP8 & MT mounting plates (pg 9) OJ2 & OJ4 - over barrier jumpers (not available w/covers) RC - retaining clips (pg 9) R30 to R77 - right angle bends (pg 9) SO - stand off insulators (pg 9) S1 - solder lug/flat Covers - (pg 23)

Terminal Styles

Inches (Millimeters)

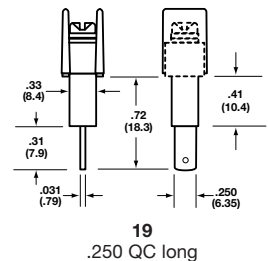
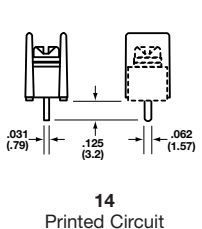
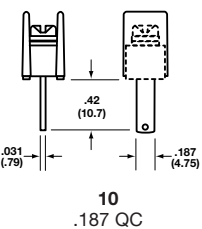
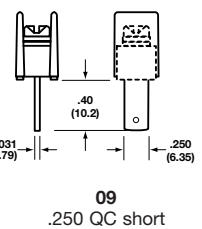
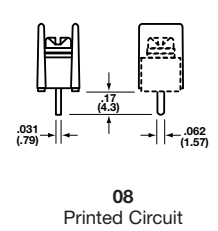
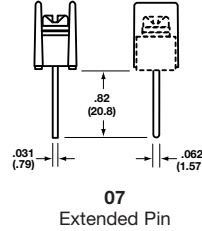
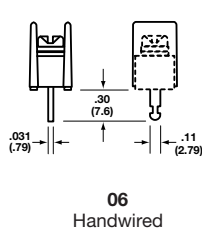
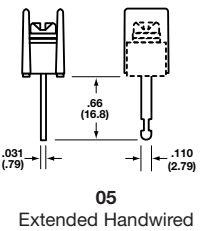
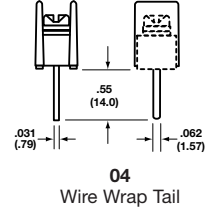
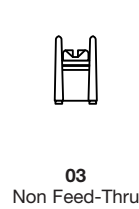
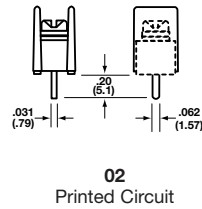
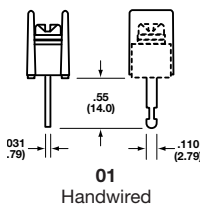

Series A2000 & LP2000

Single Row Terminal Blocks *Continued*

Screw Options



Standard
Zinc Plated Steel



03
Stainless Steel



04
Brass
Nickel Plated



07
Steel SEMS



09
Brass SEMS
Nickel Plated



07WR
Wire Ready
(A2 only)

Hardware Options (Bulk ordering part numbers are in parentheses.)

Inches (Millimeters)

Solder Lugs

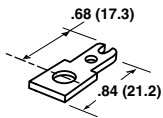

S1
(2S1)

Jumpers

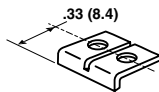

JA
(JA2-XX)

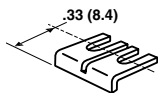

JB
(JB2-XX)

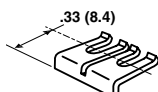

JC
(JC2-XX)



OJ2



OJ4

Quick Connects

Blade Width A = .250" Blade Width B = .187"

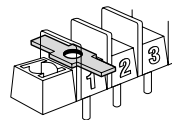

A1 & B1
(2A1 & 2B1)

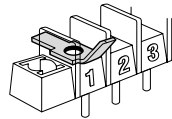

A4 & B4
(2A4 & 2B4)

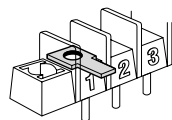

A7 & B7
(2A7 & 2B7)

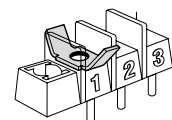

A2 & B2
(2A2 & 2B2)

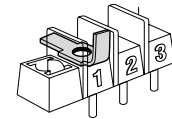

A5 & B5
(2A5 & 2B5)

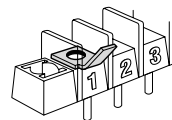

A8 & B8
(2A8 & 2B8)

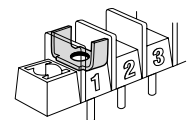

A3 & B3
(2A3 & 2B3)

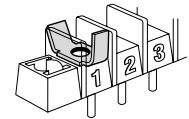

A6 & B6
(2A6 & 2B6)

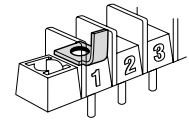

A9 & B9
(2A9 & 2B9)

Base/End Options

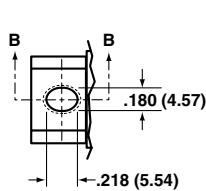

SECTION A-A

0, 6 & 9
Molded Mount End

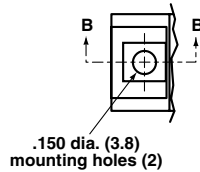

SECTION B-B

1, 3 & 5
Mount End

Series A2000 & LP2000

Single Row Terminal Blocks *Continued*

Mounting Options

Right Angle Bends (A2, LP2 only)

Right angle terminals are offered on the A2000 & LP2000 Series. Configurations are defined in these dimension: X = pin extension beyond the block base; Z = length from block base to centerline of the terminal tip. Standard bends consist of the X and Z dimensions shown in the chart. Specify by adding the selected Bend Option Code to the terminal part no.

04 Terminal Bend Configurations

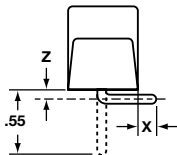

Bend Option Code	X (minimum)	Z	Available w/insulator base
R30	-.04	.28	No
R35	.01	.23	No
R36	.02	.22	No
R39	.05	.19	No
R42	.08	.16	No
R46	.12	.12	No
R48	.14	.10	No
R50	.16	.08	No

07 Terminal Bend Configurations

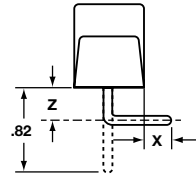

Bend Option Code	X (minimum)	Z	Available w/insulator base
R30	-.04	.55	Yes
R35	.01	.50	Yes
R36	.02	.49	Yes
R42	.08	.43	Yes
R46	.12	.39	Yes
R50	.16	.35	No
R53	.19	.32	No
R66	.32	.19	No
R69	.35	.16	No
R75	.41	.10	No
R77	.43	.08	No

Dimensions in inches. To convert to millimeters, multiply by 25.4.

Angle Brackets (A2, LP2 only)

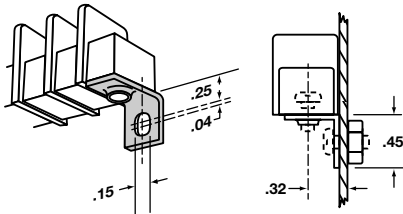

Option AB

Angle brackets enable block to be fastened at right angles to normal mount position. Bulk part no. **2AB**.

Drilled Right Angle (A2, LP2 only)

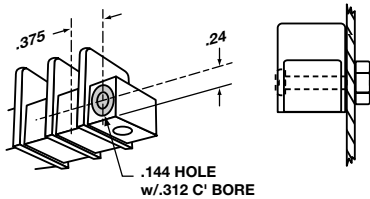

Option DR

Counterbored holes across mount ends of block enable fastening with two screws at right angles to normal mount position.

Mounting Plates

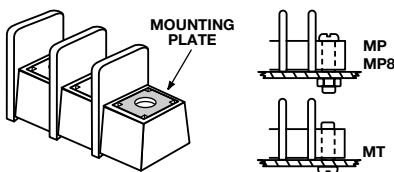

Options MP, MP8 & MT

MP Metal inserts with .150" dia. hole accept #6 screw. **MP8** Metal inserts with .187" dia. hole accept #8-32 screw. **MT** Metal inserts with tapped hole accept #6-32 screw.

Standoffs

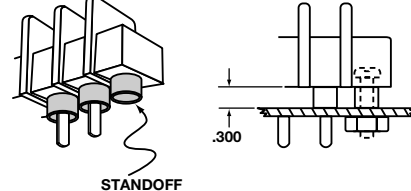

Option SO

Standoff mounts are tubes molded to the mounting positions. Available with insulator bases only.

Retaining Clip

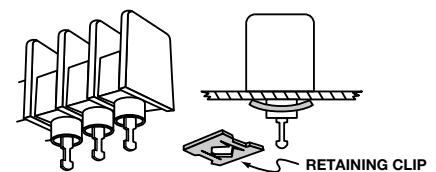

Option RC

Use on standoff tubes. Fit panels up to .125" thick. Two clips for every five positions. Supplied unassembled. Bulk Part No. **H541**.

Series CB2000

Single Row Terminal Blocks

Part Numbering System

Series	Terminal Style	Base/End	Poles	Screws	Options
C B 2					
CB2 - closed back	01 - handwired 02 - printed circuit 03 - non feed-thru 07 - extended pin 14 - printed circuit 22 - dual tail printed circuit	1 - mount end 2 - barrier end	02 to 32 02 to 30 on mount end base	03 - stainless steel 04 - brass nickel plated 07 - steel SEMS standard 09 - brass SEMS nickel plated CA - captive screw 07CA - SEMS captive	AB - angle mounting brackets (pg 11) A7 to A9 - .250" QC B7 to B9 - .187" QC EB - exit back terminals EF - exit front terminals JA, JB & JC - barrier jumpers L1 to L6 marking options (pg 22) LT1 to LT6 marking options (pg 22) OJ2 & OJ4 - over barrier jumpers MP, MP8, MT & MT8 mtg. plates (pg 11) S1 - solder lug/flat Covers - (pg.23)

Terminal Styles

Inches (Millimeters)

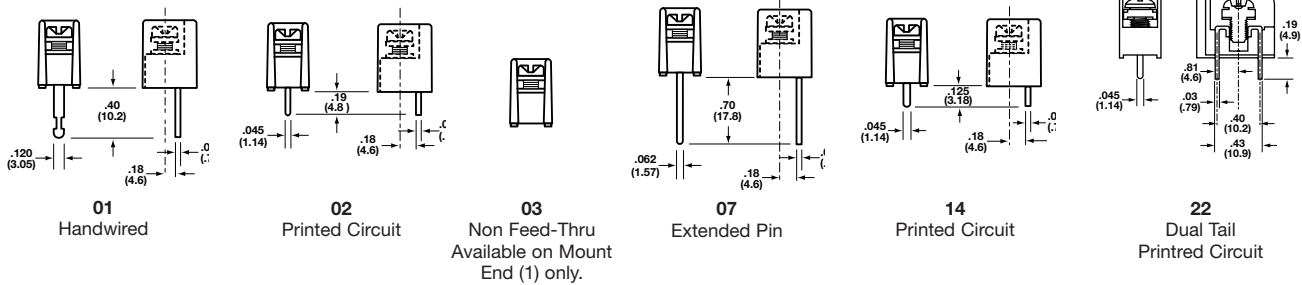

Screw Options

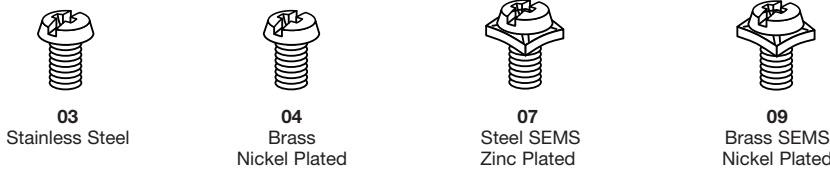

* NOTE: Wire ready screws standard on all terminal styles.

CB2 Terminal Exit Options

Inches (Millimeters)

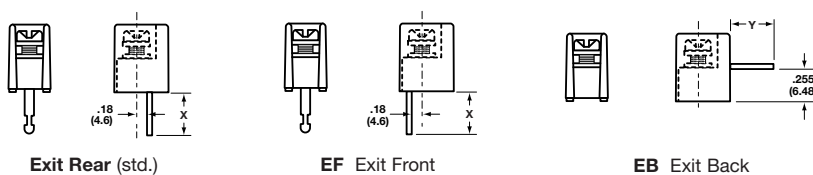

Series CB2000

Single Row Terminal Blocks

Hardware Options (Bulk ordering part numbers are in parentheses.)

Inches (Millimeters)

Solder Lugs

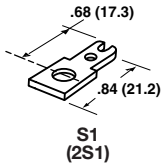

Jumpers

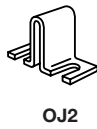
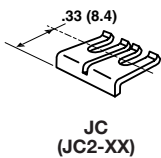
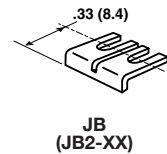
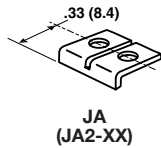

Quick Connects

Blade Width A = .250". Blade Width B = .187".

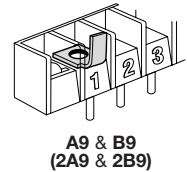
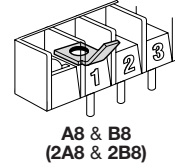
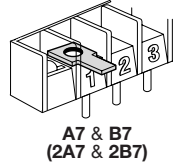

Mounting Options

Inches (Millimeters)

Right Angle Mounting Bracket

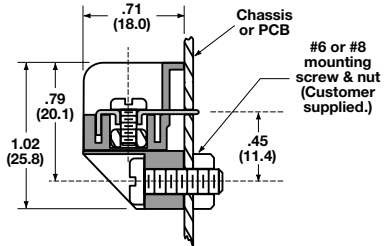
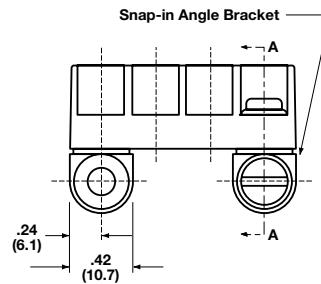
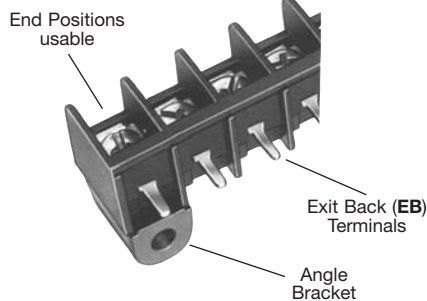

Mounts blocks on PC boards at a right angle.

- Protects solder joints.
- Recommended for all EB (Exit Back) PCB terminal blocks.
- Bracket snaps securely on block (no hardware required).
- Minimum strip length (end positions are usable).
- Mount with #6-32 or #8-32 screws (not supplied).

Option AB

Mounting Plates

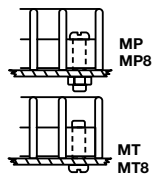
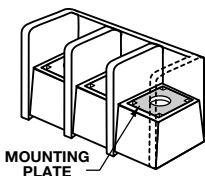

Options MP, MP8, MT & MT8

- MP** Metal inserts with .150" dia. hole accept #6 screw.
- MP8** Metal inserts with .187" dia. hole accept #8-32 screw.
- MT** Metal inserts with tapped hole accept #6-32 screw.
- MT8** Metal inserts with tapped hole accept #8-32 screw.

Series A3000, LP3000 & CB3000

Single Row Terminal Blocks

SPECIFICATIONS

Rating: A3: 30A, 600V* #12-22 AWG
 LP3: 30A, 150V #12-22 AWG
 CB3: 30A, 600V #12-22 AWG

Wire Range: #12-22 AWG CU

Center Spacing: .437" or 7/16" (11.10 mm)

Screw Size: #6-32 zinc plated phillips screws.

Torque Rating: 9 in-lb.

Base: Standoffs standard for easy flux washing.

Distance Between Barriers: .32" (8.1 mm)

Recommended PCB Hole Diameter: .076" (1.93 mm)

Operating Temperature: 105°C (221°F) max., -40°C (-40°F) min.

Molded Material: Black, UL Rated 94V0 Thermoplastic

Breakdown Voltage: 3500V (A3 & LP3); 8200V (CB3)

Agency Information: UL/CSA; IEC Compliance, CE Certified

A31940707WR

LP301105

CB31420807

A3000 & LP3000 Series

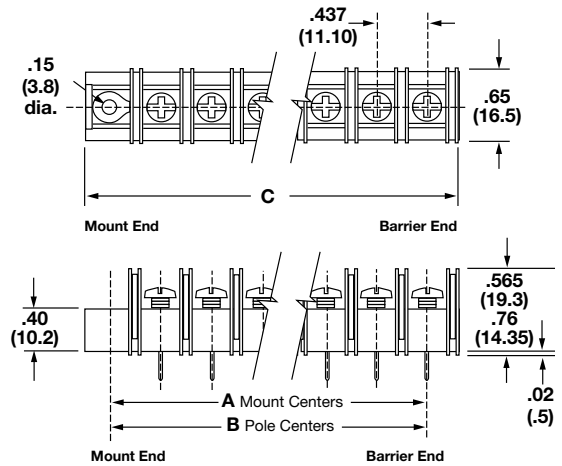

CB3000 Series

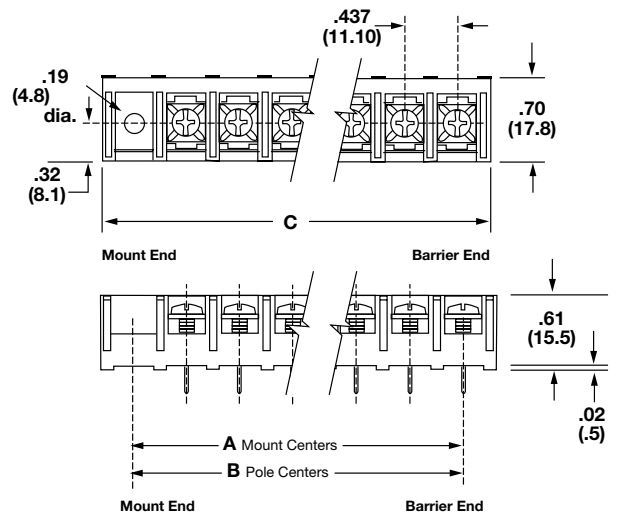

*30A Rating achieved with a #10 copper wire crimped to a ring terminal;
 20 Rating without ring terminal.

Poles	MOUNTING ENDS ONLY		BARRIER & MOUNTING ENDS Pole Ctrs.	BARRIER ENDS ONLY C Length
	A Mount Ctrs.	C Length		
02	1.31	1.73	.43	.98
03	1.75	2.17	.87	1.43
04	2.18	2.61	1.31	1.87
05	2.62	3.05	1.75	2.31
06	3.06	3.48	2.18	2.75
07	3.50	3.92	2.62	3.18
08	3.93	4.36	3.06	3.62
09	4.37	4.80	3.50	4.06
10	4.81	5.23	3.93	4.50
11	5.25	5.67	4.37	4.93
12	5.68	6.11	4.81	5.37
13	6.12	6.55	5.25	5.81
14	6.56	6.98	5.68	6.25
15	7.00	7.42	6.12	6.68
16	7.43	7.86	6.56	7.12
17	7.87	8.30	7.00	7.56
18	8.31	8.73	7.43	8.00
19	8.75	9.17	7.87	8.43
20	9.18	9.60	8.31	8.87
21	9.62	10.05	8.75	9.31
22	10.06	10.48	9.18	9.75
23	10.50	10.92	9.62	10.18
24	10.93	11.36	10.06	10.62
25	11.37	11.80	10.50	11.06
26	11.81	12.23	10.93	11.50
27			11.37	11.93
28			11.81	12.37

Dimensions in inches. To convert to millimeters, multiply by 25.4.

Series A3000 & LP3000

Single Row Terminal Blocks

Part Numbering System

Series	Terminal Style	Base/End (Views pg. 15)	Poles	Screw Options	Options
A3					
LP3					
A3 - standard barrier LP3 - low profile barrier	01 - handwired 02 - printed circuit 03 - non feed-thru 04 - wire wrap tail 05 - extended handwired 06 - handwired 07 - extended pin 08 - printed circuit 09 - .250 QC short 10 - .187 QC 14 - printed circuit 19 - .250 QC long	1 - flat base/mnt. end 2 - flat base/barrier end 3 - insulator base/mnt. end 4 - insulator base/barrier end 5 - closed base/mount end	02 to 28 02 to 26 on mount end base	Blank - std. screw 00 - screws shipped bulk 03 - stainless steel 04 - brass nickel plated 07 - steel SEMS zinc plated (not available with hardware options) 09 - brass SEMS nickel plated (not available with hardware options) 03CA - stainless steel captive 04CA - brass captive 07CA - SEMS captive 09CA - brass SEMS captive 07WR - steel SEMS wire ready (A3 only)	AB - angle mnt. options (pg 15) A1 to A9 - .250" QC B1 to B9 - .187" QC DR - drilled right angle (pg 15) J201 - flat slip-on jumper L1 to L6 marking options (pg 22) MP, MP8 & MT mounting plates (pg 15) OJ3, OJ5 & OJ7 - over barrier jumpers RC - retaining clips (pg 15) R30 to R77 - right angle bends (pg 15) SO - stand off insulators (pg 15) S1 - solder lug/flat Covers - (pg 23)

Base/End Note: 5 Style only available with 03 terminals.

Terminal Styles

Inches (Millimeters)

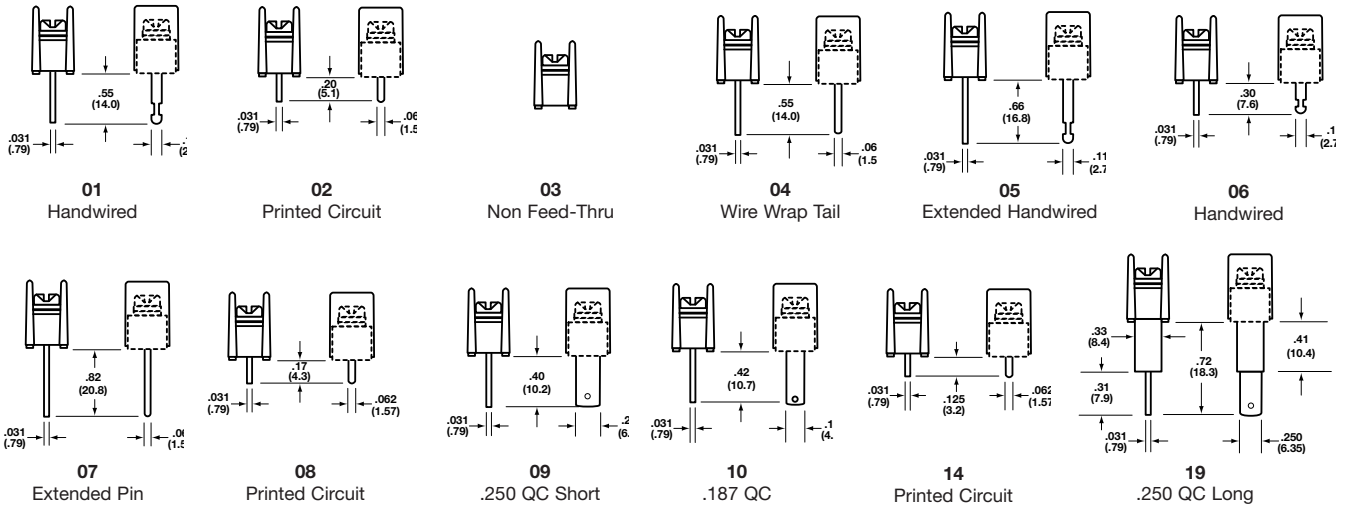

Screw Options

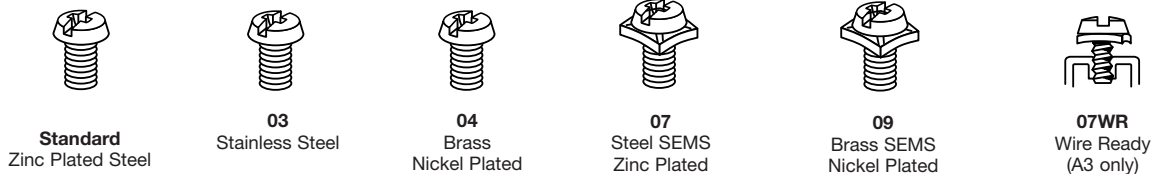

Series A3000 & LP3000 Single Row Terminal Blocks *Continued*

Hardware Options (Bulk ordering part numbers are in parentheses.)

Inches (Millimeters)

Solder Lugs

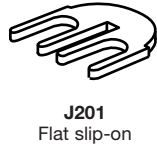
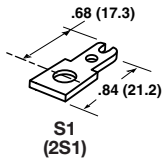

Jumpers

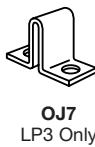
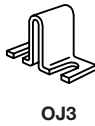

Quick Connects

Blade Width A = .250" Blade Width B = .187"

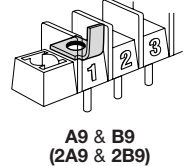
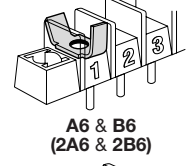
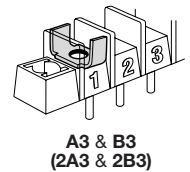
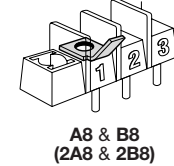
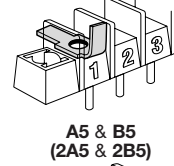
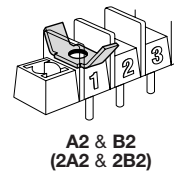
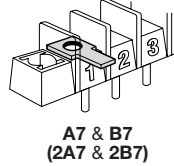
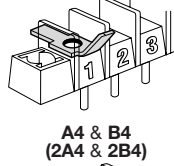
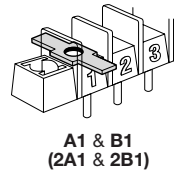

Base/End Options

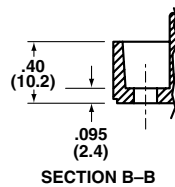
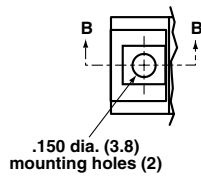

1, 3 & 5 Mount End

Series A3000 & LP3000

Single Row Terminal Blocks *Continued*

Mounting Options

Right Angle Bends (A3, LP3 only)

Right angle terminals are offered on the A3000 & LP3000 Series. Configurations are defined in these dimensions: X = pin extension beyond the block base; Z = length from block base to centerline of the terminal tip. Standard bends consist of the X and Z dimensions shown in the chart. Specify by adding the selected Bend Option Code to the terminal part no.

07 Terminal Bend Configurations

04 Terminal Bend Configurations

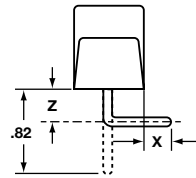
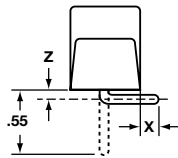

Bend Option Code	X (minimum)	Z	Available w/insulator base
R30	-.04	.28	No
R35	.01	.23	No
R36	.02	.22	No
R39	.05	.19	No
R42	.08	.16	No
R46	.12	.12	No
R48	.14	.10	No
R50	.16	.08	No

Bend Option Code	X (minimum)	Z	Available w/insulator base
R30	-.04	.55	Yes
R35	.01	.50	Yes
R36	.02	.49	Yes
R50	.16	.35	No
R53	.19	.32	No
R66	.32	.19	No
R69	.35	.16	No
R75	.41	.10	No
R77	.43	.08	No

Dimensions in inches. To convert to millimeters, multiply by 25.4.

Angle Brackets (A3, LP3 only)

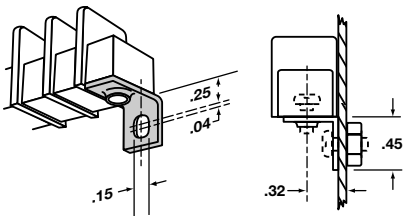

Option AB

Angle brackets enable block to be fastened at right angles to normal mount position. Bulk part no. **2AB**.

Drilled Right Angle (A3, LP3 only)

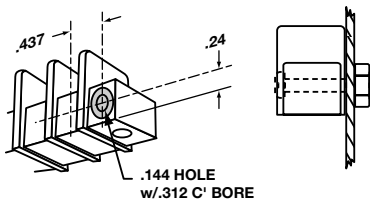

Option DR

Counterbored holes across mount ends of block enable fastening with two screws at right angles to normal mount position.

Mounting Plates

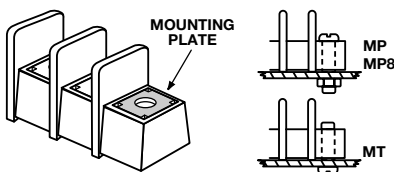

Options MP, MP8 & MT

MP Metal inserts with .150" dia. hole accept #6 screw. **MP8** Metal inserts with .187" dia. hole accept #8-32 screw. **MT** Metal inserts with tapped hole accept #6-32 screw.

Standoffs

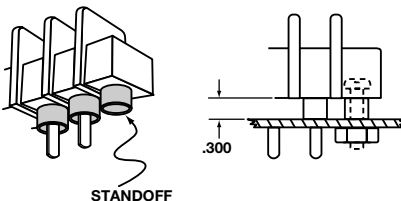

Option SO

Standoff mounts are tubes molded to the mounting positions. Available with insulator bases only.

Retaining Clip

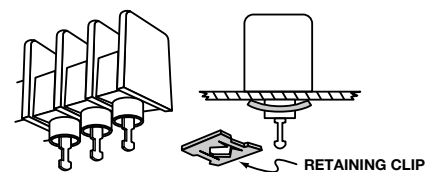

Option RC

Use on standoff tubes. Fit panels up to .125" thick. Two clips for every five positions. Supplied unassembled. Bulk Part No. **H541**.

Series CB3000

Single Row Terminal Blocks

Part Numbering System

Series	Terminal Style	Base/End	Poles	Screws	Options
C B 3					
CB3 - closed back	01 - handwired #6-32 screw 02 - printed circuit #6-32 screw 03 - non feed-thru #6-32 screw 07 - extended pin #6-32 screw 14 - printed circuit #6-32 screw 51 - handwired #8-32* 52 - printed circuit #8-32* 53 - non feed-thru #8-32* 57 - extended pin #8-32* 64 - printed circuit #8-32*	1 - mount end 2 - barrier end 5 - closed base/ mount end	02 to 28 02 to 26 on mount end base	07 - steel SEMS 09 - brass SEMS nickel plated 07CA - SEMS captive	AB - angle mounting brackets (pg 17) A7 to A9 - .250" QC B7 to B9 - .187" QC EB - exit back terminals L1 to L6 marking options (pg 22) LT1 to LT6 marking options (pg 22) OJ3 & OJ7 - over barrier jumpers MP, MP8, MT & MT8 mtg. plates (pg 17) S1 - solder lug/flat Covers - (pg 23)
	*Note: #8-32 screw is a special with #6-32 head.	Base/End Note: 5 Style only available with 03 terminals.			

Terminal Styles

Inches (Millimeters)

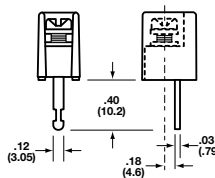

01
Handwired #6-32 screw
51
#8-32 screw

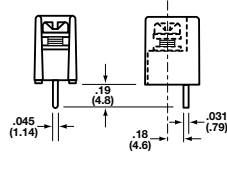

02
Printed Circuit #6-32 screw
52
#8-32 screw



03
Non Feed-Thru #6-32 screw
53
#8-32 screw
Available on Mount End (5) only.

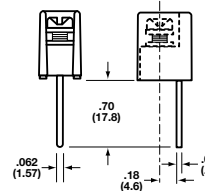

07
Extended Pin #6-32 screw
57
#8-32 screw

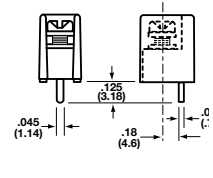

14
Printed Circuit #6-32 screw
64
#8-32 screw

Screw Options



07
Steel SEMS
Zinc Plated



09
Brass SEMS
Nickel Plated

* NOTE: Wire ready screws standard on all terminal styles.

CB3 Terminal Exit Options

Inches (Millimeters)

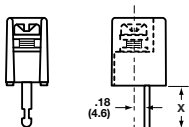

Exit Rear (std.)

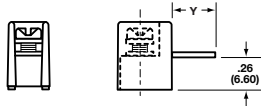

EB
Exit Back

Series CB3000

Single Row Terminal Blocks

Hardware Options (Bulk ordering part numbers are in parentheses.) Inches (Millimeters)

Solder Lugs

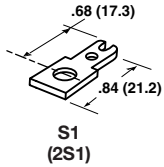

Jumpers

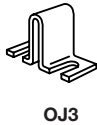
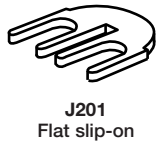

Quick Connects

Blade Width A = .250". Blade Width B = .187".

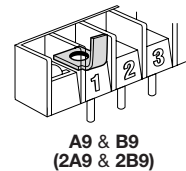
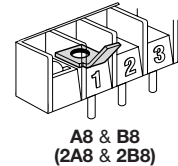
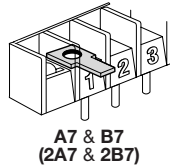

Mounting Options Inches (Millimeters)

Right Angle Mounting Bracket

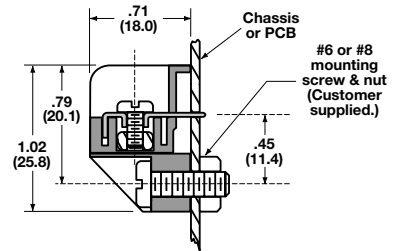
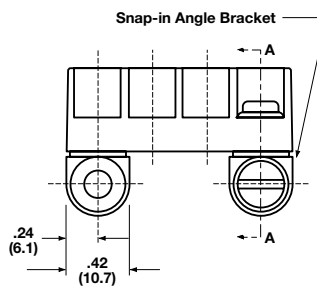
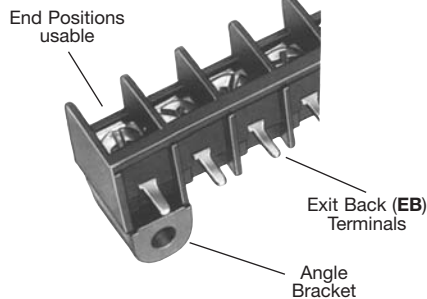

Option AB

Mounts blocks on PC boards at a right angle.

- Protects solder joints.
- Recommended for all EB (Exit Back) PCB terminal blocks.
- Bracket snaps securely on block (no hardware required).
- Minimum strip length (end positions are usable).
- Mount with #6-32 or #8-32 screws (not supplied).

Mounting Plates

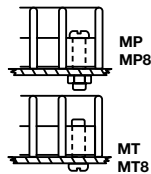
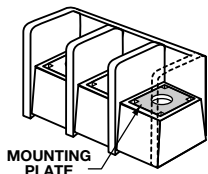

Options MP, MP8, MT & MT8

- MP** Metal inserts with .150" dia. hole accept #6 screw.
- MP8** Metal inserts with .187" dia. hole accept #8-32 screw.
- MT** Metal inserts with tapped hole accept #6-32 screw.
- MT8** Metal inserts with tapped hole accept #8-32 screw.

Series A38 / B38

Single Row Terminal Blocks

SPECIFICATIONS

Rating: A38: 30A, 600V

B38: 50A, 300V

Center Spacing: .437" (11.10 mm)

Wire Range: A38: #10-22 AWG CU; B38: #8-16 AWG

Screw Size: #8-32 Zinc Plated Steel

Torque Rating: A38: 9 in-lb; B38: 15 in-lb for #8, 9 in-lb for #6

Base: A38 Only: Standoffs standard for easy flux washing

Distance Between Barriers: .378" (9.60mm)

Recommended PCB Hole Diameter (A38): .076" (1.93mm)

Operating Temperature: 221°F (105°C)

Molded Material: Black, UL Rated 94V0 Thermoplastic

Breakdown Voltage: 5000V

Agency Information: UL/CSA; CE Certified

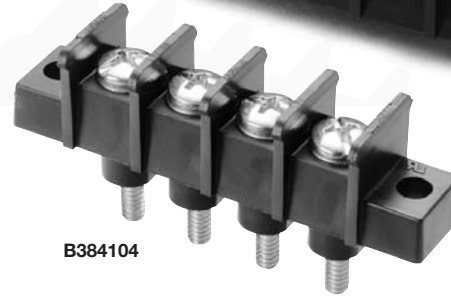
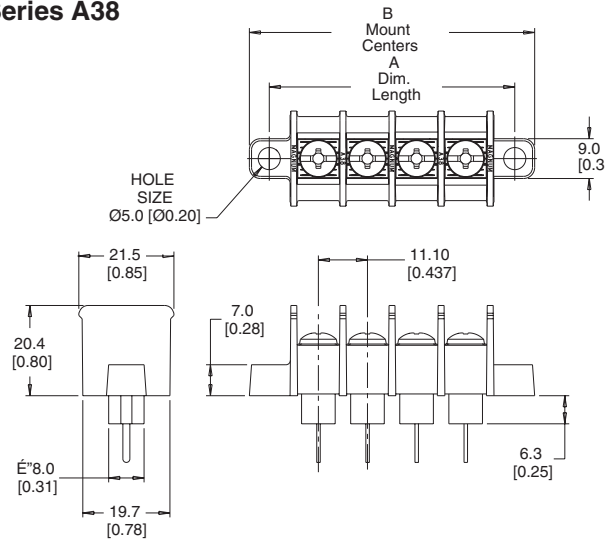

TABLE A

Poles	MOUNTING ENDS ONLY		BARRIER ENDS ONLY
	B Mount Ctrs.	"A" Dim. Length	"A" Dim. Length
02	1.31	1.67	0.93
03	1.75	2.10	1.37
04	2.19	2.54	1.81
05	2.62	2.98	2.25
06	3.06	3.41	2.68
07	3.50	3.85	3.12
08	3.93	4.29	3.56
09	4.37	4.72	3.99
10	4.81	5.16	4.43
11	5.24	5.60	4.87
12	5.68	6.04	5.30
13	6.12	6.47	5.74
14	6.56	6.91	6.18
15	6.99	7.35	6.61
16	7.43	7.78	7.05

* Dimensions in inches. To convert to millimeters, multiply by 25.4.

Series A38



Series B38

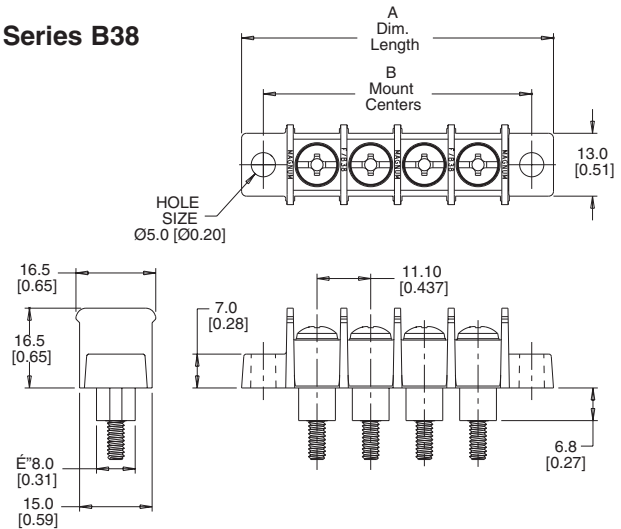

Part Numbering System

Series	Terminal Style	Base/End	# of Poles	Screw Options	Options
A38					
	<ul style="list-style-type: none"> 1 - hand wired 2 - printed circuit 7 - extended wire wrap 9 - .250" QC 	<ul style="list-style-type: none"> 1 - flat base, mount end 2 - flat base, barrier end 3 - insulator base* mount end 4 - insulator base* barrier end <p>*N/A on 2 & 8 terminal styles.</p>	02 to 16	<ul style="list-style-type: none"> Blank - standard screw (steel zinc plated, phislot BHMS) 04 - brass, nickel plated, phislot BHMS 07 - steel, SEMS zinc plated phislot screw 92 - steel, zinc plated slotted BHMS 94 - brass, nickel plated slotted BHMS 	<ul style="list-style-type: none"> L1 to L6 marking options (pg 22) RC - retaining clips (pg 15) Covers - (pg 23) R XX consult factory for terminal bend
B38					
	<ul style="list-style-type: none"> 1 - long turret 2 - short turret 3 - screw terminal #6-32 screw top & bottom) 4 - stud (#8-32 screw top, #6-32 stud bottom) 5 - double stud (#6-32 stud top & bottom) 	<ul style="list-style-type: none"> 0 - flat base, mount ends 4 - insulator base, barrier ends 9 - insulator base mount ends 	02 to 16	<ul style="list-style-type: none"> Blank - standard screw steel zinc plated phislot BHMS 04 - brass, nickel plated, phislot BHMS 32 - #6-32 zinc plated steel phislot BHMS* 34 - #6-32 nickel plated brass phislot BHMS* 92 - steel, zinc plated slotted BHMS 94 - brass, nickel plated slotted BHMS 	<ul style="list-style-type: none"> L1 to L6 marking options (pg 23) RC - retaining clips (pg 16) Covers - (pg 23) <p>*Note: 32 & 34 screws only available with 3 terminal style.</p>

A38 Terminal Styles Wire ready screws standard

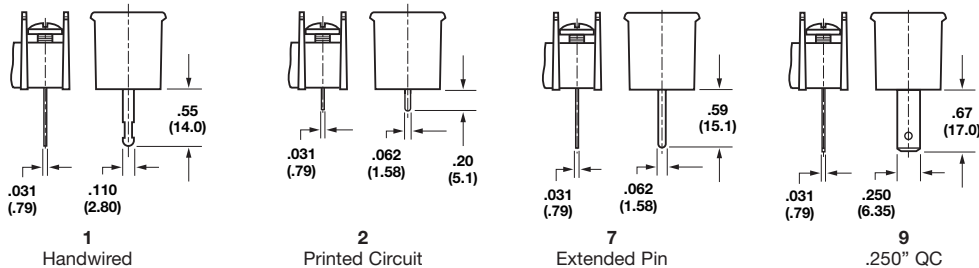

B38 Terminal Styles

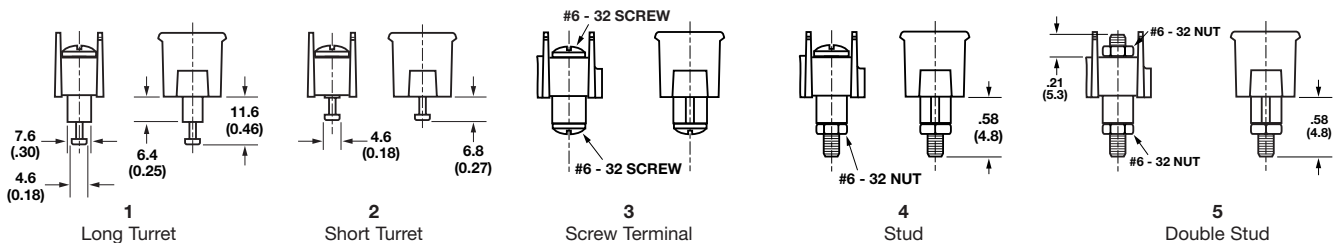

Screw Options

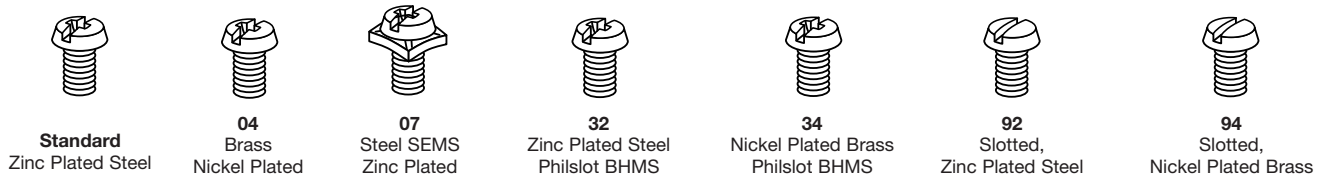

Series A4000 & Series B4000

Single Row Terminal Blocks

SPECIFICATIONS

Rating: See table.

Center Spacing: .562" or 9/16" (14.28 mm)

Wire Range: See rating table.

Screw Size: #8-32 or #10-32 zinc plated slotted screws

Torque Rating: #8 screw size 16 in.-lb.; #10 screw size 20 in.-lb.

Distance Between Barriers: .47" (11.9 mm)

Operating Temperature: 105°C (221°F) max., -40°C (-40°F) min.

Molded Material: Black, UL Rated 94V0 Thermoplastic

Hardware: Bottom studs supplied with nuts assembled. Cup washers are optional on bottom studs but are not recommended with ring terminals.

Extended Hex Nuts: Optional extended, slotted hex nuts enable easier installation and removal with hex wrench or screwdriver. Available in bulk for the #10-32 studs on Series A4953 blocks. Specify part no. F582 and quantity.

Breakdown Voltage: 6100V

Agency Information: UL/CSA; CE Certified

RATING TABLE

Part Number	Terminal Top	Terminal Bottom	Wire* Range CU	Rated Voltage	Rated Current
A4003XX	# 8 Screw	#8 Stud	8-16 AWG	150V; 50 amps	
A4011XX	# 8 Screw	Solder	10-16 AWG	600V; 35 amps	
A4013XX	# 8 Screw	Solder	10-16 AWG	600V; 35 amps	
A4021XX	# 8 Screw	.250 QC	10-16 AWG	600V; 35 amps	
A4035XX	# 8 Screw	Closed	8-16 AWG	600V; 50 amps	
A4041XX	#10 Screw	Solder	10-16 AWG	600V; 35 amps	
A4043XX	#10 Screw	Solder	10-16 AWG	600V; 35 amps	
A4051XX	#10 Screw	250 QC	10-16 AWG	600V; 35 amps	
A4803XX	#10 Screw	#8 Stud	8-16 AWG	150V; 50 amps	
A4813XX	#10 Screw	Solder Turret	10-16 AWG	600V; 35 amps	
A4843XX	#10 Screw	#8 Screw	8-16 AWG	150V; 50 amps	
A4953XX	#10 Stud	#10 Stud	8-16 AWG	150V; 50 amps	
B4843XX	#10 Screw	#8 Screw	8-16 AWG	600V; 50 amps	

* All models 30A Max. with 10 AWG;
35-50A ratings with 8 AWG using ring or fork type terminals.
Note: 50A rating achieved with #8 copper wire crimped to ring terminal.

Poles	A (in.) Mount Centers	B (in.) Length
2	1.69	2.12
3	2.25	2.68
4	2.81	3.24
5	3.37	3.80
6	3.93	4.36
7	4.50	4.93
8	5.06	5.34
9	5.62	6.05
10	6.18	6.61
11	6.74	7.17
12	7.31	7.74
13	7.87	8.30
14	8.43	8.86
15	8.99	9.44
16	9.55	9.98
17	10.12	10.55
18	10.68	11.11

* Dimensions in inches. To convert to millimeters, multiply by 25.4.

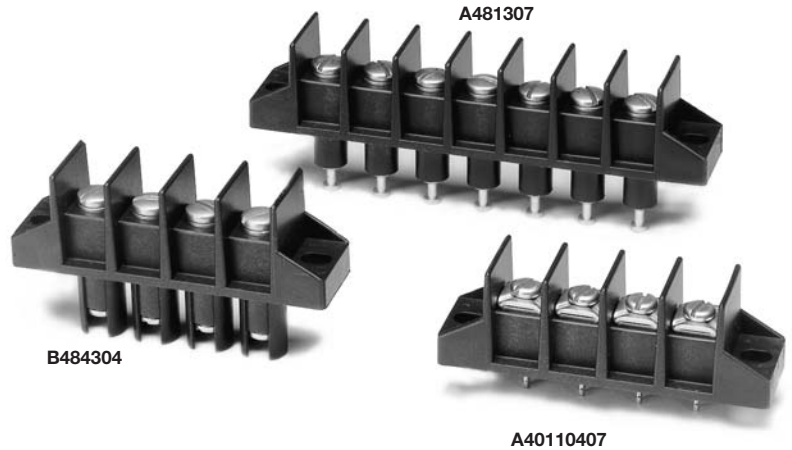

A4000 Series

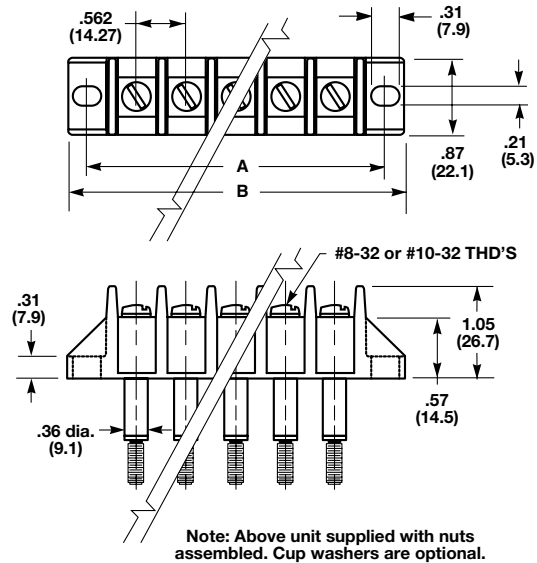

Optional Cup Washers Assembled

Available on A4003, A4803, A4843, A4953 & B4843.

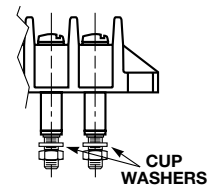

Reference Panel Cutout for 6 Position Block

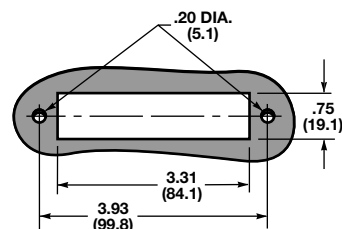

Part Numbering System

Series



A4 - standard
B4 - barrier

Terminal Style



00 - screw top; stud bottom
01 - screw top; solder bottom
02 - #8 screw top; .250 QC bottom
03 - screw top only
04 - #10 screw top; solder term. b.
05 - #10 screw top; .250 QC bottom
80 - screw top; stud bottom insulated base
81 - screw top; solder turret bottom
84 - screw top; screw bottom
95 - stud top; stud bottom

Base/End



1 - flat base/
mount end
3 - insulator base/
mount end
5 - closed base/
mount end

Poles



02 to 18

Screw Options



Blank - std. screw
00 - screws shipped bulk
04 - brass nickel plated
07 - steel SEMS zinc plated (not available with hardware options; not available on A4003, A4803, A4813, A4843, B4843)

Options



A1 to A9 - .250" QC
CW - cup washer (pg 20)
J301 - flat slip-on jumper (2 position only)
L1 to L6 marking options (pg 22)
S1 & S2 - solder lugs/flat
Covers - (pg 23)

Terminal Styles

Inches (Millimeters)

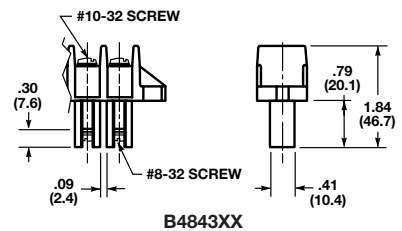
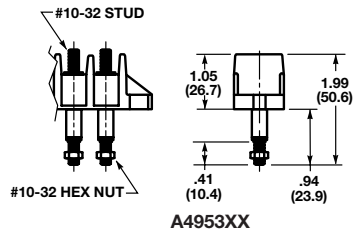
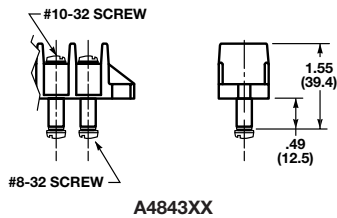
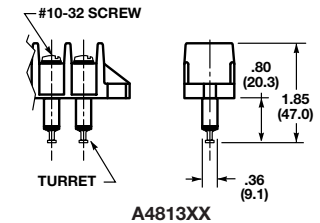
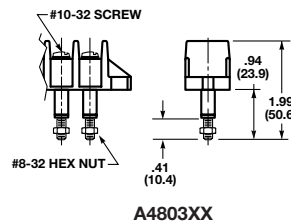
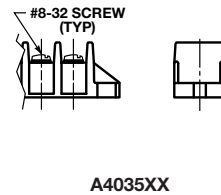
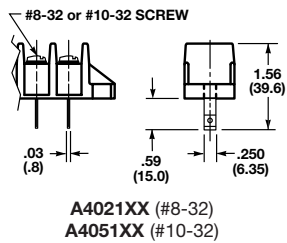
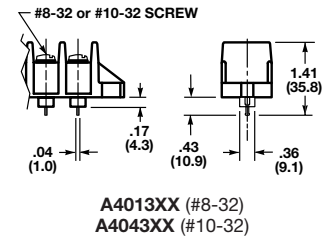
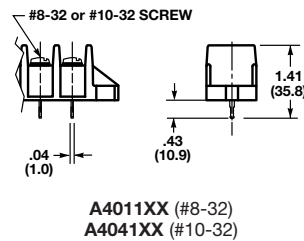
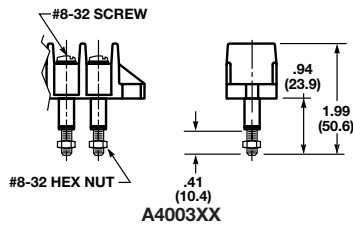

Hardware Options (Bulk ordering part numbers are in parentheses.)

Inches (Millimeters)

Solder Lugs

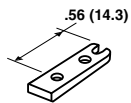

S1
(2S1)

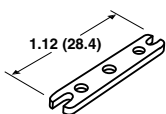

S2
(2S2)

Jumpers



J301

Quick Connects Blade Width A = .250". (For other orientations, contact factory.)

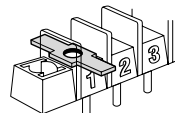

A1
(4A1)

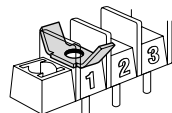

A2
(4A2)

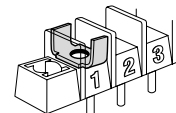

A3
(4A3)

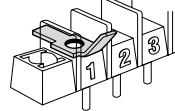

A4
(4A4)

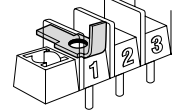

A5
(4A5)

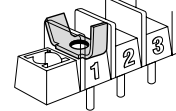

A6
(4A6)

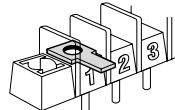

A7
(4A7)

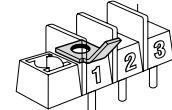

A8
(4A8)

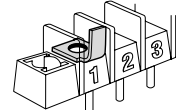

A9
(4A9)

All Series Marking Options

Single Row Terminal Blocks

Marking Options & Accessories

Standard Marking

Markings are applied directly to the sides of Series 1000, 2000, 3000, & 4000. Standard characters are white and 1/8" high. Factory may substitute 3/32" high characters.

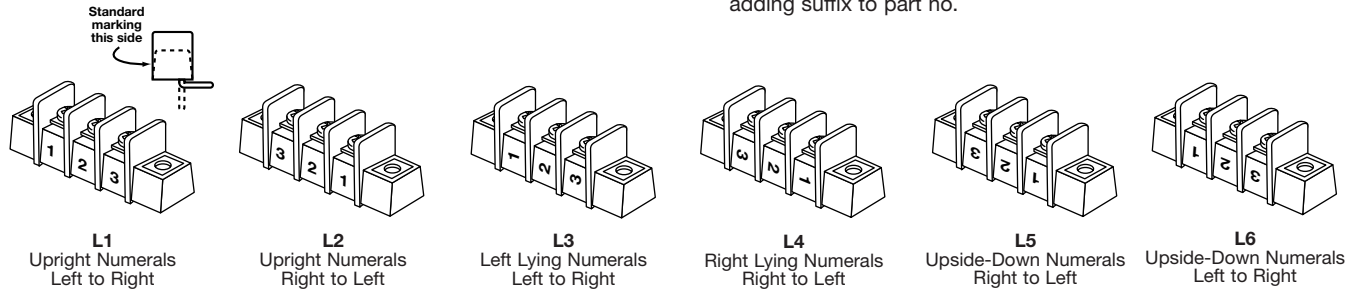

Blocks to be marked on both sides require a different code for each side. Example: "L1" on one side of the block requires "L2" on the other side to ensure common terminal marking. Specify by adding suffix to part no.

Special Marking

Special markings are available for Series 1000, 2000, 3000, 4000 & 5000 at an additional charge for preparation. Production charges for setup, handling and marking are the same as for standard marking and the same quantity discounts apply. Consult factory for price and delivery.

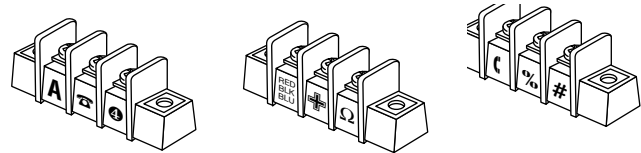

Closed Barrier Terminal Block Marking Options

L1 & LT1 = Upright numerals, numbered from left to right
 L2 & LT2 = Upright numerals, numbered from right to left
 L3 = Left lying numerals, numbered from left to right
 L4 = Right lying numerals, numbered from right to left
 L5 & LT5 = Upside down numerals, numbered from right to left
 L6 & LT6 = Upside down numerals, numbered from left to right

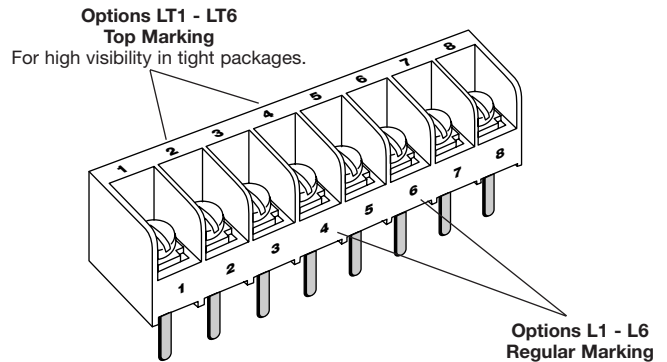

Marker Strips

Black marker strips with white numerals mount beneath the terminal blocks to clearly identify terminal and wire positions. Available with forward or reverse markings, top or bottom of strip. If special markings are required, submit a drawing.

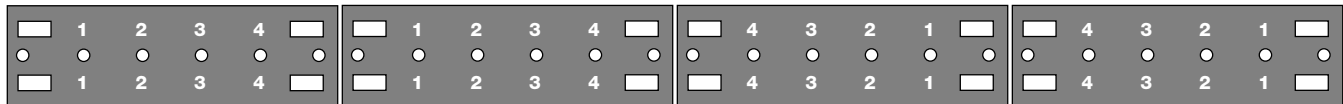

Bottom Forward - BF

Top Forward - TF

Bottom Reverse - BR

Top Reverse - TR

Series



MS1 - 1000 Series
MS2 - 2000 Series
MS3 - 3000 Series

Base



1 - mount end, feed thru
2 - barrier end, feed thru
3 - mount end, insulator tubes
4 - barrier end, insulator tubes
5 - mount end, non feed-thru

Poles



02 to 36

Marking



BF - bottom forward
TF - top forward
BR - bottom reverse
TR - top reverse

All Series Accessories

Single Row Terminal Blocks *Continued*

Cover Options - Single Row

Terminal Block Covers

Available for Series A1000, A2000, A3000, A4000, CB2000, CB3000, LP2000, & LP3000.
Three styles of UL 94V0 thermoplastic covers are offered in yellow or black. Covers are ordered separately and supplied with two clips each, unless ordered without clips. Optional markings may be specified (black on yellow; white on black).

Notes: Covers can not be used with mounting plate options MP & MT.
Covers can not be used with certain quick connect terminals.
Covers can not be used with 0, 6, & 9 base/end styles on A2 or A3

Bulk Cover Clips: Series 1000 = **CC1**; Series 2000 & 3000 = **CC2**;
Series 4000 = **CC4**.

Standard Cover Markings

Top Forward - **TF**

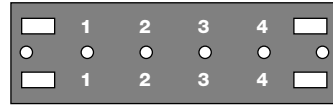

Bottom Forward - **BF**
Skirted Access Side

Top Reverse - **TR**

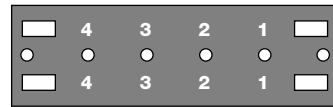

Bottom Reverse - **BR**
Skirted Access Side

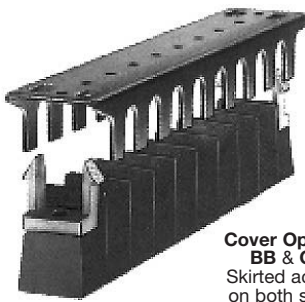

**Cover Options
BB & CB**
Skirted access
on both sides.

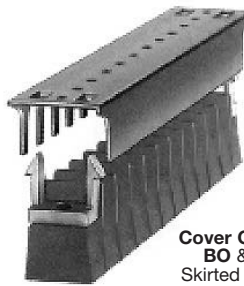

**Cover Options
BO & CO**
Skirted access
on one side only.

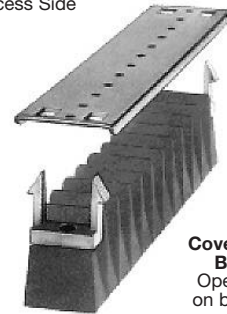

**Cover Options
BC & TC**
Open access
on both sides.

Cover



BB - skirted access, both sides, black
CB - skirted access, both sides, yellow
BO - skirted access, one side, black
CO - skirted access, one side, yellow
BC - open access, both sides, black*
TC - open access, both sides, yellow*
* Not available in 4000 Series

Series



1 - 1000
2 - 2000
3 - 3000
4 - 4000

Poles



02 to 36

Markings



BF - bottom forward
TF - top forward
BR - bottom reverse
TR - top reverse

Options



00 - without clips

Snap-On Covers for A38/B38/F38 Series & CB2/CB3 Series

A38/B38 Series

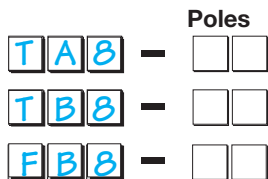

A38 Series

B38 Series

F38 Series

CB2/CB3 Series

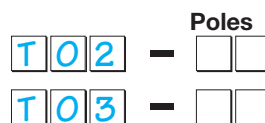

CB2 Series

CB3 Series