

SMD

Rated voltage 42 Vac/80 Vdc
Rated current 100 to 600 mA
Rated inductance 4,7 to 50 mH

**Construction**

- Current-compensated ring core choke with ferrite core
- Bifilar winding

Features

- Case flame-retardant as per UL 94 V-0
- Suitable for reflow soldering

Anwendungen

- Suppression of asymmetrical interference coupled in on lines, whereas data signals up to some MHz can pass unaffectedly
- Telecom interfaces
- ISDN systems

Terminals

- Tinned

Marking

Manufacturer, ordering code,
date of manufacture (month, year)

Delivery mode

Blister tape, reel packing

For details on taping, packing and packing units [see page 302](#)

Double Chokes

SMD

Dimensional drawing

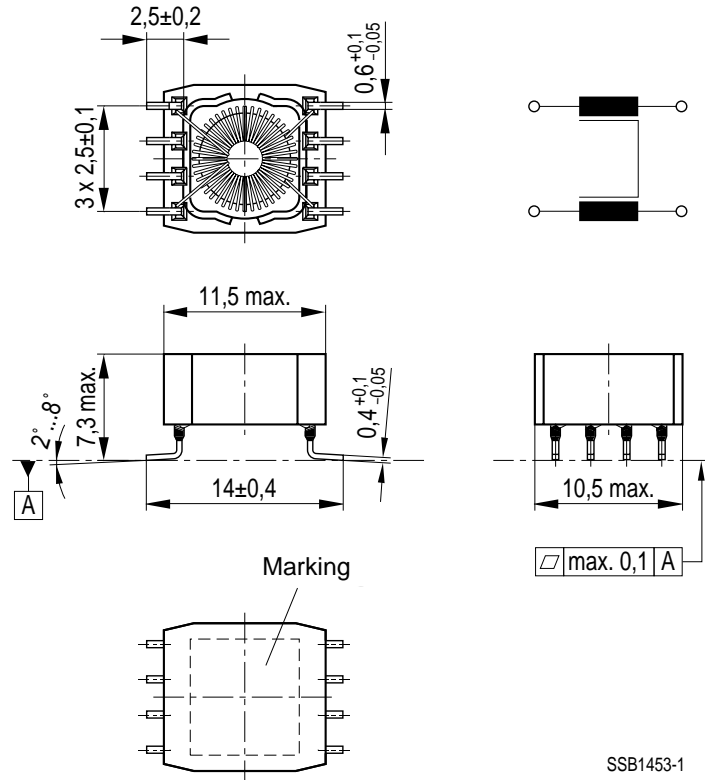

SSB1453-1

Layout recommendation

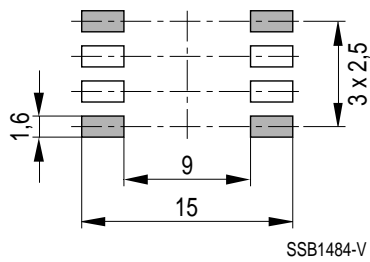

SSB1484-V

General technical data

Rated voltage V_R	42 Vac (50/60 Hz) 80 Vdc
Rated current I_R	Referred to 50 Hz and 60 °C ambient temperature
Rated inductance L_R	Measured with HP 4275A at 10 kHz and 10 mV (specified per winding)
Inductance tolerance	- 30/+ 50 %
Inductance decrease $\Delta L/L_0$	< 10 % at dc magnetic bias with I_R
Stray inductance L_S	Measured at 10 kHz and 10 mV
DC resistance R_{typ}	Typical values, measured at 20 °C ambient temperature
Solderability	(215 ± 3) °C, (3 ± 0,3) s wetting of soldering area ≥ 95 % in accordance with IEC 60068-2-58
Climatic category	40/125/56 (- 40 °C/+ 125 °C/56 days damp heat test) in accordance with IEC 60068-1
Weight	Approx. 2 g

Characteristics and ordering codes

L_R mH	L_S, typ nH	I_R mA	R_{typ} Ω	V_T Vdc, 2 s	Ordering code
4,7	500	600	0,4	1000	B82792-C0475-N365
6,8	500	600	0,5	750	B82792-C0685-N365
10	600	500	1,1	750	B82792-C0106-N365
22	800	200	1,6	750	B82792-C0226-N365
33	1500	100	2,0	750	B82792-C0336-N365
50	1700	100	2,6	750	B82792-C0506-N365

Double Chokes



Insertion loss α_e (typical values at $Z = 50 \Omega$)

———— asymmetrical, all branches in parallel (common mode)

- - - - - symmetrical (differential mode)

B82792-C0475-N365

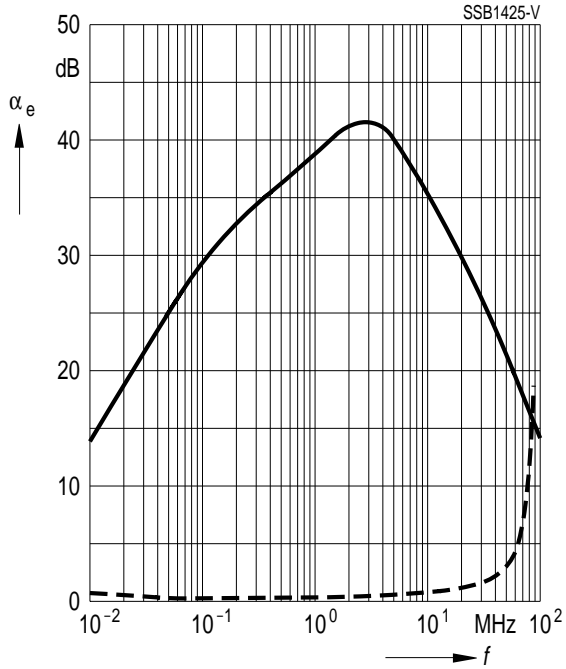

B82792-C0685-N365

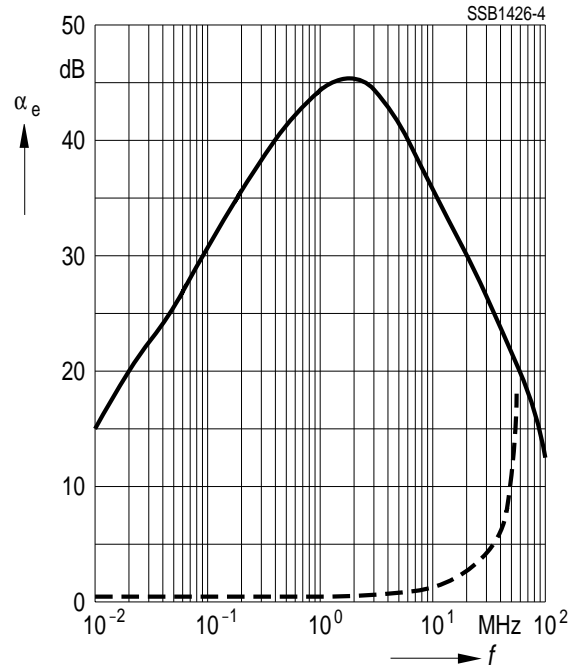

B82792-C0106-N365

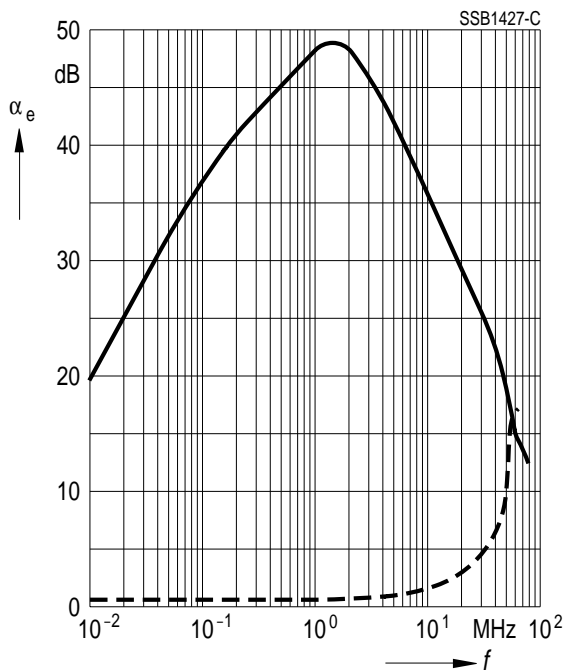

B82792-C0226-N365

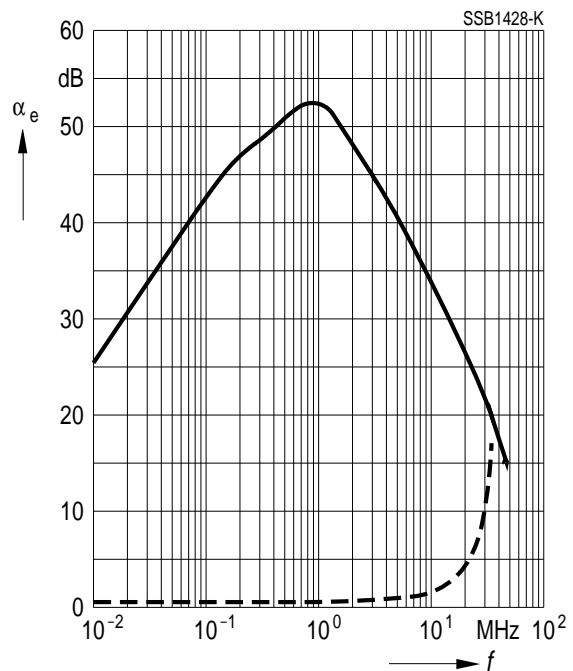

Double Chokes



Insertion loss α_e (typical values at $Z = 50 \Omega$)

———— asymmetrical, all branches in parallel (common mode)

- - - - - symmetrical (differential mode)

B82792-C0336-N365

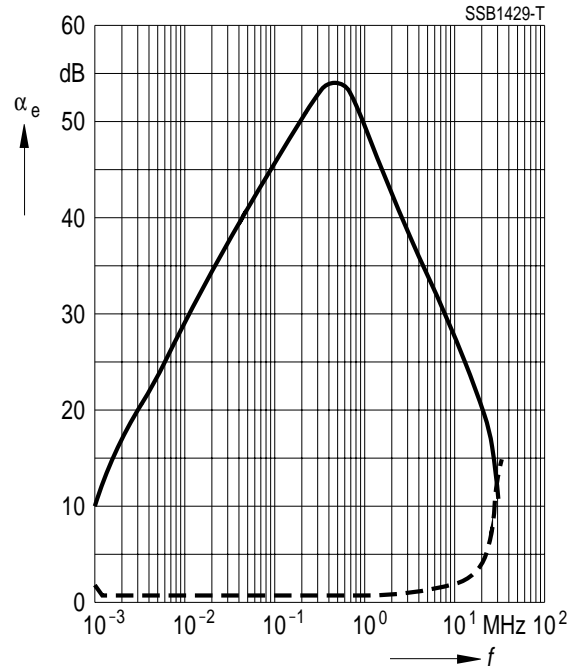

B82792-C0506-N365

