

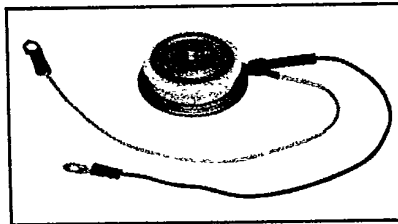

C430__X550

Powerex, Inc. Hillis Street, Youngwood, Pennsylvania 15697 (412) 925-7272
 Powerex Europe, S.A., 428 Ave. G. Durand, BP107, 72003 LeMans, France (43) 72.75.15

Phase Control SCR
800 Amperes Avg
100-400 Volts

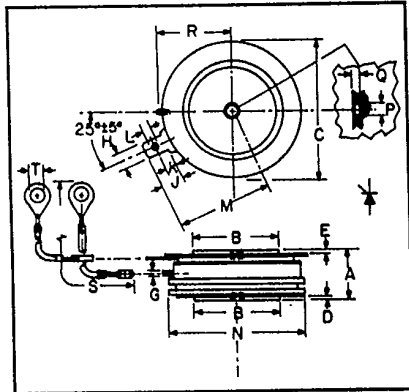

C430__X550
Phase Control SCR
 800 Amperes/100-400 Volts

C430__X550
Outline Drawing

Dimensions	Inches		Millimeters	
	Min.	Max.	Min.	Max.
A	.560	.605	14.22	15.37
B	.985	.995	25.01	25.27
C	1.600	1.650	40.64	41.91
D	.030	—	.76	—
E	.040	—	1.01	—
G	.057	.059	1.44	1.50
H	.186	.191	4.72	4.85
J	.245	.255	6.22	6.48
K	.115	.130	2.92	3.30
L	.064	.070	1.62	1.78
M	—	1.120	—	28.45
N	—	1.585	—	40.26
P	.135	.145	3.42	3.68
Q	.070	.084	1.77	2.13
R	—	.875	—	22.23
S	12.219	12.343	310.36	313.51
T	.137	.153	3.47	3.89

Description

Powerex Silicon Controlled Rectifiers (SCR) are designed for phase control applications. These are all-diffused, Press-Pak (Pow-R-Disc) devices employing the field-proven amplifying (di/namic) gate.

Features:

- Low On-State Voltage
- High di/dt
- High dv/dt
- Hermetic Packaging
- Excellent Surge and I²t Ratings
- High Temperature Operation

Applications:

- Power Supplies
- Battery Chargers
- Motor Control
- Light Dimmers
- VAR Generators

Ordering Information

Example: Select the complete nine digit part number you desire from the table - i.e. C430DX550 is a 400 Volt, 800 Ampere Phase Control SCR.

Type	Voltage		Current
	V _{ORM} V _{RRM}	Code	
C430__X550	100	A	800
	200	B	
	300	C	
	400	D	



Powerex, Inc., Hillis Street, Youngwood, Pennsylvania 15697 (412) 925-7272

Powerex Europe, S.A., 428 Ave. G. Durand, BP107, 72003 LeMans, France (43) 72.75.15

C430_X550

Phase Control SCR

800 Amperes Avg/100-400 Volts

Absolute Maximum Ratings

	Symbol	C430_X550	Units
RMS On-State Current	$I_{T(RMS)}$	1250	Amperes
Average On-State Current	$I_{T(av)}$	800	Amperes
Peak One-Cycle Surge (Non-Repetitive) On-State Current (60Hz)	I_{TSM}	9000	Amperes
Peak One-Cycle Surge (Non-Repetitive) On-State Current (50Hz)	I_{TSM}	8200	Amperes
Critical Rate-of-Rise of On-State Current (Non-Repetitive)	di/dt	400	Amperes/ μ s
Critical Rate-of-Rise of On-State Current (Repetitive)	di/dt	150	Amperes/ μ s
I^2t (for Fusing), One Cycle at 60Hz	I^2t	335,000	A ² sec
Peak Gate Power Dissipation	P_{GM}	200	Watts
Average Gate Power Dissipation	$P_{G(av)}$	5	Watts
Storage Temperature	T_{STG}	-40 to 150	°C
Operating Temperature	T_J	-40 to 150	°C
Mounting Force [ⓐ]		800 to 2200	lb.
Mounting Force [ⓐ]		3.6 to 11.1	kN

[ⓐ] Consult recommended mounting procedures.



Powerex, Inc., Hillis Street, Youngwood, Pennsylvania 15697 (412) 925-7272

Powerex Europe, S.A., 428 Ave. G. Durand, BP107, 72003 LeMans, France (43) 72.75.15

C430_X550

Phase Control SCR

800 Amperes Avg/100-400 Volts

Electrical and Thermal Characteristics

Characteristics	Symbol	Test Conditions	C430_X550	Units
Voltage—Blocking State Maximums				
Forward Leakage, Peak	I_{DRM}	$T_J = 25^\circ\text{C}, V = V_{DRM}$	50	mA
Reverse Leakage, Peak	I_{RRM}	$T_J = 25^\circ\text{C}, V = V_{RRM}$	50	mA
Current—Conducting State Maximums				
Peak On-State Voltage	V_{TM}	$I_{TM} = 3000\text{A}, T_C = 25^\circ\text{C}$	1.9	Volts
Switching				
Typical Turn-Off Time	t_q	$T_J = 150^\circ\text{C}; I_{TM} = 500\text{A}, V_R = 50\text{V Min};$ V_{DRM} (Reapplied); Reapplied $dv/dt = 20\text{V}/\mu\text{sec}$ (linear); Commutation $di/dt = 25\text{A}/\mu\text{sec};$ Repetition Rate = 1pps, Gate Bias during Turn-Off interval = 0V, 100Ω	125	μsec
Typical Delay Time	t_d	$T_C = 25^\circ\text{C}, I_T = 50\text{A dc},$ Gate Supply: 20V, 20Ω, 0.1μsec Rise Time	0.7	μsec
Min. Critical dv/dt exponential to V_{DRM}	dv/dt	$T_J = 150^\circ\text{C}, V_{DRM}$ rated, gate open	100	V/μsec
Thermal and Mechanical				
Maximum Thermal Resistance, [ⓐ] double sided cooling				
Junction to Case (2000 lb. force)	$R_{\theta JC}$.04	°C/Watt
Case to Sink, Lubricated (2000 lb. force)	$R_{\theta CS}$.02	°C/Watt
Gate—Maximum Parameters				
Gate Current to Trigger	I_{GT}	$V_D = 6\text{V}, T_J = 150^\circ\text{C}, R_L = 3\text{ ohms}$	100	mA
Gate Voltage to Trigger	V_{GT}	$V_D = 6\text{V}, T_J = 150^\circ\text{C}, R_L = 3\text{ ohms}$	5	Volts
Non-Triggering Gate Voltage	V_{GDM}	$T_J = 150^\circ\text{C}, \text{rated } V_{DRM}$.15	Volts
Peak Forward Gate Current	I_{GTM}		4	Amperes
Peak Reverse Gate Voltage	V_{GRM}		5	Volts

[ⓐ] Consult recommended mounting procedures.



Powerex, Inc., Hillis Street, Youngwood, Pennsylvania 15697 (412) 925-7272
 Powerex Europe, S.A., 428 Ave. G. Durand, BP107, 72003 LeMans, France (43) 72.75.15

C430...X550
 Phase Control SCR
 800 Amperes Avg/100-400 Volts

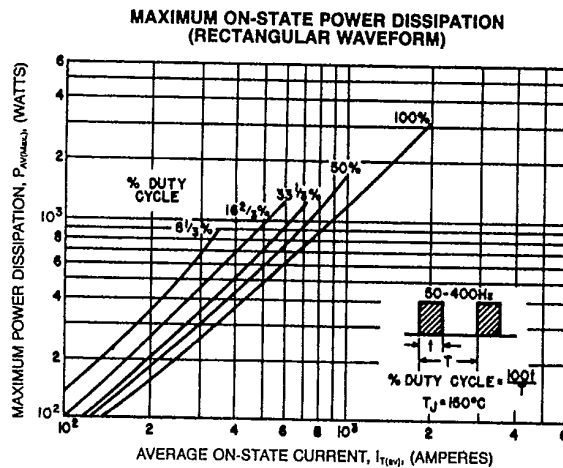
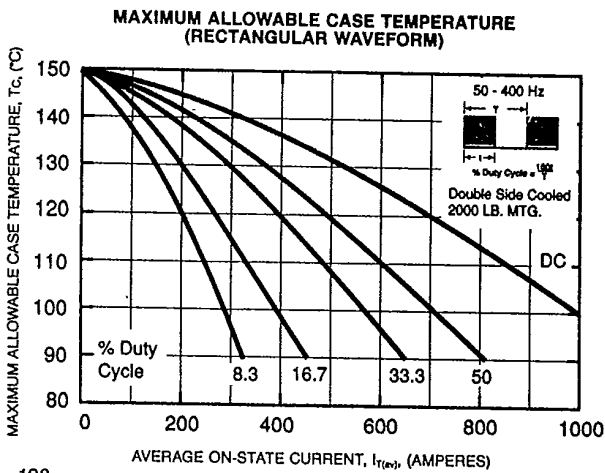
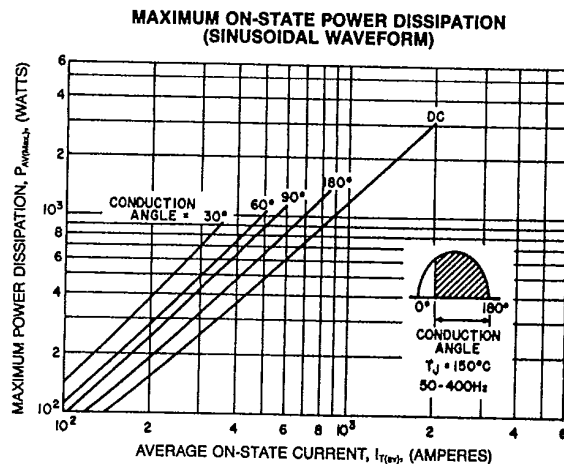
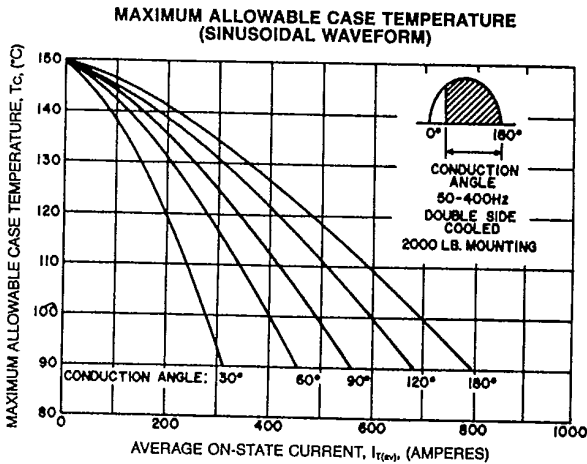
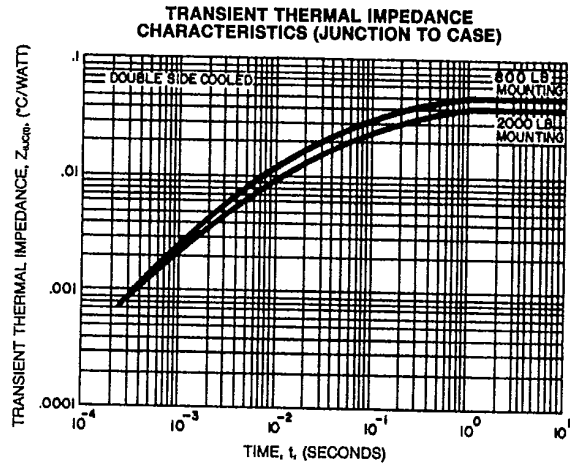
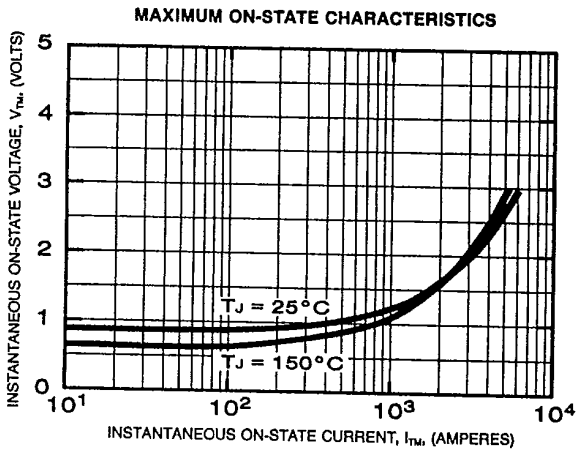



Powerex, Inc., Hillis Street, Youngwood, Pennsylvania 15697 (412) 925-7272
 Powerex Europe, S.A., 428 Ave. G. Durand, BP107, 72003 LeMans, France (43) 72.75.15

C430_X550
 Phase Control SCR
 800 Amperes Avg/100-400 Volts

SUB-CYCLE SURGE AND I²t RATINGS
 (RATED LOAD CONDITIONS)

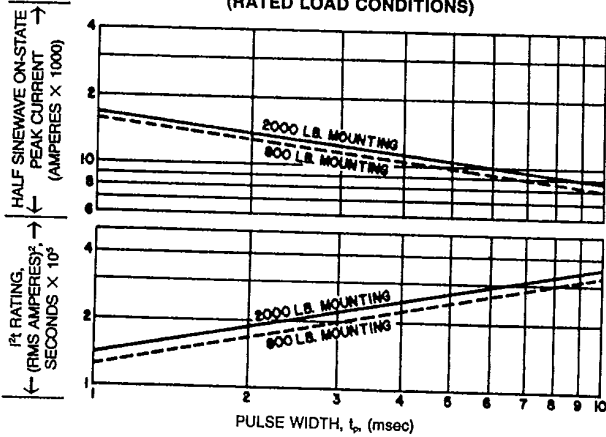

GATE CHARACTERISTICS

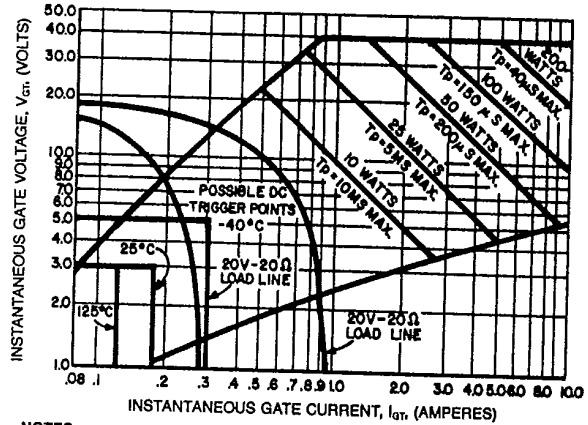

NOTES:

1. Maximum allowable average gate dissipation = 5 watts.
2. The locus of possible dc trigger points lie outside the boundaries shown at various case temperatures.
3. Tp = Rectangular gate current pulse width (5µs min. duration; 1.0µs max. rise time for 20V, 65Ω source).
4. 20V - 20Ω is the minimum gate source load line when rate of circuit current rise > 100 Amp/µs or anode rate of current rise > 200 Amps/µs (Tp = 5µs min., 0.5µs max. rise time).

Maximum long-term repetitive anode di/dt = 500 Amps/µs with 20V - 20Ω gate source.