

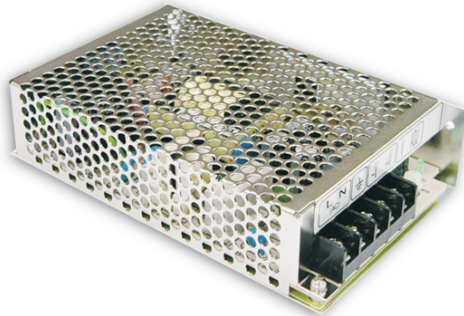

Astrodyne

60W Single Output Switching Power Supply

AS-60 series



■ Features :

- Universal AC input/Full range
- Protections:Short circuit/Over load/Over voltage
- Cooling by free air convection
- 100% full load burn-in test
- Fixed switching frequency at 50KHz

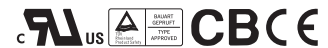

SPECIFICATION

MODEL	AS60-5	AS60-12	AS60-15	AS60-24	
OUTPUT	DC VOLTAGE	5V	12V	15V	24V
	RATED CURRENT	12A	5A	4A	2.5A
	CURRENT RANGE	0 ~ 12A	0 ~ 5A	0 ~ 4A	0 ~ 2.5A
	RATED POWER	60W	60W	60W	60W
	RIPPLE & NOISE (max.) Note.2	120mVp-p	120mVp-p	150mVp-p	150mVp-p
	VOLTAGE ADJ. RANGE	4.75 ~ 5.5V	10.8 ~ 13.2V	13.5 ~ 16.5V	21.6 ~ 26.4V
	VOLTAGE TOLERANCE Note.3	±2.0%	±1.0%	±1.0%	±1.0%
	LINE REGULATION	±0.5%	±0.5%	±0.5%	±0.5%
	LOAD REGULATION	±1.0%	±0.5%	±0.5%	±0.5%
	SETUP, RISE TIME	300ms, 50ms/230VAC 800ms, 50ms/115VAC at full load			
HOLD TIME (Typ.)	90ms/230VAC 12ms/115VAC at full load				
INPUT	VOLTAGE RANGE	85 ~ 264VAC 120 ~ 370VDC			
	FREQUENCY RANGE	47 ~ 63Hz			
	EFFICIENCY(Typ.)	73%	76%	77%	79%
	AC CURRENT (Typ.)	2A/115VAC 1A/230VAC			
	INRUSH CURRENT (Typ.)	COLD START 20A/115VAC 40A/230VAC			
	LEAKAGE CURRENT	<3.5mA / 240VAC			
PROTECTION	OVER LOAD	105 ~ 150% rated output power Protection type : Hiccup mode, recovers automatically after fault condition is removed.			
	OVER VOLTAGE	5.75 ~ 6.75V	13.8 ~ 16.2V	17.25 ~ 20.25	27.6 ~ 32.4V
ENVIRONMENT	WORKING TEMP.	-10 ~ +60°C (Refer to output load derating curve)			
	WORKING HUMIDITY	20 ~ 90% RH non-condensing			
	STORAGE TEMP., HUMIDITY	-20 ~ +85°C, 10 ~ 95% RH			
	TEMP. COEFFICIENT	±0.03%/°C (0 ~ 50°C)			
	VIBRATION	10 ~ 500Hz, 2G 10min./1cycle, period for 60min. each along X, Y, Z axes			
SAFETY & EMC (Note 4)	SAFETY STANDARDS	UL1012, UL1950, TUV EN60950 Approved			
	WITHSTAND VOLTAGE	I/P-O/P:3KVAC I/P-FG:1.5KVAC O/P-FG:0.5KVAC			
	ISOLATION RESISTANCE	I/P-O/P, I/P-FG, O/P-FG:100M Ohms/500VDC			
	EMI CONDUCTION & RADIATION	Compliance to EN55022 (CISPR22) Class B			
	HARMONIC CURRENT	Compliance to EN61000-3-2,-3			
OTHERS	EMS IMMUNITY	Compliance to EN61000-4-2,3,4,5,6,8,11; ENV50204, EN55024, Light industry level, criteria A			
	MTBF	316.2K hrs min. MIL-HDBK-217F (25°C)			
	DIMENSION	159*97*38mm (L*W*H)			
NOTE	PACKING	0.51Kg; 24pcs/13.1Kg/0.7CUFT			
		1. All parameters NOT specially mentioned are measured at 230VAC input, rated load and 25°C of ambient temperature. 2. Ripple & noise are measured at 20MHz of bandwidth by using a 12" twisted pair-wire terminated with a 0.1uF & 47uF parallel capacitor. 3. Tolerance : includes set up tolerance, line regulation and load regulation. 4. The power supply is considered a component which will be installed into a final equipment. The final equipment must be re-confirmed that it still meets EMC directives.			

Mechanical Specification

Case No. 901 Unit:mm

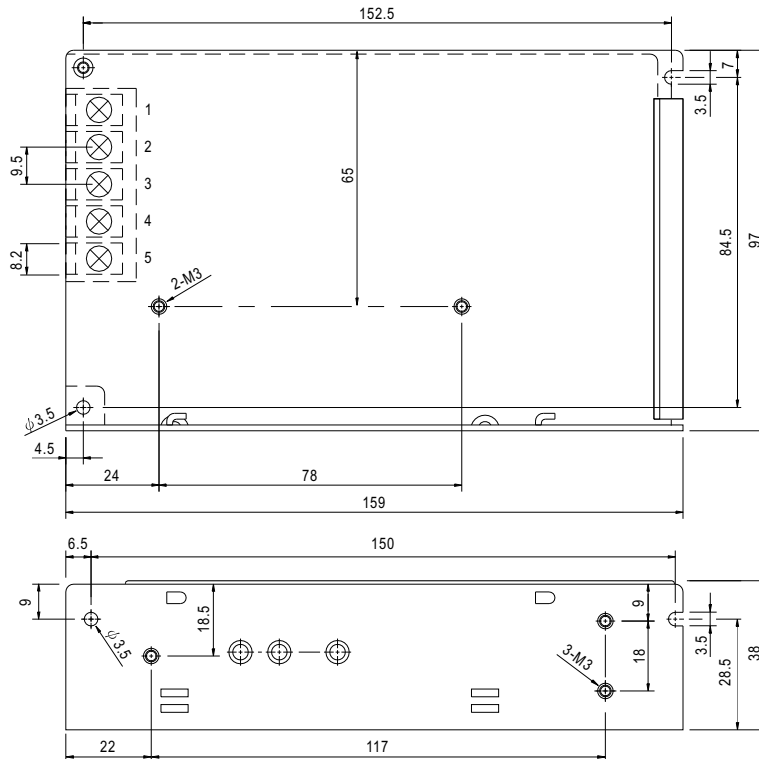

Terminal Pin. No Assignment

Pin No.	Assignment	Pin No.	Assignment
1	AC/L	4	DC OUTPUT -V
2	AC/N	5	DC OUTPUT +V
3	FG \perp		

Output Derating

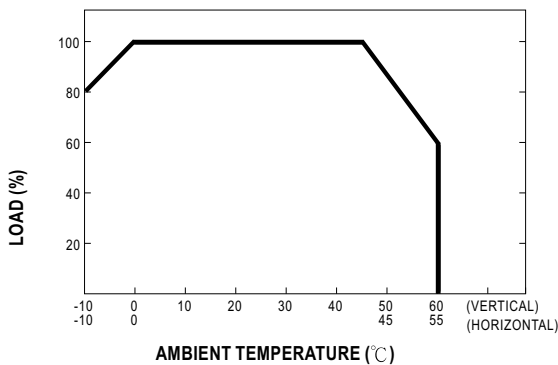

Static Characteristics (24V)

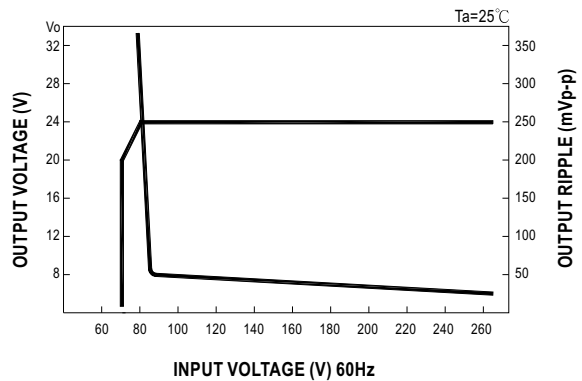



Astrodyne

60W Single Output Switching Power Supply

AD-60 series

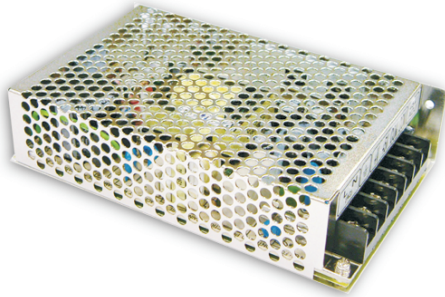

■ Features :

- Universal AC input/Full range
- Protections:Short circuit/Over load/Over voltage
- Cooling by free air convection
- LED indicator for power on
- Fixed switching frequency at 54KHz

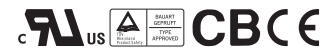

SPECIFICATION

MODEL		AD-60A		AD-60B	
OUTPUT	OUTPUT NUMBER	CH1	CH2	CH1	CH2
	DC VOLTAGE	5V	12V	5V	24V
	RATED CURRENT	4A	3A	3A	1.8A
	CURRENT RANGE	0.3 ~ 6A	0.2 ~ 4A	0.3 ~ 6A	0.2 ~ 2.2A
	RATED POWER	56W		58W	
	RIPPLE & NOISE (max.) Note.2	75mVp-p		150mVp-p	
	VOLTAGE ADJ. RANGE	CH1 : 4.75 ~ 5.5V		CH1 : 4.75 ~ 5.5V	
	VOLTAGE TOLERANCE Note.3	±2.0%		±6.0%	
	LINE REGULATION	±0.5%		±1.0%	
	LOAD REGULATION	±0.5%		±4.0%	
SETUP, RISE TIME	300ms, 50ms / 230VAC		800ms, 50ms / 115VAC at full load		
HOLD TIME (Typ.)	80ms/230VAC		10ms/115VAC at full load		
INPUT	VOLTAGE RANGE	85 ~ 264VAC		120 ~ 370VDC	
	FREQUENCY RANGE	47 ~ 63Hz			
	EFFICIENCY(Typ.)	73%		76%	
	AC CURRENT (Typ.)	2A/115VAC		1A/230VAC	
	INRUSH CURRENT (Typ.)	COLD START 20A/115VAC		40A/230VAC	
LEAKAGE CURRENT	<3.5mA / 240VAC				
PROTECTION	OVER LOAD	105 ~ 150% rated output power Protection type : Hiccup mode, recovers automatically after fault condition is removed.			
	OVER VOLTAGE	5V : 5.75 ~ 6.75V Protection type : Hiccup mode, recovers automatically after fault condition is removed.			
ENVIRONMENT	WORKING TEMP.	-10 ~ +60°C (Refer to output load derating curve)			
	WORKING HUMIDITY	20 ~ 90% RH non-condensing			
	STORAGE TEMP., HUMIDITY	-20 ~ +85°C, 10 ~ 95% RH			
	TEMP. COEFFICIENT	±0.03%/°C (0 ~ 50°C) on +5V output			
	VIBRATION	10 ~ 500Hz, 2G 10min./1cycle, period for 60min. each along X, Y, Z axes			
SAFETY & EMC (Note 4)	SAFETY STANDARDS	UL1012, UL60950, TUV EN60950 Approved			
	WITHSTAND VOLTAGE	I/P-O/P:3KVAC I/P-FG:1.5KVAC O/P-FG:0.5KVAC			
	ISOLATION RESISTANCE	I/P-O/P, I/P-FG, O/P-FG:100M Ohms/500VDC			
	EMI CONDUCTION & RADIATION	Compliance to EN55022 (CISPR22) Class B			
	HARMONIC CURRENT	Compliance to EN61000-3-2,-3			
EMS IMMUNITY	Compliance to EN61000-4-2,3,4,5,6,8,11; ENV50204, EN55024, Light industry level, criteria A				
OTHERS	MTBF	301.2K hrs min. MIL-HDBK-217F (25°C)			
	DIMENSION	159*97*38mm (L*W*H)			
	PACKING	0.54Kg; 24pcs/13.8Kg/0.75CUFT			
NOTE	<p>1. All parameters NOT specially mentioned are measured at 230VAC input, rated load and 25°C of ambient temperature.</p> <p>2. Ripple & noise are measured at 20MHz of bandwidth by using a 12" twisted pair-wire terminated with a 0.1uf & 47uf parallel capacitor.</p> <p>3. Tolerance : includes set up tolerance, line regulation and load regulation.</p> <p>4. The power supply is considered a component which will be installed into a final equipment. The final equipment must be re-confirmed that it still meets EMC directives.</p>				



Astrodyne

60W Single Output Switching Power Supply

AD-60 series

Mechanical Specification

Case No. 901 Unit:mm

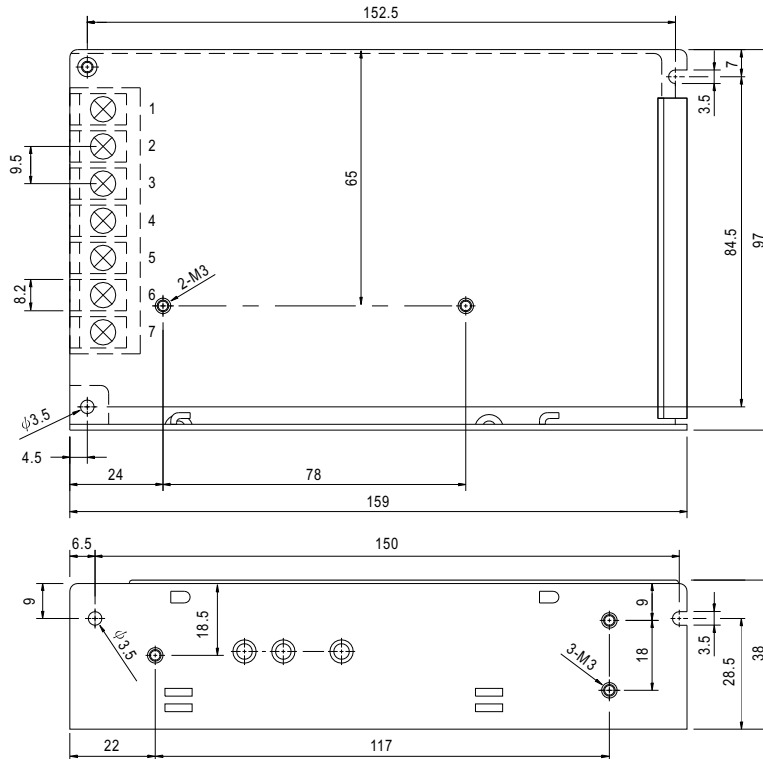

Terminal Pin. No Assignment

Pin No.	Assignment	Pin No.	Assignment
1	AC/L	4	DC OUTPUT +V2
2	AC/N	5	DC OUTPUT +V1
3	FG \perp	6,7	DC OUTPUT COM

Output Derating

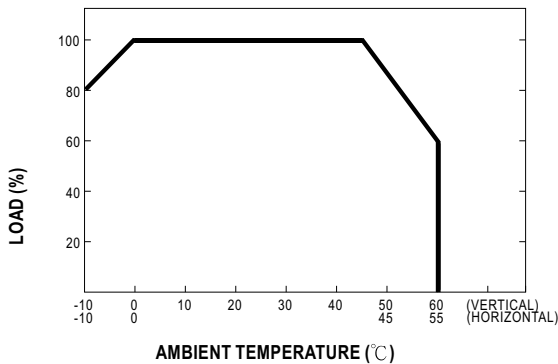

Static Characteristics (B)

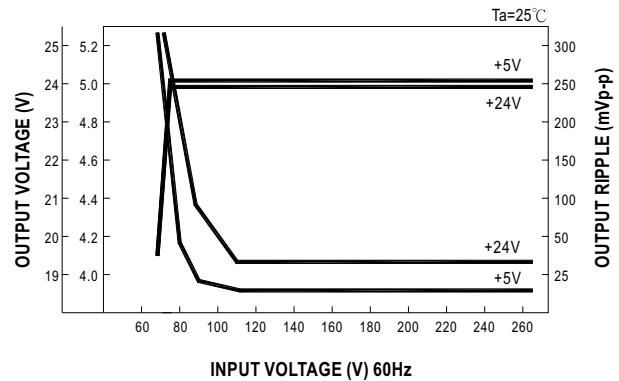



Astrodyne

60W Single Output Switching Power Supply

AT-60 series

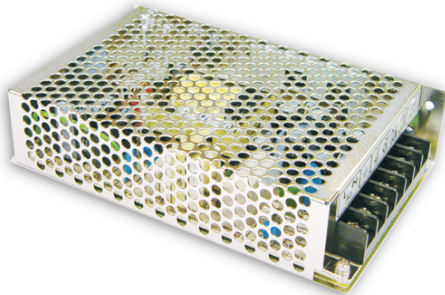

■ Features :

- Universal AC input / Full range
- Protections: Short circuit/Over load/Over voltage
- Cooling by free air convection
- LED indicator for power on
- Fixed switching frequency at 50KHz

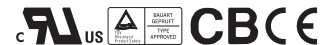

SPECIFICATION

MODEL		AT-60A			AT-60B			AT-60C		
OUTPUT	OUTPUT NUMBER	CH1	CH2	CH3	CH1	CH2	CH3	CH1	CH2	CH3
	DC VOLTAGE	5V	12V	-5V	5V	12V	-12V	5V	15V	-15V
	RATED CURRENT	5A	2.5A	0.5A	5A	2.5A	0.5A	5A	2A	0.5A
	CURRENT RANGE	0.5 ~ 7A	0.2 ~ 3.5A	0 ~ 1A	0.5 ~ 7A	0.2 ~ 3.5A	0 ~ 1A	0.5 ~ 7A	0.2 ~ 3A	0 ~ 1A
	RATED POWER	57.5W			61W			62.5W		
	RIPPLE & NOISE (max.) Note.2	100mVp-p	100mVp-p	100mVp-p	100mVp-p	100mVp-p	100mVp-p	100mVp-p	100mVp-p	100mVp-p
	VOLTAGE ADJ. RANGE	CH1 : 4.75 ~ 5.5V			CH1 : 4.75 ~ 5.5V			CH1 : 4.75 ~ 5.5V		
	VOLTAGE TOLERANCE Note.3	±2.0%	±6.0%	±6.0%	±2.0%	±6.0%	±6.0%	±2.0%	±6.0%	±6.0%
	LINE REGULATION	±0.5%	±1.0%	±0.5%	±0.5%	±1.0%	±0.5%	±0.5%	±1.0%	±0.5%
	LOAD REGULATION	±1.0%	±4.0%	±1.0%	±1.0%	±4.0%	±1.0%	±1.0%	±4.0%	±1.0%
	SETUP, RISE TIME	300ms, 50ms/230VAC			800ms, 50ms/115VAC at full load					
HOLD TIME (Typ.)	80ms/230VAC			10ms/115VAC at full load						
INPUT	VOLTAGE RANGE	85 ~ 264VAC		120 ~ 370VDC						
	FREQUENCY RANGE	47 ~ 63Hz								
	EFFICIENCY (Typ.)	72%			72%			72%		
	AC CURRENT (Typ.)	2A/115VAC		1A/230VAC						
	INRUSH CURRENT (Typ.)	COLD START 20A/115VAC		40A/230VAC						
LEAKAGE CURRENT	<3.5mA / 240VAC									
PROTECTION	OVER LOAD	105 ~ 150% rated output power Protection type : Hiccup mode, recovers automatically after fault condition is removed								
	OVER VOLTAGE	5V: 5.75 ~ 6.75V Protection type : Hiccup mode, recovers automatically after fault condition is removed								
ENVIRONMENT	WORKING TEMP.	-10 ~ +60°C (Refer to output load derating curve)								
	WORKING HUMIDITY	20 ~ 90% RH non-condensing								
	STORAGE TEMP., HUMIDITY	-20 ~ +85°C, 10 ~ 95% RH								
	TEMP. COEFFICIENT	±0.03%/°C (0 ~ 50°C) on +5V output								
VIBRATION	10~500Hz, 2G 10min./1cycle, period for 60min. each along X, Y, Z axes									
SAFETY & EMC (Note 4)	SAFETY STANDARDS	UL1012, UL60950, TUV EN60950 Approved								
	WITHSTAND VOLTAGE	I/P-O/P:3KVAC		I/P-FG:1.5KVAC		O/P-FG:0.5KVAC				
	ISOLATION RESISTANCE	I/P-O/P, I/P-FG, O/P-FG:100M Ohms/500VDC								
	EMI CONDUCTION & RADIATION	Compliance to EN55022 (CISPR22) Class B								
	HARMONIC CURRENT	Compliance to EN61000-3-2,-3								
EMS IMMUNITY	Compliance to EN61000-4-2,3,4,5,6,8,11; ENV50204, EN55024, Light industry level, criteria A									
OTHERS	MTBF	281.1K hrs min. MIL-HDBK-217F (25°C)								
	DIMENSION	159*97*38mm (L*W*H)								
	PACKING	0.55Kg; 24pcs/14.1Kg/0.75CUFT								
NOTE	1. All parameters NOT specially mentioned are measured at 230VAC input, rated load and 25°C of ambient temperature. 2. Ripple & noise are measured at 20MHz of bandwidth by using a 12" twisted pair-wire terminated with a 0.1uF & 47uF parallel capacitor. 3. Tolerance : includes set up tolerance, line regulation and load regulation. 4. The power supply is considered a component which will be installed into a final equipment. The final equipment must be re-confirmed that it still meets EMC directives.									



Astrodyne

60W Single Output Switching Power Supply

AT-60 series

Mechanical Specification

Case No. 901 Unit:mm

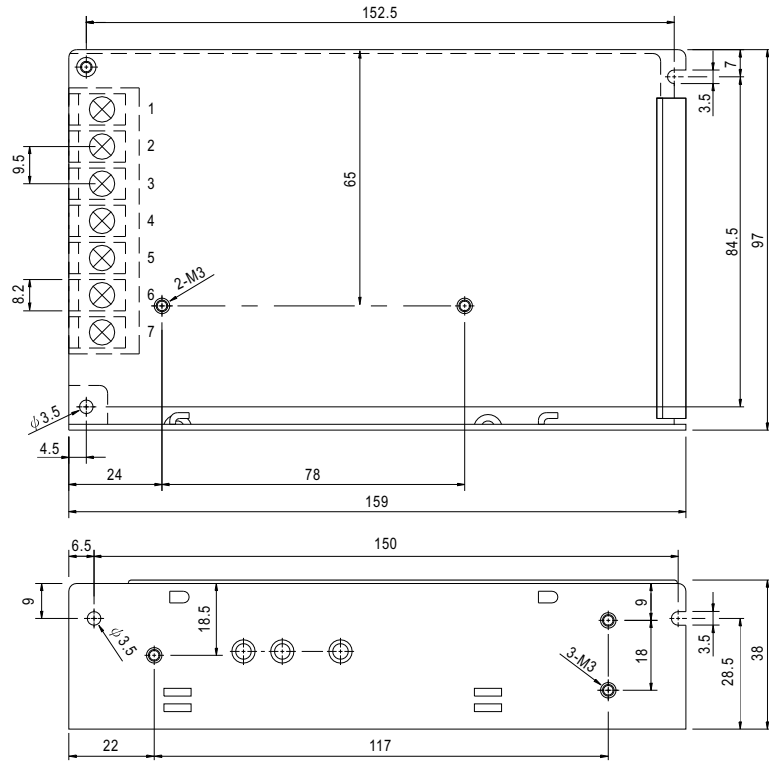

Terminal Pin. No Assignment

Pin No.	Assignment	Pin No.	Assignment	Pin No.	Assignment
1	AC/L	4	DC OUTPUT -V	7	DC OUTPUT +V1
2	AC/N	5	DC OUTPUT +V2		
3	FG \perp	6	DC OUTPUT COM		

Output Derating

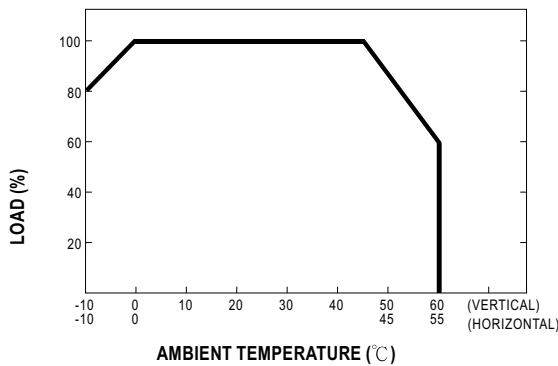

Static Characteristics (B)

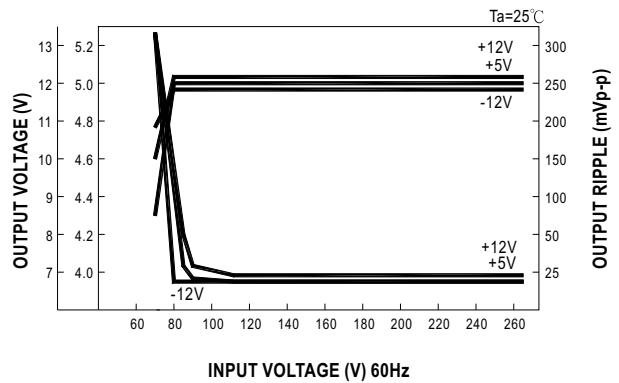



Astrodyne

60W Single Output Switching Power Supply

AQ-60 series



■ Features :

- Universal AC input / Full range
- Protections: Short circuit/Over load/Over voltage
- Cooling by free air convection
- LED indicator for power on
- Fixed switching frequency at 35KHz



SPECIFICATION

MODEL	AQ-60B				AQ-60C				AQ-60D				
OUTPUT	DC VOLTAGE	5V	12V	-5V	-12V	5V	15V	-5V	-15V	5V	12V	24V	-12V
	RATED CURRENT	5.5A	2A	0.5A	0.5A	5.5A	1.5A	0.5A	0.5A	4A	1A	1A	0.5A
	CURRENT RANGE	0.5 ~ 8A	0.1 ~ 3A	0 ~ 1A	0 ~ 1A	0.5 ~ 8A	0.1 ~ 3A	0 ~ 1A	0 ~ 1A	0.5 ~ 8A	0.1 ~ 3A	0.1 ~ 1.5A	0 ~ 1A
	RATED POWER	60W				60W				62W			
	RIPPLE & NOISE (max.) Note.2	100mVp-p	120mVp-p	100mVp-p	120mVp-p	100mVp-p	120mVp-p	100mVp-p	120mVp-p	100mVp-p	120mVp-p	100mVp-p	120mVp-p
	VOLTAGE ADJ. RANGE	CH1: 4.75 ~ 5.5V				CH1: 4.75 ~ 5.5V				CH1: 4.75 ~ 5.5V			
	VOLTAGE TOLERANCE Note.3	±2.0%	±6.0%	±5.0%	±5.0%	±2.0%	+8,-4%	±5.0%	±5.0%	±2.0%	±6.0%	+8,-4%	±5.0%
	LINE REGULATION	±0.5%	±1.0%	±0.5%	±0.5%	±0.5%	±2.0%	±0.5%	±0.5%	±0.5%	±1.0%	±2.0%	±0.5%
	LOAD REGULATION	±0.5%	±4.0%	±1.0%	±1.0%	±0.5%	±4.0%	±1.0%	±1.0%	±0.5%	±4.0%	±4.0%	±1.0%
SETUP, RISE, HOLD TIME	800ms, 20ms, 60ms/230VAC				1600ms, 20ms, 12ms/115VAC at full load								
INPUT	VOLTAGE RANGE	85 ~ 264VAC		120 ~ 370VDC									
	FREQUENCY RANGE	47 ~ 63Hz											
	EFFICIENCY (Typ.)	70%				72%				75%			
	AC CURRENT	2A/115VAC		0.8A/230VAC									
	INRUSH CURRENT (max.)	COLD START 18A/115VAC				36A/230VAC							
	LEAKAGE CURRENT	<1mA / 240VAC											
PROTECTION	OVER LOAD	105 ~ 150%/115VAC rated output power Protection type : Hiccup mode, recovers automatically after fault condition is removed											
	OVER VOLTAGE	5V: 5.75 ~ 6.75VDC Protection type : Hiccup mode, recovers automatically after fault condition is removed											
ENVIRONMENT	WORKING TEMP.	-10 ~ +60°C (Refer to output load derating curve)											
	WORKING HUMIDITY	20 ~ 90% RH non-condensing											
	STORAGE TEMP., HUMIDITY	-20 ~ +85°C, 10 ~ 95% RH											
	TEMP. COEFFICIENT	±0.03%/°C (0 ~ 50°C) on +5V output											
	VIBRATION	10 ~ 500Hz, 2G 10min./1cycle, 60min. each along X, Y, Z axes											
SAFETY & EMC (Note 4)	SAFETY STANDARDS	UL60950 Approved											
	WITHSTAND VOLTAGE	I/P-O/P:3KVAC I/P-FG:1.5KVAC O/P-FG:0.5KVAC											
	ISOLATION RESISTANCE	I/P-O/P, I/P-FG, O/P-FG:100M Ohms/500VDC											
	EMI CONDUCTION & RADIATION	Compliance to EN55022 (CISPR22) Class B											
OTHERS	HARMONIC CURRENT	Compliance to EN61000-3-2,-3											
	EMS IMMUNITY	Compliance to EN61000-4-2,3,4,5,6,8,11; ENV50204, Light industry level, criteria A											
NOTE	MTBF	284.8K hrs min. MIL-HDBK-217F (25°C)											
	DIMENSION	159*97*38mm (L*W*H)											
	PACKING	0.56Kg; 24pcs/14.4Kg/0.75CUFT											

Mechanical Specification

Case No. 901 Unit:mm

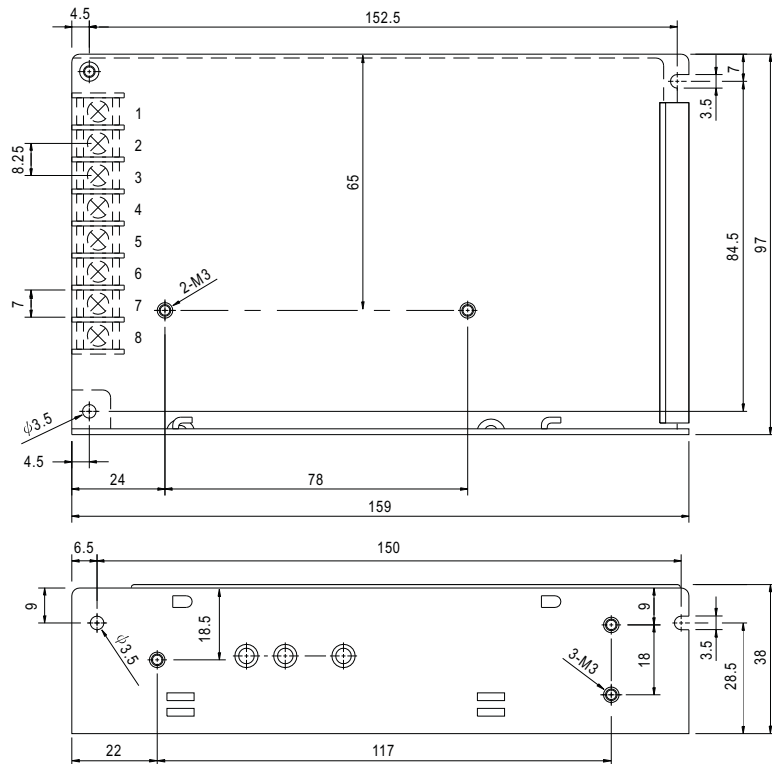

Terminal Pin. No Assignment

Pin No.	Assignment	Pin No.	Assignment	Pin No.	Assignment
1	AC/L	4	DC OUTPUT -V1	7	DC OUTPUT COM
2	AC/N	5	DC OUTPUT -V2	8	DC OUTPUT +V1
3	FG \perp	6	DC OUTPUT +V2		

Derating Curve

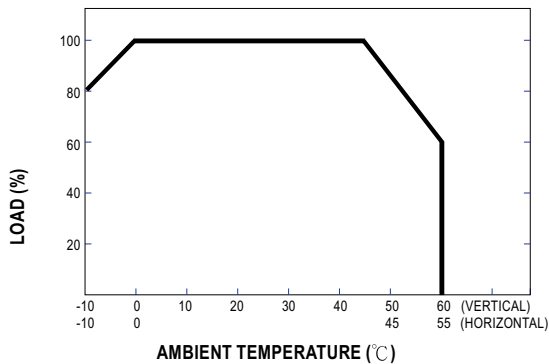

Static Characteristics

