

### LC512NWH1-25H

#### Features

- 5mm Package
- High Optical Power
- Low Current Requirement
- Water Clear Lens
- High Luminous Intensity



### ATTENTION

OBSERVE PRECAUTIONS  
ELECTROSTATIC  
SENSITIVE DEVICES

#### Maximum Ratings (Ta=25°C)

Characteristic	Symbol	Max.	Unit
Forward Current	I <sub>F</sub>	25	mA
Reverse Voltage	V <sub>R</sub>	5.00	V
Power Dissipation	P <sub>D</sub>	120.00	mW
Operating Temperature	T <sub>opr</sub>	-20 ~ +75	°C
Storage Temperature	T <sub>stg</sub>	-30 ~ +80	°C
Soldering Temperature	T <sub>sol</sub>	260	°C
Soldering Time	-	for 3 sec. max	-

#### Opto-Electrical Characteristics (Ta=25°C)

Characteristic	Symbol	Test Condition	Min	Typ	Max	Unit
Forward Voltage	V <sub>F</sub>	I <sub>F</sub> =20mA	3.20	3.60	4.20	V
Reverse Current	I <sub>R</sub>	V <sub>R</sub> =5V	-	-	100	μA
Luminous Intensity	I <sub>v</sub>	I <sub>F</sub> =20mA	550.00	1400.00	-	mcd
Viewing Angle	2θ <sup>1/2</sup>	-	-	25°	-	deg.
Peak Wavelength	λ <sub>p</sub>	I <sub>F</sub> =20mA	-	465	-	nm
Dominant Wavelength	λ <sub>d</sub>	I <sub>F</sub> =20mA	-	x=.31, y=.32	-	nm
Spectral Line Half Width	Δλ	I <sub>F</sub> =20mA	-	28	-	nm

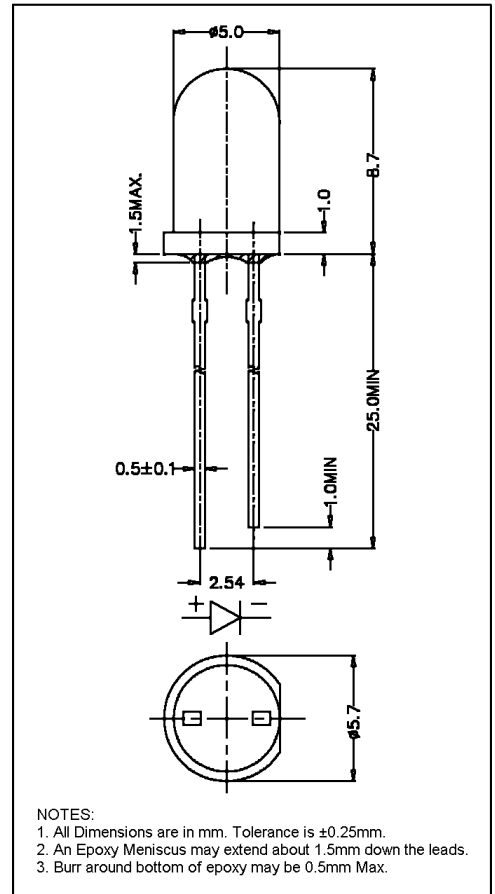

**Company Headquarters**  
3 Northway Lane North  
Latham, New York 12110  
Toll Free: 800.984.5337  
Fax: 518.785.4725



Web: [www.marktechopto.com](http://www.marktechopto.com) | Email: [info@marktechopto.com](mailto:info@marktechopto.com)

**California Sales Office:**  
950 South Coast Drive, Suite 225  
Costa Mesa, California 92626  
Toll Free: 800.984.5337  
Fax: 714.850.9314

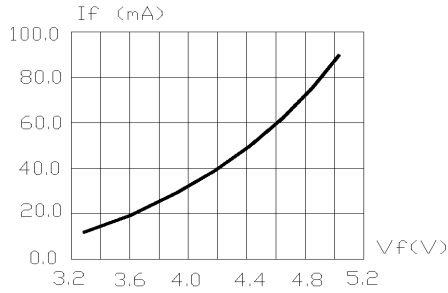

FIG.1 FORWARD CURRENT VS. FORWARD VOLTAGE.

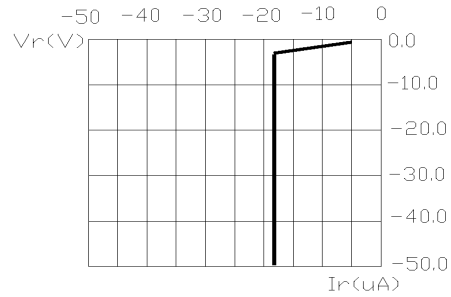

FIG.2 REVERSE CURRENT VS. REVERSE VOLTAGE.

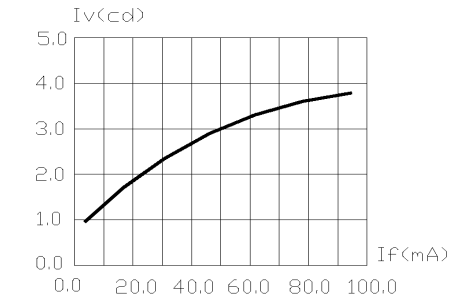

FIG.3 RELATIVE LUMINOUS INTENSITY VS. FORWARD CURRENT.

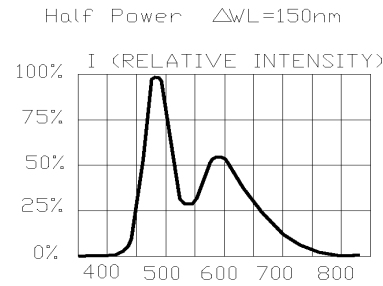

FIG.4 RELATIVE INTENSITY VS. WAVE LENGTH.

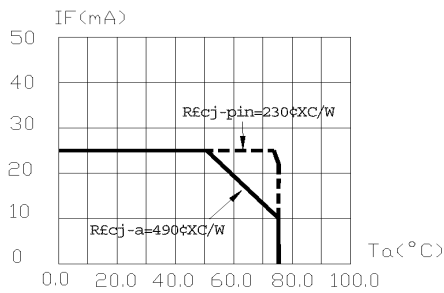

FIG.5 MAXIMUM FORWARD DC CURRENT VS AMBIENT TEMPERATURE . DERATING BASED ON  $T_{jmax}=95^{\circ}C$

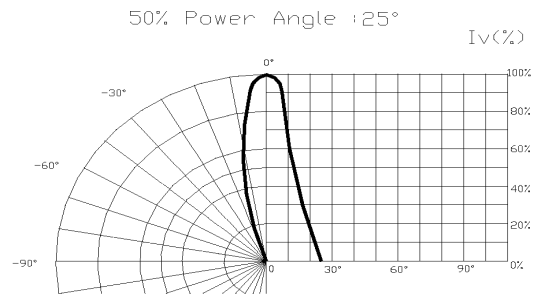
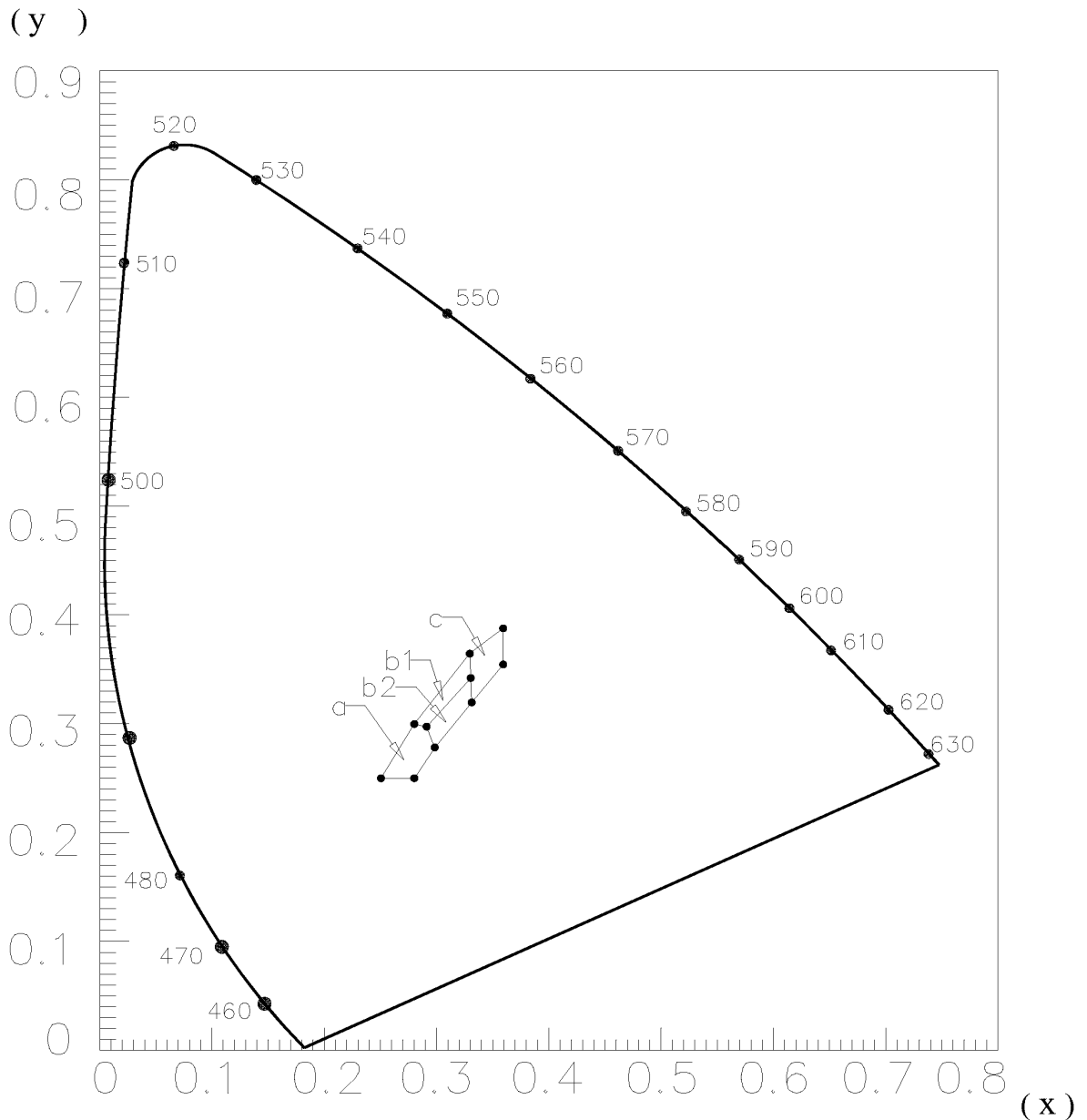

FIG.6 SPATIAL DISTRIBUTION.

1. Cathode PAD Area ( $0.18 \times 0.18 \text{ inch}^2$ )
2. Height above nominal seating plane in inches (0.3inch)

CIE Chromaticity Diagram



**Company Headquarters**  
 3 Northway Lane North  
 Latham, New York 12110  
 Toll Free: 800.984.5337  
 Fax: 518.785.4725



Web: [www.marktechopto.com](http://www.marktechopto.com) | Email: [info@marktechopto.com](mailto:info@marktechopto.com)

**California Sales Office:**  
 950 South Coast Drive, Suite 225  
 Costa Mesa, California 92626  
 Toll Free: 800.984.5337  
 Fax: 714.850.9314