

High Power LED - 1W

Features

- Feature of the device: Small package with high efficiency
- View angle: 130°C
- High luminous flux output: more than 65 lm@350mA
- ESD protection
- Soldering methods: Hot bar soldering
- Grouping parameter: Total luminous flux, dominant wavelength
- Optical efficiency: 49 lm/W
- Thermal resistance (junction to lead): 15 K/W
- RoHS Compliance



QSLGTRV



Applications

- TFT LCD display backlight
- Decorative and entertainment illumination
- Signal and symbol luminaries for orientation marker light (e.g. steps, exit ways, etc.)
- Exterior and interior automotive illumination

Materials

Items	Description
Housing	Heat resistant polymer
Encapsulating Resin	Clear silicone resin
Electrodes	Ag plating copper alloy
Die attach	Silver paste
Chip Emitted Color	Super Green
Chip	InGaN

Absolute Maximum Ratings ($T_a=25^{\circ}\text{C}$)

Parameter	Symbol	Value	Unit
Forward Current	I_F	500	mA
Junction to heat-sink thermal resistance	R_{th}	15	K/W
Power Dissipation	P_d	2.0	W
Junction Temperature	T_j	125	$^{\circ}\text{C}$
Operating Temperature	T_{opr}	-40 ~ +100	$^{\circ}\text{C}$
Storage Temperature	T_{stg}	-40 ~ +100	$^{\circ}\text{C}$

Electro-Optical Characteristics ($T_a=25^{\circ}\text{C}$)

Parameter	Bin	Symbol	Min.	Typ.	Max.	Unit	Condition
Luminous Flux (1)	J5	θ_v	45	-----	52	lm	IF =350mA
	K1		52	-----	60		
	K2		60	-----	70		
Viewing Angle (2)	-----	$2\theta_{1/2}$	-----	130	-----	deg	
Forward Voltage	-----	VF	-----	3.3	4.0	V	
Wavelength(3)	C6	λ_d	515	-----	520	nm	
	G1		520	-----	525		
	G2		525	-----	530		
	G3		530	-----	535		

Notes:

1. Luminous flux measurement tolerance: $\pm 10\%$
2. $2\theta_{1/2}$ is the off axis angle from lamp centerline where the luminous intensity is $\frac{1}{2}$ of the peak value.
3. Wavelength measurement tolerance : $\pm 1\text{nm}$

Typical Electro-Optical Characteristics Curves

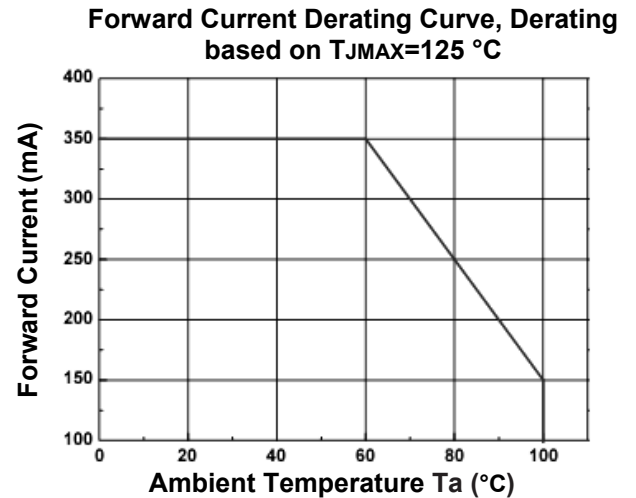
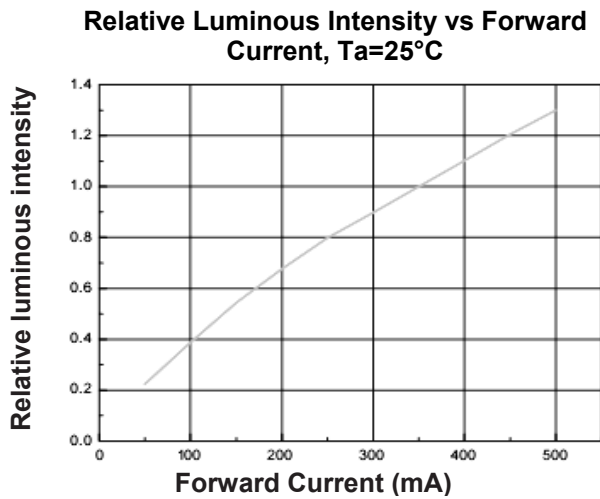
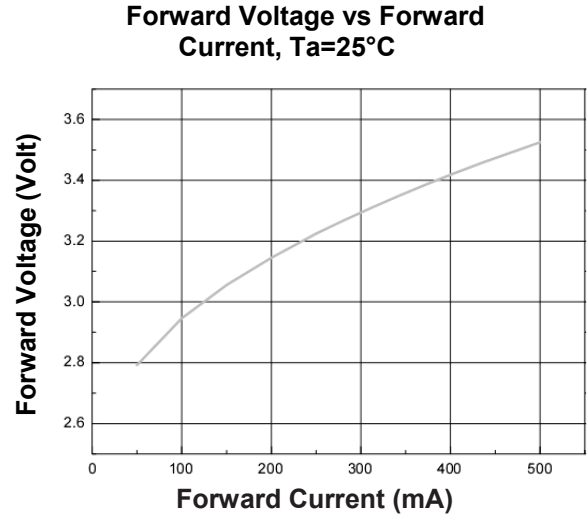
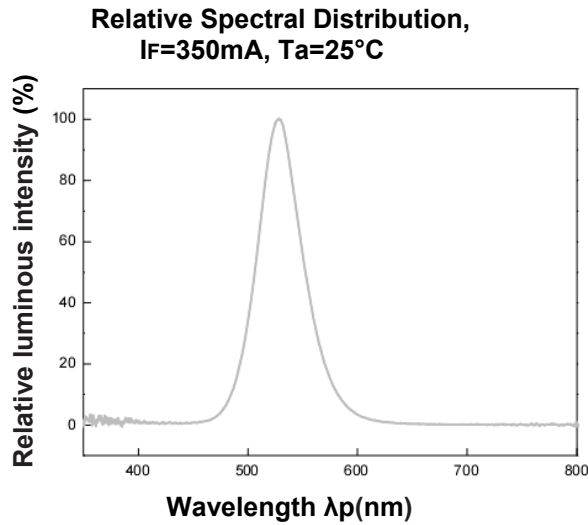

Typical Representative Spatial Radiation Pattern

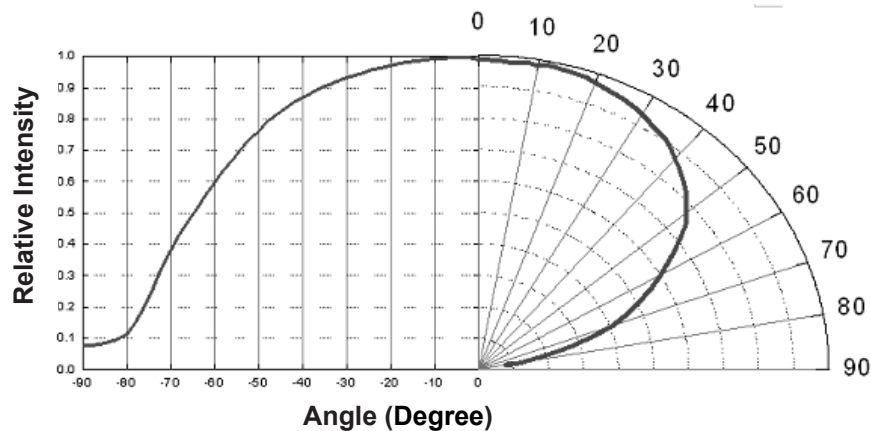

Reliability Test Items and Conditions

No.	Items	Test Condition	Test Hours / Cycles	Sample Size	Ac/Re
1	Solderability	Tsol=230°C, 5sec	1 times	22 PCS	0/1
2	Resistance to Solder Heat	Tsol =260°C, 10sec, 6 Min	3 times	22 PCS	0/1
3	Temperature Cycle	H: +100°C 30min ┆ 5 min L: - 40°C 30min	1000 Cycles	22 PCS	0/1
4	Thermal Shock	H: +110°C 20min ┆ 10 sec L: - 40°C 20min	500 Cycles	22 PCS	0/1
5	High Temperature Storage	Temp: 110°C	1000 Hrs.	22 PCS	0/1
6	Low Temperature Storage	Temp: - 40°C	1000 Hrs.	22 PCS	0/1
7	High Temperature Operation Life #1	Ta=55°C IF=350mA	1000 Hrs.	22 PCS	0/1
8	High Temperature Operation Life #2	Ta=85°C IF=225mA	1000 Hrs.	22 PCS	0/1
9	High Temperature Operation Life #3	Ta=100°C IF=150mA	1000 Hrs.	22 PCS	0/1
10	Low Temperature Operation Life	Ta= - 40°C IF=350mA	1000 Hrs.	22 PCS	0/1
11	Power Temperature Cycle	H: +85°C 15min ┆ 5 min L: - 40°C 15min IF=225mA, 2min on/off	1000 cycles	22 PCS	0/1
12	High Temperature / High Humidity Reverse Bias	85°C / 85%RH	1000 Hrs.	22 PCS	0/1
13	Intermittent operational Life	Ta=25°C , IF=1000mA 30mS on/ 2500mS off	1000 Hrs.	22 PCS	0/1
14	ESD Human Body Model	2000V, Interval: 0.5sec	3 times	22 PCS	0/1
15	ESD Machine Model	200V, Interval: 0.5sec	3 times	22 PCS	0/1

Notes:

Im: Brightness Attenuate Difference (1000hrs) <50%

VF: Forward Voltage Difference < 20%

Package Dimensions (In mm)

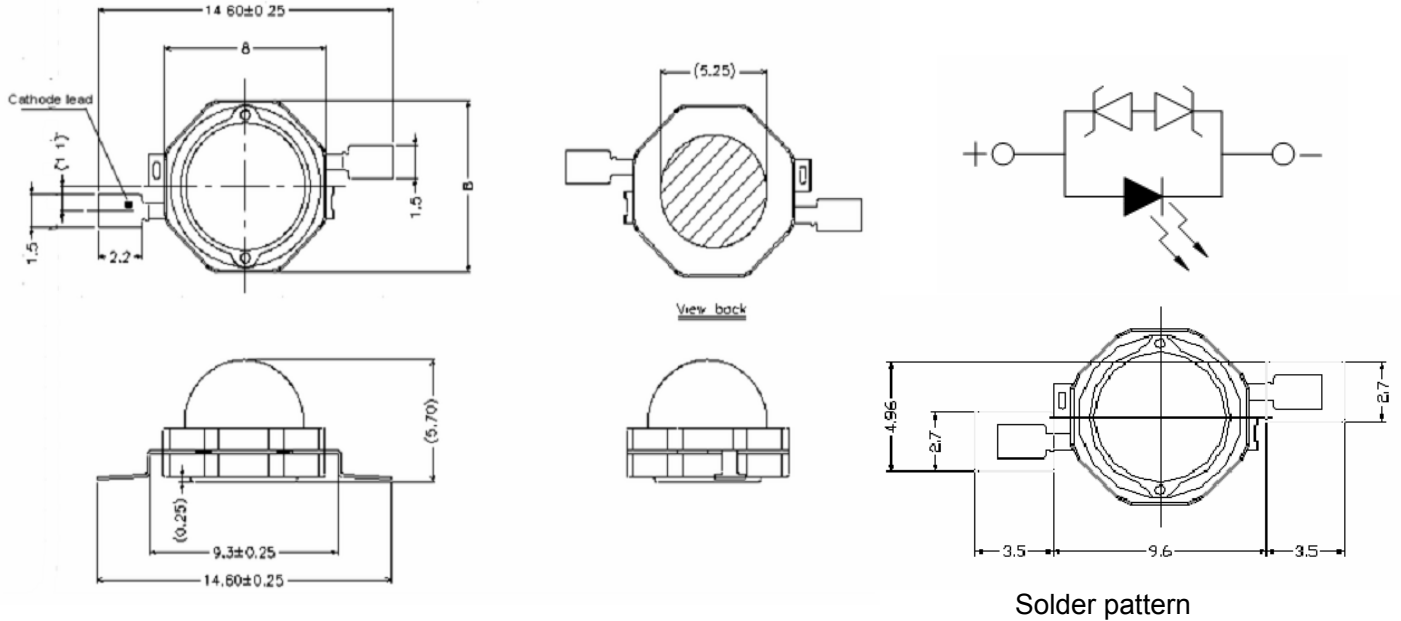

- Note:** 1. Dimensions are in millimeters
2. Tolerances unless dimensions ± 0.25 mm

Carrier Tape Dimensions: Loaded quantity 800pcs per reel

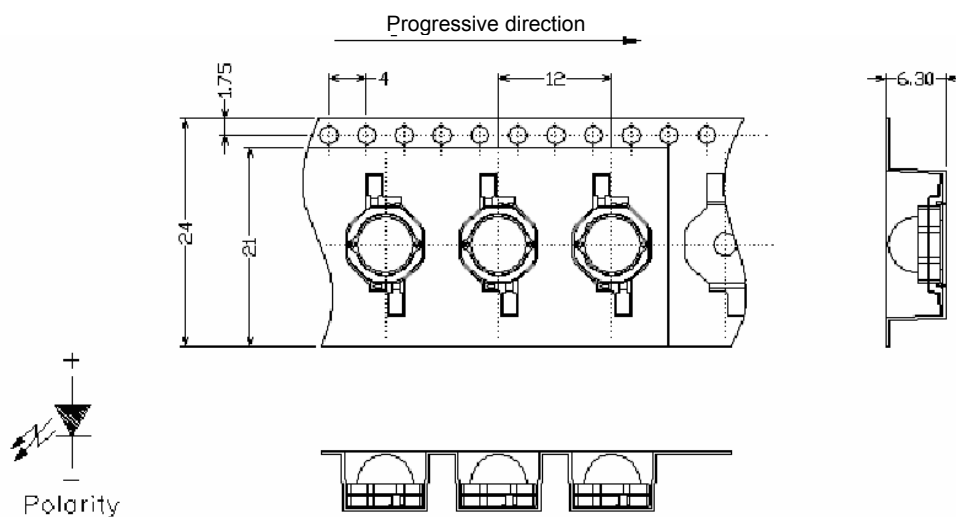

- Note:** 1. Dimensions are in millimeters
2. Tolerances unless dimensions ± 0.1 mm

Reel Dimensions:

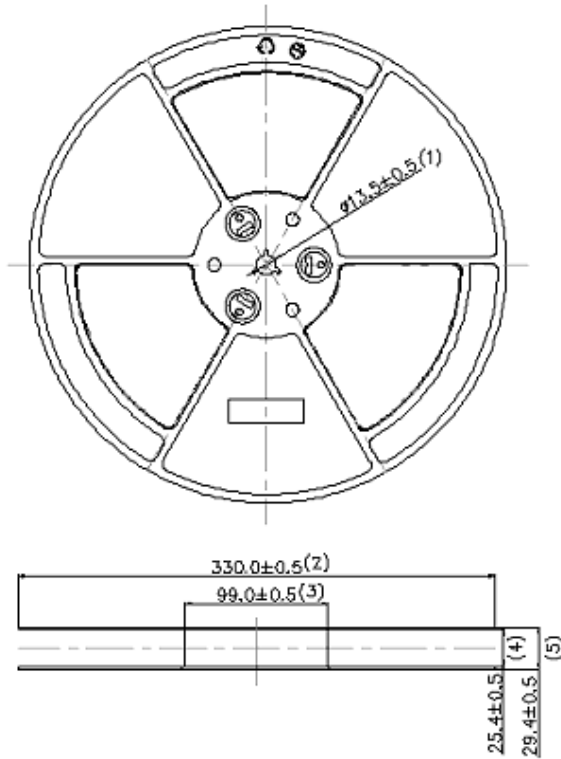

Note: The tolerances unless mentioned is ± 0.1 mm

Moisture Resistant Packaging:

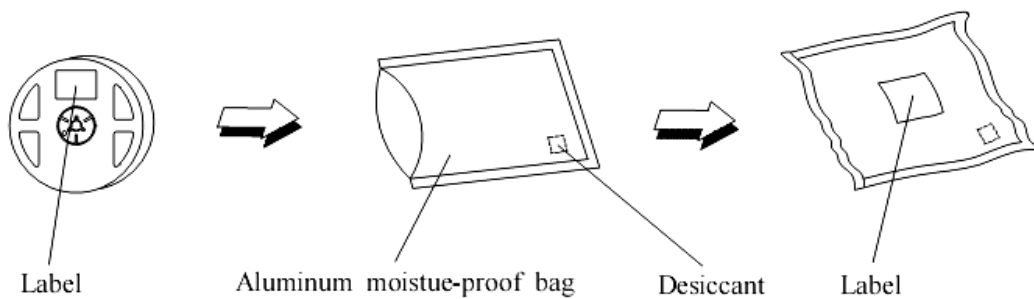

Ordering Information

T S L G - T R 8080 - A08L-92-TR70

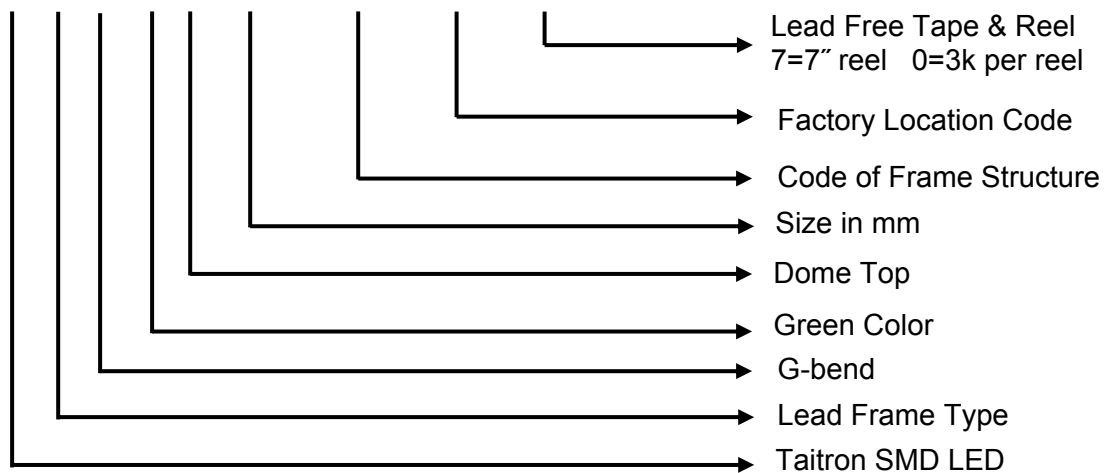

Precautions For Use

1. Over-current-proof

Though the LEDs have conducted ESD protection mechanism, customer must not use the device in reverse and should apply resistors for extra protection. Otherwise slight voltage shift may cause enormous current change and burn out failure would happen.

2. Storage

Do not open moisture proof bag before the products are ready to use.

Before opening the package, the LEDs should be kept at 30°C or less and 90%RH or less.

The LEDs should be used within a year.

After opening the package, the LEDs should be kept at 30°C or less and 70%RH or less.

The LEDs should be used within 168 hours (7 days) after opening the package.

If the moisture absorbent material (silicone gel) has faded away or the LEDs have exceeded the storage time, baking treatment should be performed using the following conditions.

Pre-curing treatment: 60±5°C for 24 hours.

3. Thermal Management

For maintaining the high flux output and achieving reliability, the series LED package should be mounted on a metal core printed circuit board (MCPCB) with proper thermal connection to dissipate approximately 1W of thermal energy under 350mA operation.

MCPCB structure



Recommended supplier:

- Kavano Industrial Co., Ltd
- TT Electronics

Special thermal designs are also recommended to take in outer heat sink design, such as FR4 PCB on Aluminum with thermal vias or FPC on Aluminum with thermal conductive adhesive, etc. Sufficient thermal management must be conducted, or the die junction temperature will be over the limit under large electronic driving and LED lifetime will decrease critically.

4. Assembly process flow



Thermal conductive glue dispensing
Recommended material and its supplier: EpoTek T7109 from Epoxy Technology



LED emitter placement

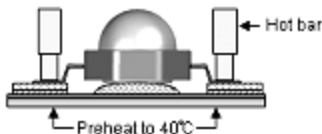

Hot bar soldering of LED emitter
Note: The MCPCB should be preheated up to 40°C for increasing the solderability

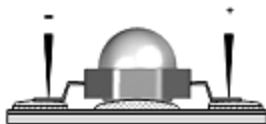

Functional test of LED emitter

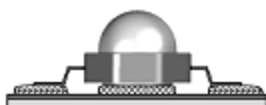

Curing of thermal conductive glue

Handling Indications: Do not handle the LEDs by the lens at any time during the assembly process. This can cause damage to the optical surfaces or may dislocate the lens if excessive force is applied.

5. Soldering Iron

For prototype builds or small series production runs it is possible to place and solder the LED by hand.

Dispensing thermal conductive glue or grease on the substrates and follow its curing spec. Press LED housing to closely connect LED and substrate.

It is recommended to hand solder the leads with a solder tip temperature of 280°C for less than 3 seconds within once in less than the soldering iron capacity 25W. Leave two seconds and more intervals, and do soldering of each terminal.

Be careful because the damage of the product is often started at the time of the hand solder.

How to contact us

US HEADQUARTERS

28040 WEST HARRISON PARKWAY, VALENCIA, CA 91355-4162

Tel: (800) TAITRON (800) 247-2232 (661) 257-6060

Fax: (800) TAITFAX (800) 824-8329 (661) 257-6415

Email: taitron@taitroncomponents.com

Http://www.taitroncomponents.com

TAITRON COMPONENTS MEXICO, S.A .DE C.V.

BOULEVARD CENTRAL 5000 INTERIOR 5 PARQUE INDUSTRIAL ATITALAQUIA, HIDALGO

C.P. 42970 MEXICO

Tel: +52-55-5560-1519

Fax: +52-55-5560-2190

TAITRON COMPONETS INCORPORATED E REPRESENTAÇÕES DO BRASIL LTDA

RUA DOMINGOS DE MORAIS, 2777, 2.ANDAR, SALA 24 SAÚDE - SÃO PAULO-SP 04035-001

BRAZIL

Tel: +55-11-5574-7949

Fax: +55-11-5572-0052

TAITRON COMPONETS INCORPORATED, SHANGHAI REPRESENTATIVE OFFICE

CROSS REGION PLAZA, 899 LINGLING ROAD, SUITE 18C, SHANGHAI, 200030, CHINA

Tel: +86-21-54249942

Fax: +86-21-5424-9931