

**TBL-1005-245-M2 THIN FILM BALUN**

1. Feature

- 1-1 2.45GHz Thin Film Balun.
- 1-2 For ISM Band applications like Bluetooth/WLAN.
- 1-3 Ultra Low Profile
- 1-4 Lead Free, RoHS compliance

2. Part Number

TBL — 1005 — 245 — M2 — XX  
 (1) (2) (3) (4) (5)

- Where
- (1) TBL : Thin Film Balun
  - (2) Size :  
4 digits of number —1005 = 1.0×0.5 mm
  - (3) Center Frequency :  
245 = 2.45 GHz
  - (4) Type  
Refer to Table 3-1
  - (5) XX  
Internal Code

3. Ratings

3-1 Specifications

Part Number	TBL-1005-245-M2
Unbalance Port Impedance	50 Ω
Balance Port Impedance	100 Ω
Nominal Center Frequency	2450MHz
Bandwidth	2400 ~ 2500MHz
Phase Balance	180 ± 10°
Amplitude Balance	0 ± 2.0dB max.
Insertion Loss	1.2dB Max at 25°C
VSWR at Unbalance Port in BW	2.0 Max.
Power Capacity	500mW Max.

3-2 Operation Temperature: -40°C to +85°C

3-3 Storage Temperature: -40°C to +85°C

### 4. Outline Dimension

#### TopView

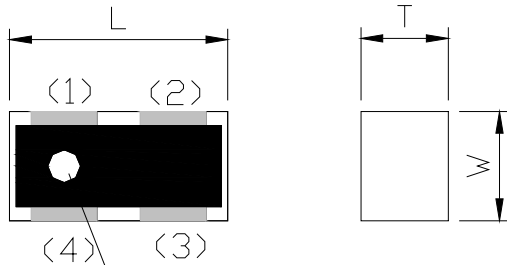

#### BackView

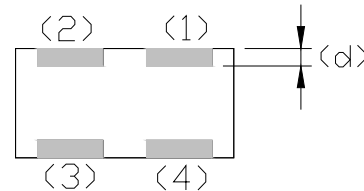

#### Directional Marking

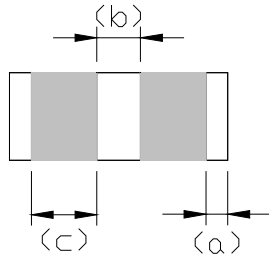

Code	Dimension(mm)	Code	Dimension(mm)
L	1.00±0.1	(a)	0.10±0.1
w	0.50±0.15	(b)	0.20±0.1
T	0.40±0.1	(c)	0.30±0.1
		(d)	0.125±0.1

#### Terminal Configuration

(1)	Balance Port
(2)	Balance Port
(3)	GND or DC feed + RF GND
(4)	Unbalance Port

### 5. Electrical Performance

#### Insertion Loss and Return Loss

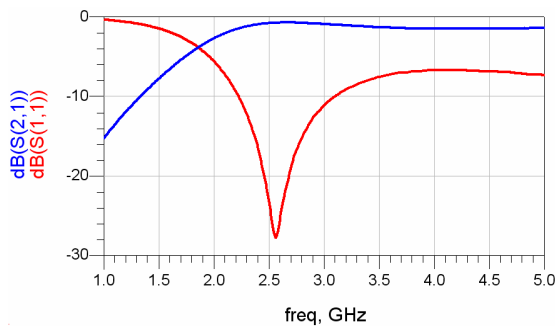

#### Amplitude Balance

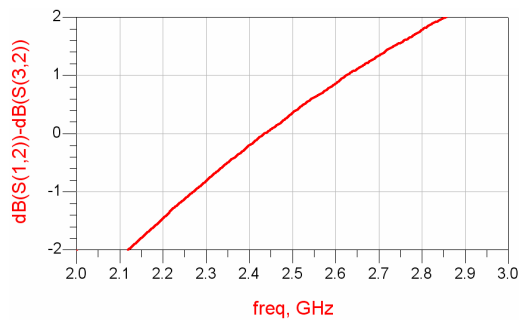

#### Phase Balance

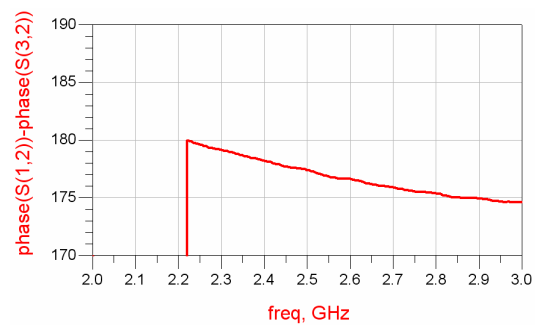

6. Measurement

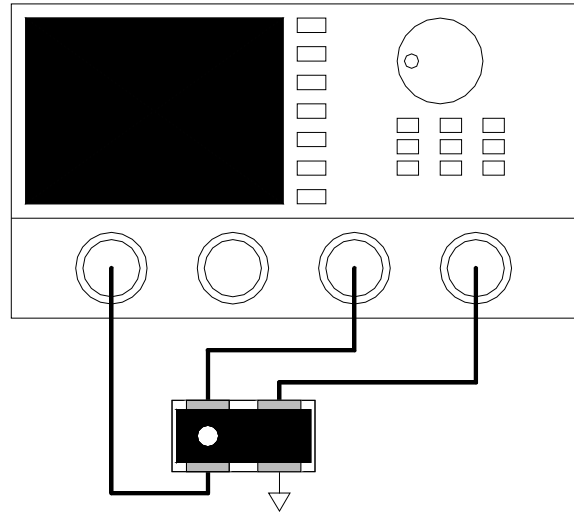

Network analyzer : Agilent PNA N5230A

7. Recommended Land Pattern

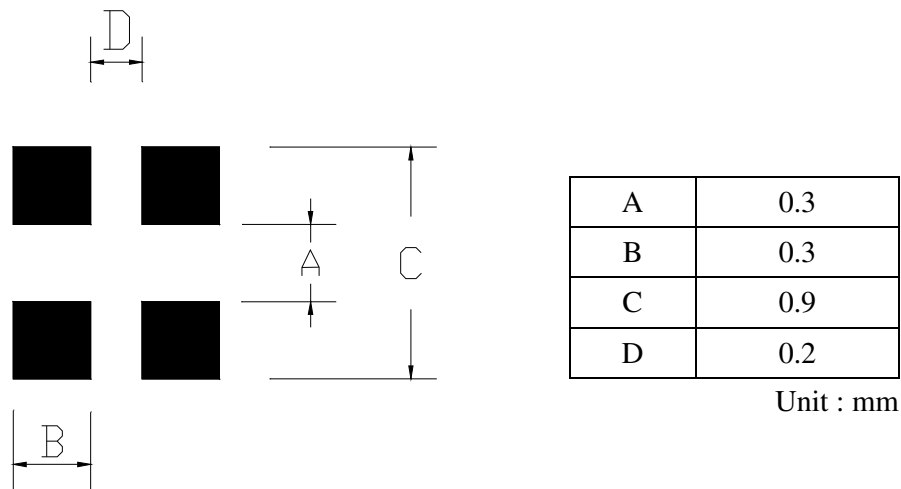

8. Reliability Test

8-1 Electrical

Item	Specification and Requirement	Test Method
Temperature Characteristics	Satisfy electrical characteristics	Solder the sample on PCB. Exposure at each temperature, -40°C, -20°C, 0°C, +25°C, +50°C, +85°C for 30minutes

8-2 Mechanical

Item	Specification and Requirement	Test Method
Solderability	The Surface of terminal immersed shall be minimum of 95% covered with a new coating of solder	Solder bath : After immersing in flux, dip in 245 ± 5°C molten solder bath for 2 ± 0.5 seconds
Resistance to solder Heat	Satisfy electrical characteristics without distinct deformation in appearance	(1) Pre-heat : 100 ~ 110°C for 30 seconds (2) Immersed at solder bath of 270 ± 5°C for 20 ± 1 seconds
Vibration	Satisfy electrical characteristics without Mechanical damage such as break	Vibrate as apply 20 to 2,000Hz, 186m/s <sup>2</sup> (19G) acceleration 1.5mm amplitude for 2 hours in each of three (X, Y, Z) axis (total 6 hours).
Shock	Satisfy electrical characteristics without mechanical damaged such as break	(1) Break value : 490 N (2) Duration of pulse : 11ms (3) 3 times in each positive and negative direction of 3 mutual perpendicular directions.
Bending Test	Satisfy electrical characteristics without mechanical damage such as break	Bending value : 3mm for 30 ± 1 seconds
Solvent Resistant	Marking should be legible without mechanical and distinct damage in appearance	(1) Solvent : Trichloroethane or Isopropyl alcohol. (2) Immersed in solvent at room temperature for 90 seconds
Drop Test	Satisfy electrical characteristics without mechanical damage	Drop the sample from a height of 1m to concrete ground for 10 times

8-3 Load Life

Item	Specification and Requirement	Test Method
Rapid change of temperature	Satisfy Electrical Characteristics. Without distinct damage.	Perform 5 cycles as follows : -55°C for 30minutes → room temperature for 3 minutes→ +125°C for 30minutes → room temperature for 3 minutes. (Dwell time : 5 to 8 minutes)
Humidity Resistance Test	Satisfy Electrical Characteristics. Without distinct damage.	Precondition at +25°C for 1hour. Let stand at temperature +40 ± 3°C, 90~95% relative humidity for 1,000 hours before taking final measurements.
Low Temperature Store	Satisfy Electrical Characteristics. Without distinct damage.	Solder the sample on PCB. Exposure at -55 ± 3°C for 1,000 hours. 1~2 hours exposure at room temperature and humidity, prior to measurement.
High Temperature Store	Satisfy Electrical Characteristics. Without distinct damage.	Solder the sample on PCB. Exposure at +85 ± 3°C for 1,000 hours. 1~2 hours exposure at room temperature and humidity, prior to measurement.

9. Packaging

9-1 Dimensions

9-1-1 Tape packaging dimensions

Cover Material : Polyethylene

Tape Packaging Dimensions

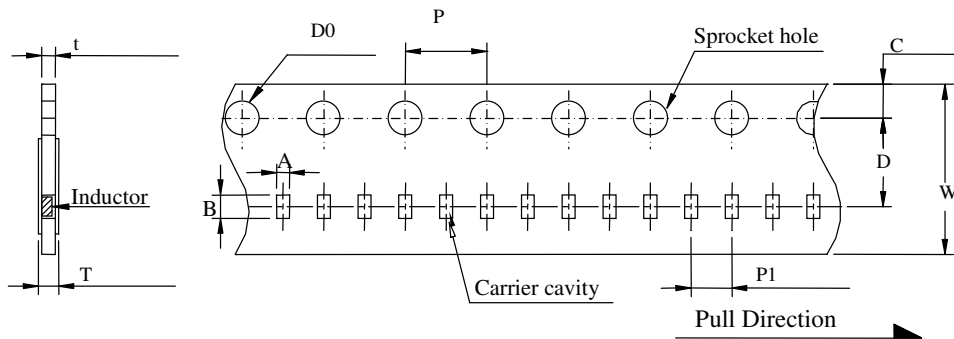

Code	Dimensions (mm)
A	$0.63 \pm 0.05$
B	$1.13 \pm 0.05$
C	$1.75 \pm 0.1$
D	$3.5 \pm 0.05$
W	$8.0 \pm 0.3$
P	$4.0 \pm 0.1$
P1	$2.0 \pm 0.05$
T	$0.48 \pm 0.1$
t	$0.42 \pm 0.05$
D0	$\phi 1.5 \begin{matrix} +0.1 \\ -0.0 \end{matrix}$

9-1-2 Setting Direction

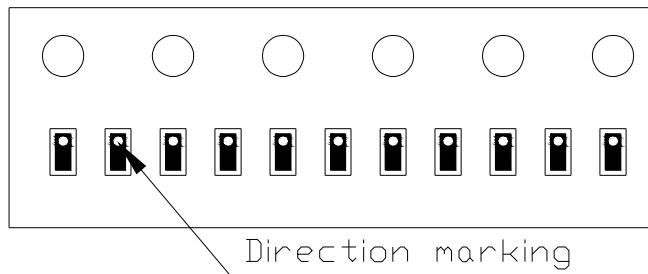

9-1-3 Reel dimensions( Material : Polystyrene )

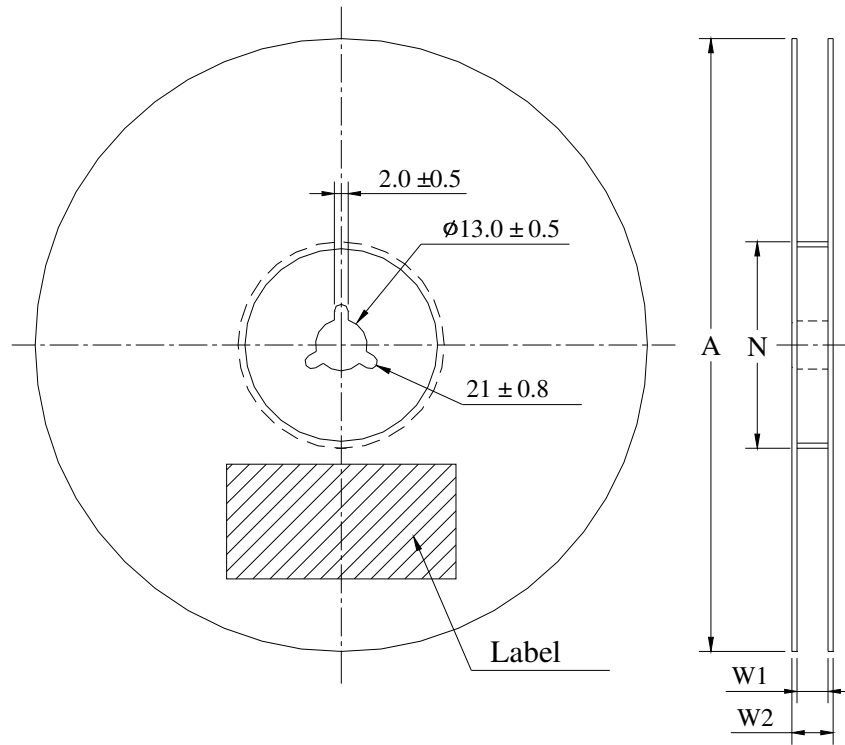

A	$\phi 178 \pm 2$
N	$\phi 60 \pm 2$
W1	$9.0 \pm 0.3$
W2	$11.4 \pm 1.0$

Unit : mm

9-2 Peel force of top cover tape

The peel speed shall be about 300 mm/minute

The peel force of top cover tape shall be between 10 to 70g

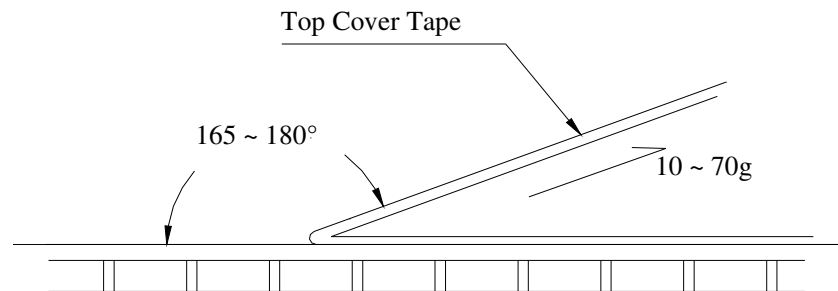

9-3 Numbers of taping

10,000 pieces/reel

9-4 Label marking

The following items shall be marked on the production and shipping Label on the reel.

9-4-1 Production Label

- (1) Part No.
- (2) Description
- (3) Quantity
- (4) Taping No.

9-4-2 Shipping Label

- (1) \*Customer's name
- (2) \*Customer's part No.
- (3) Manufacturer's part No.
- (4) Manufacturer's name
- (5) Manufacturer's country

\*Note : Item (1) and (2) are listed by request