

## SPECIFICATIONS

Electrical Ratings	50mA @ 48VDC
Electrical Life	100,000 cycles typical
Contact Resistance	< 50 mΩ initial
Actuation Force	160 +/- 50gF
Actuator Travel	.25 +/- .1mm
Dielectric Strength	1000Vrms min
Insulation Resistance	> 100MΩ min
Operating Temperature	-40°C to 85°C
Storage Temperature	-40°C to 85°C



## MATERIALS ←RoHS COMPLIANT

Actuator	4/6 Nylon
Housing	4/6 Nylon
Cover	Steel
Contacts	Phosphor Bronze, Silver Plated
Terminals	Brass, Silver Plated

## ORDERING INFORMATION

<b>1. Series:</b>	<b>CS1110A</b>	<b>3.1</b>
CS1110		
CS1110A w/ grounding tab		
CS1110J w/ J lead terminals		
CS1110M w/ mounting stems		
<b>2. Actuator Length "L" (mm):</b>		
2.0		
2.3		
2.5		
3.1		

## DIMENSIONS

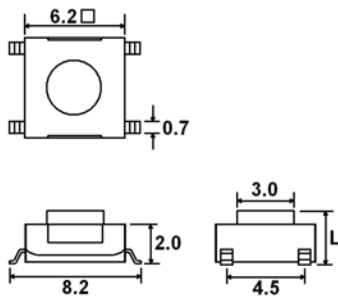

**CS1110**

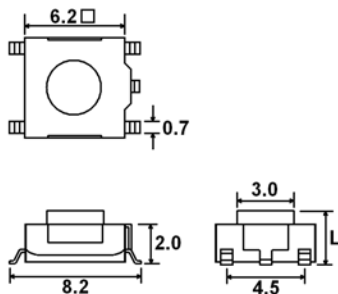

**CS1110A**

## SCHEMATIC & PC LAYOUT

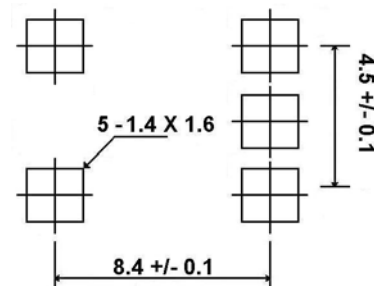
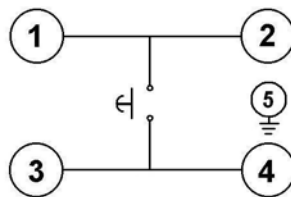
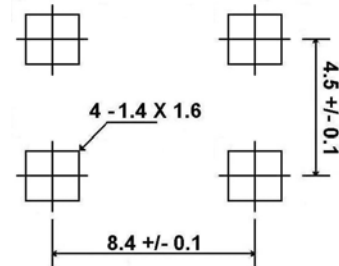
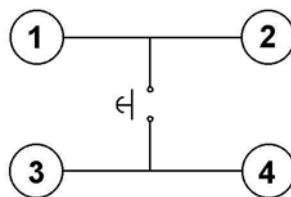

**DIMENSIONS**

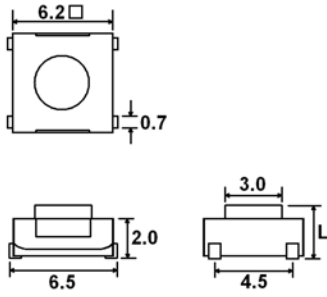

**CS1110J**

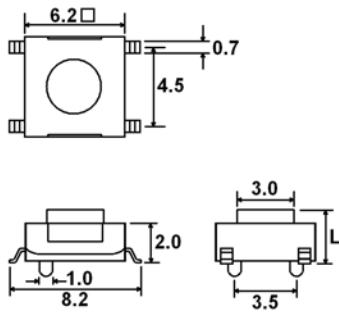

**CS1110M**

**SCHEMATIC & PC LAYOUT**

