

AC Line Filters Hybrid Choke Coils

PLY17 Series

PLY17 Series A Type

Dimension

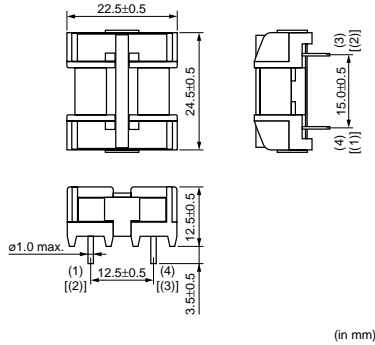

Common Mode Insertion Loss-Frequency Characteristics

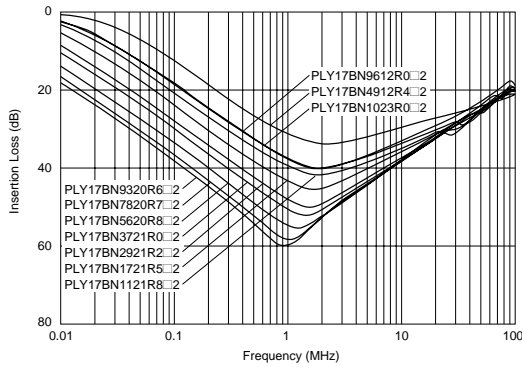

Differential Mode Insertion Loss-Frequency Characteristics

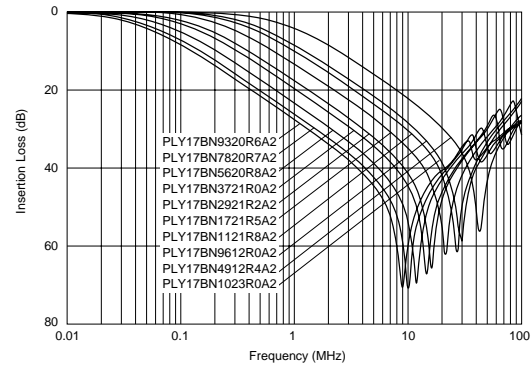

Rated Value (□: packaging code)

Part Number	Common Mode Inductance (min.)	Normal Mode Inductance (min.)	Rated Current	Rated Voltage
PLY17BN4912R4A2□	0.49mH	18μH	2.4A	300Vac
PLY17BN9612R0A2□	0.96mH	36μH	2.0A	300Vac
PLY17BN1023R0A2□	1.0mH	36μH	3.0A	300Vac
PLY17BN1121R8A2□	1.1mH	44μH	1.8A	300Vac
PLY17BN1721R5A2□	1.7mH	67μH	1.5A	300Vac
PLY17BN2921R2A2□	2.9mH	110μH	1.2A	300Vac
PLY17BN3721R0A2□	3.7mH	140μH	1.0A	300Vac
PLY17BN5620R8A2□	5.6mH	210μH	0.8A	300Vac

Operating Temperature Range (Ambient Temperature Range + Winding Temperature Rise): -25°C to 120°C
 Winding Temperature Rise (at Rated Current) (max.): 60K

Continued on the following page.

● This data sheet is applied for AC Line Filters Hybrid Choke Coils used for General Electronics equipment for your design.

Note:

1. This datasheet is downloaded from the website of Murata Manufacturing co., Ltd. Therefore, it's specifications are subject to change or our products in it may be discontinued without advance notice. Please check with our sales representatives or product engineers before ordering.
2. This datasheet has only typical specifications because there is no space for detailed specifications. Therefore, please approve our product specifications or transact the approval sheet for product specifications before ordering.

Continued from the preceding page.

Part Number	Common Mode Inductance (min.)	Normal Mode Inductance (min.)	Rated Current	Rated Voltage
PLY17BN7820R7A2□	7.8mH	290μH	0.7A	300Vac
PLY17BN9320R6A2□	9.3mH	350μH	0.6A	300Vac

Operating Temperature Range (Ambient Temperature Range + Winding Temperature Rise): -25°C to 120°C
 Winding Temperature Rise (at Rated Current) (max.): 60K

PLY17 Series B Type

Dimension

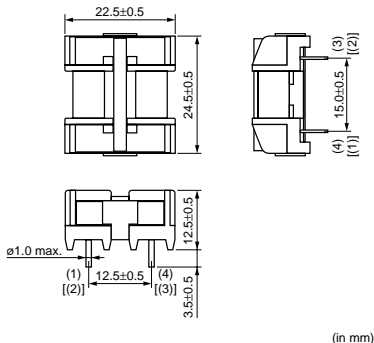

Common Mode Insertion Loss-Frequency Characteristics

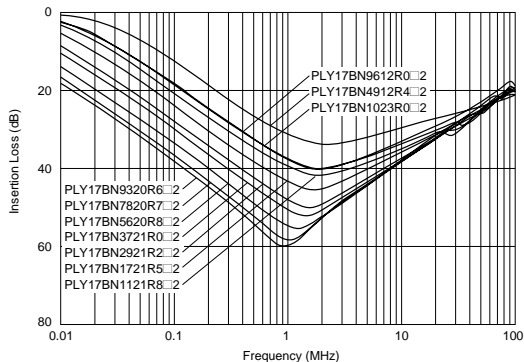

Differential Mode Insertion Loss-Frequency Characteristics

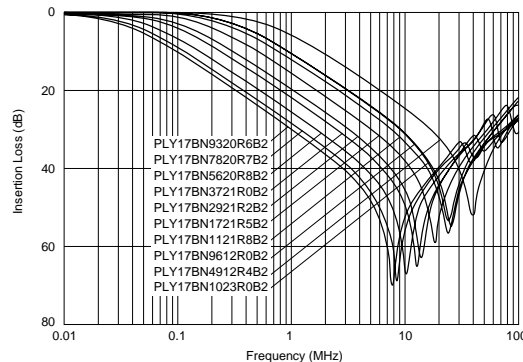

Rated Value (□: packaging code)

Part Number	Common Mode Inductance (min.)	Normal Mode Inductance (min.)	Rated Current	Rated Voltage
PLY17BN4912R4B2□	0.49mH	24μH	2.4A	300Vac
PLY17BN9612R0B2□	0.96mH	47μH	2.0A	300Vac
PLY17BN1023R0B2□	1.0mH	47μH	3.0A	300Vac
PLY17BN1121R8B2□	1.1mH	58μH	1.8A	300Vac
PLY17BN1721R5B2□	1.7mH	88μH	1.5A	300Vac

Operating Temperature Range (Ambient Temperature Range + Winding Temperature Rise): -25°C to 120°C
 Winding Temperature Rise (at Rated Current) (max.): 60K

Continued on the following page. ↗

● This data sheet is applied for AC Line Filters Hybrid Choke Coils used for General Electronics equipment for your design.

Note:

1. This datasheet is downloaded from the website of Murata Manufacturing co., Ltd. Therefore, it's specifications are subject to change or our products in it may be discontinued without advance notice. Please check with our sales representatives or product engineers before ordering.
2. This datasheet has only typical specifications because there is no space for detailed specifications. Therefore, please approve our product specifications or transact the approval sheet for product specifications before ordering.

 Continued from the preceding page.

Part Number	Common Mode Inductance (min.)	Normal Mode Inductance (min.)	Rated Current	Rated Voltage
PLY17BN2921R2B2□	2.9mH	140μH	1.2A	300Vac
PLY17BN3721R0B2□	3.7mH	180μH	1.0A	300Vac
PLY17BN5620R8B2□	5.6mH	280μH	0.8A	300Vac
PLY17BN7820R7B2□	7.8mH	390μH	0.7A	300Vac
PLY17BN9320R6B2□	9.3mH	460μH	0.6A	300Vac

Operating Temperature Range (Ambient Temperature Range + Winding Temperature Rise): -25°C to 120°C

Winding Temperature Rise (at Rated Current) (max.): 60K

■ Equivalent Circuit

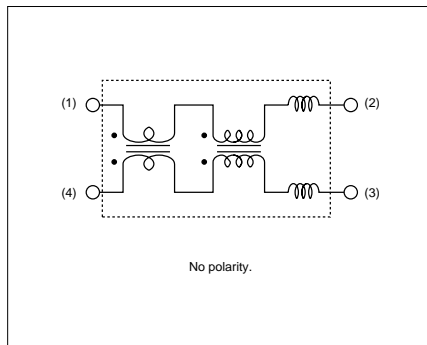

■ Packaging

Code	Packaging	Minimum Quantity
M	Magazine	1920
B	Box	1080

■ ⚠ Caution (Rating)

1. Rated Current

Operating current should not exceed the rated value. Even if operating current is under the rated value, adequate ventilation is required to avoid excessive heat generated within the product (choke coil) and from surrounding heat sources.

If exceeding these conditions, excessive heat may cause fumes or permanent damage to the product. Please ensure that product (choke coil) is evaluated and confirmed against the specification when it is mounted in your final assembled product.

-> Winding temperature should be less than 120 degree C.

*As for FKOB series winding temperature should be less than 95 degree C.

Maximum allowable temperature at the surface of coil (ambient temperature + winding temperature rise) is in accordance with each safety standard applicable to final assembled product.

When the temperature at winding exceeds maximum allowable temperature of safety standard, the rated current should be derated.

2. Inrush Current

Inrush current should not exceed 10 times rated current within 1/4 cycle of 50/60Hz commercial power line. Inrush current should be limited to a minimum of 10 seconds after last inrush.

If these conditions are exceeded, excessive heat may cause fumes or permanent damage to the component, or at worst cause ignition.

● This data sheet is applied for AC Line Filters Hybrid Choke Coils used for General Electronics equipment for your design.

⚠ Note:

- This datasheet is downloaded from the website of Murata Manufacturing co., Ltd. Therefore, it's specifications are subject to change or our products in it may be discontinued without advance notice. Please check with our sales representatives or product engineers before ordering.
- This datasheet has only typical specifications because there is no space for detailed specifications. Therefore, please approve our product specifications or transact the approval sheet for product specifications before ordering.

■ Notice (Soldering and Mounting)

Magnetic Flux Leakage

Choke coils generate small amounts of magnetic flux leakage that may adversely affect equipment operation according to component arrangement.

Testing should be completed on final assembly to ensure equipment performance is not affected.

■ Notice (Other)

Coil Humming Noise

Magnetic flux generated between coil and core or between the choke coil windings creates repulsive power between the coil windings. This repulsive power causes the coil winding to vibrate and create a humming noise. The amount of hum produced by the coil is proportionate to the amount of harmonic distortion generated by the operating current. This does not influence the electrical performance of the coils, but it should be considered and tested in actual circuit application.