

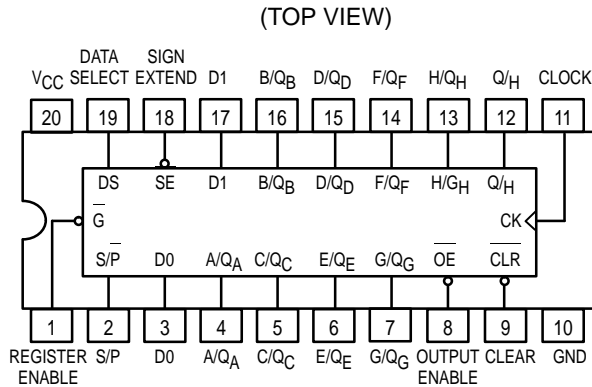

8-BIT SHIFT REGISTERS WITH SIGN EXTEND

These 8-bit shift registers have multiplexed input/output data ports to accomplish full 8-bit data handling in a single 20-pin package. Serial data may enter the shift-right register through either D0 or D1 inputs as selected by the data select pin. A serial output is also provided. Synchronous parallel loading is achieved by taking the register enable and the S/P inputs low. This places the three-state input/output ports in the data input mode. Data is entered on the low-to-high clock transition. The data extend function repeats the sign in the Q_A flip-flop during shifting. An overriding clear input clears the internal registers when taken low whether the outputs are enabled or off. The output enable does not affect synchronous operation of the register.

- Multiplexed Inputs/Outputs Provide Improved Bit Density
- Sign Extend Function
- Direct Overriding Clear
- 3-State Outputs Drive Bus Lines Directly



SN54/74LS322A

8-BIT SHIFT REGISTERS WITH SIGN EXTEND
LOW POWER SCHOTTKY

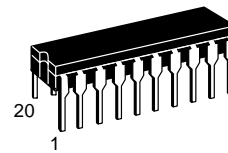

J SUFFIX
CERAMIC
CASE 732-03

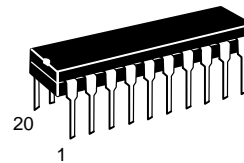

N SUFFIX
PLASTIC
CASE 738-03

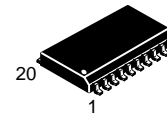

DW SUFFIX
SOIC
CASE 751D-03

ORDERING INFORMATION

SN54LSXXXJ Ceramic
SN74LSXXXN Plastic
SN74LSXXXDW SOIC

GUARANTEED OPERATING RANGES

Symbol	Parameter		Min	Typ	Max	Unit
V _{CC}	Supply Voltage	54 74	4.5 4.75	5.0 5.0	5.5 5.25	V
T _A	Operating Ambient Temperature Range	54 74	-55 0	25 25	125 70	°C
I _{OH}	Output Current — High Q _H '	54, 74			-0.4	mA
I _{OL}	Output Current — Low Q _H '	54 74			4.0 8.0	mA
I _{OH}	Output Current — High Q _A -Q _H	54 74			-1.0 -2.6	mA
I _{OL}	Output Current — Low Q _A -Q _H	54 74			12 24	mA

SN54/74LS322A

BLOCK DIAGRAM

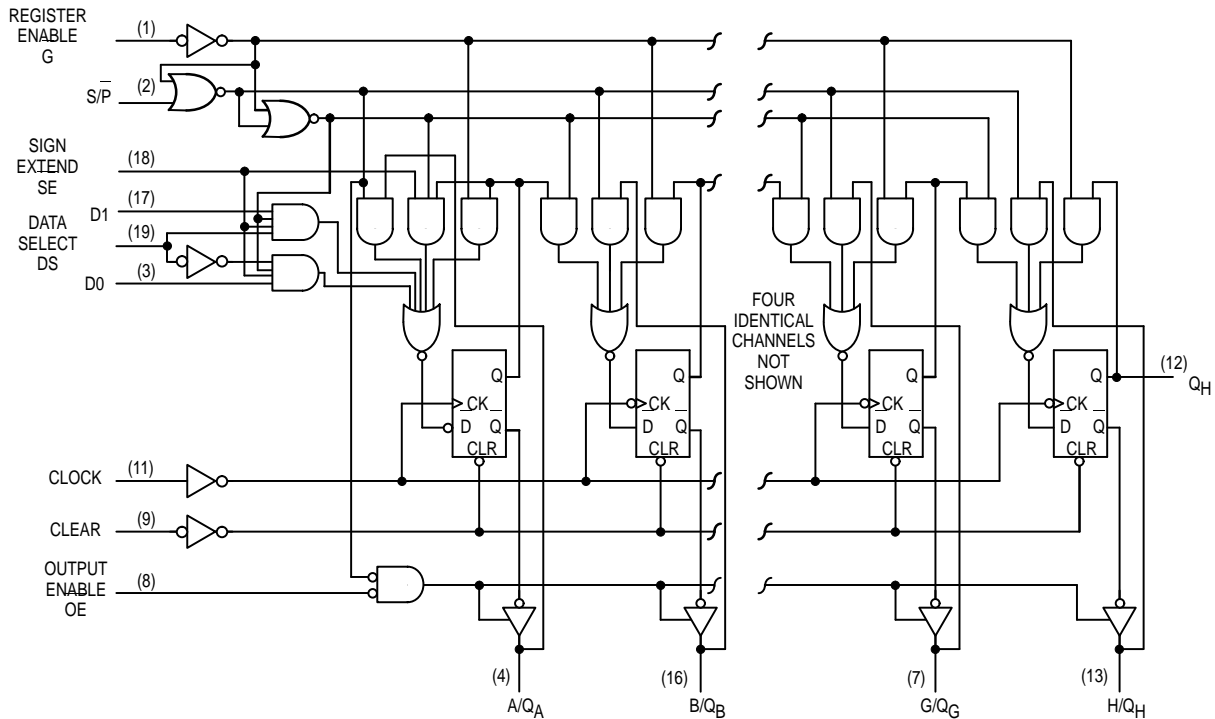

FUNCTION TABLE

OPERATION	INPUTS							INPUTS/OUTPUTS				OUTPUT QH'
	CLEAR	REGISTER ENABLE	S/P	SIGN EXTEND	DATA SELECT	OUTPUT ENABLE	CLOCK	A/QA	B/QB	C/QC ...	H/QH	
Clear	L	H	X	X	X	L	X	L	L	L	L	L
	L	X	H	X	X	L	X	L	L	L	L	L
Hold	H	H	X	X	X	L	X	QA0	QB0	QC0	QH0	QH0
Shift Right	H	L	H	H	L	L	↑	D0	QAn	QBn	QGn	QGn
	H	L	H	H	H	L	↑	D1	QAn	QBn	QGn	QGn
Sign Extend	H	L	H	L	X	L	↑	QAn	QAn	QBn	QGn	QGn
Load	H	L	L	X	X	X	↑	a	b	c	h	h

When the output enable is high, the eight input/output terminals are disabled to the high-impedance state; however, sequential operation or clearing of the register is not affected. If both the register enable input and the S/P input are low while the clear input is low, the register is cleared while the eight input/output terminals are disabled to the high-impedance state.

H = HIGH Level (steady state)

L = LOW Level (steady state)

X = Irrelevant (any input, including transitions)

↑ = Transition from LOW to HIGH level

QA0...QH0 = the level of QA through QH, respectively, before the indicated steady-state conditions were established

QAn...QHn = the level of QA through QH, respectively, before the most recent ↑ transition of the clock

D0, D1 = the level of steady-state inputs at inputs D0 and D1 respectively

a...h = the level of steady-state inputs at inputs A through H respectively

SN54/74LS32A

DC CHARACTERISTICS OVER OPERATING TEMPERATURE RANGE (unless otherwise specified)

Symbol	Parameter		Limits			Unit	Test Conditions	
			Min	Typ	Max			
V _{IH}	Input HIGH Voltage		2.0			V	Guaranteed Input HIGH Voltage for All Inputs	
V _{IL}	Input LOW Voltage	54			0.7	V	Guaranteed Input LOW Voltage for All Inputs	
		74			0.8			
V _{IK}	Input Clamp Diode Voltage			-0.65	-1.5	V	V _{CC} = MIN, I _{IN} = -18 mA	
V _{OH}	Output HIGH Voltage Q _A -Q _H	54	2.4	3.2		V	V _{CC} = MIN, I _{OH} = MAX	
		74	2.4	3.2		V		
V _{OH}	Output HIGH Voltage Q _H '	54	2.5	3.4		V	V _{CC} = MIN, I _{OH} = MAX	
		74	2.7	3.4		V		
V _{OL}	Output LOW Voltage Q _A -Q _H	54, 74		0.25	0.4	V	I _{OL} = 12 mA	V _{CC} = V _{CC} MIN, V _{IN} = V _{IL} or V _{IH} per Truth Table
		74		0.35	0.5	V	I _{OL} = 24 mA	
V _{OL}	Output LOW Voltage Q _H '	54, 74			0.4	V	I _{OL} = 4.0 mA	V _{CC} = V _{CC} MIN, V _{IN} = V _{IL} or V _{IH} per Truth Table
		74			0.5	V	I _{OL} = 8.0 mA	
I _{OZH}	Output Off Current HIGH Q _A -Q _H				40	μA	V _{CC} = MAX, V _{OUT} = 2.7 V	
I _{OZL}	Output Off Current LOW Q _A -Q _H				-400	μA	V _{CC} = MAX, V _{OUT} = 0.4 V	
I _{IH}	Input HIGH Current	Other			20	μA	V _{CC} = MAX, V _{IN} = 2.7 V	
		A-H, Data Select			40	μA		
		Sign Extend			60	μA		
		Other			0.1	mA	V _{CC} = MAX, V _{IN} = 7.0 V	
		Data Select			0.2	mA		
		Sign Extend			0.3	mA		
A-H			0.1	mA	V _{CC} = MAX, V _{IN} = 5.5 V			
I _{IL}	Input LOW Current	Other			-0.4	mA	V _{CC} = MAX, V _{IN} = 0.4 V	
		Data Select			-0.8	mA		
		Sign Extend			-1.2	mA		
I _{OS}	Short Circuit Current (Note 1)	Q _H '	-20		-100	mA	V _{CC} = MAX	
		Q _A -Q _H	-30		-130	mA	V _{CC} = MAX	
I _{CC}	Power Supply Current				60	mA	V _{CC} = MAX	

Note 1: Not more than one output should be shorted at a time, nor for more than 1 second.

SN54/74LS322A

AC CHARACTERISTICS ($T_A = 25^\circ\text{C}$, $V_{CC} = 5.0\text{ V}$)

Symbol	Parameter	Limits			Unit	Test Conditions
		Min	Typ	Max		
f_{MAX}	Maximum Clock Frequency	25	35		MHz	$C_L = 15\text{ pF}$
t_{PHL} t_{PLH}	Propagation Delay, Clock to Q_H'		26 22	35 33	ns	
t_{PHL}	Propagation Delay, Clear to Q_H'		27	35	ns	
t_{PHL} t_{PLH}	Propagation Delay, Clock to Q_A-Q_H		22 16	33 25	ns	$C_L = 45\text{ pF}$, $R_L = 667\ \Omega$
t_{PHL}	Propagation Delay, Clear to Q_A-Q_H		22	35	ns	
t_{PZH} t_{PZL}	Output Enable Time		15 15	35 35	ns	
t_{PHZ} t_{PLZ}	Output Disable Time		15 15	25 25	ns	$C_L = 5.0\text{ pF}$

AC SETUP REQUIREMENTS ($T_A = 25^\circ\text{C}$, $V_{CC} = 5.0\text{ V}$)

Symbol	Parameter	Limits			Unit	Test Conditions
		Min	Typ	Max		
t_W	Clock Pulse Width HIGH	25			ns	$V_{CC} = 5.0\text{ V}$
t_W	Clock Pulse Width LOW	15			ns	
t_W	Clear Pulse Width LOW	20			ns	
t_S	Data Setup Time	20			ns	
t_S	Select Setup Time	15			ns	
t_H	Data Hold Time	0			ns	
t_H	Select Hold Time	10			ns	
t_{rec}	Recovery Time	20			ns	

DEFINITIONS OF TERMS

SETUP TIME (t_S) — is defined as the minimum time required for the correct logic level to be present at the logic input prior to the clock transition from LOW-to-HIGH in order to be recognized and transferred to the outputs.

HOLD TIME (t_H) — is defined as the minimum time following the clock transition from LOW-to-HIGH that the logic level must be maintained at the input in order to ensure continued

recognition. A negative HOLD TIME indicates that the correct logic level may be released prior to the clock transition from LOW-to-HIGH and still be recognized.

RECOVERY TIME (t_{rec}) — is defined as the minimum time required between the end of the reset pulse and the clock transition from LOW-to-HIGH in order to recognize and transfer HIGH Data to the Q outputs.