

**High Dynamic Range Low Noise Amplifier
400 - 500 MHz**

MAAL-008624
V1

Features

- Low Noise Figure: 0.9 dB
- High OIP3: +28 dBm at 5 V, 60 mA bias
- High Gain: 21 dB
- Single Supply: +3 to +8 VDC
- Lead-Free SOIC-8 Package
- 100% Matte Tin Plating over Copper
- Halogen-Free "Green" Mold Compound
- 260° C Reflow Compatible
- RoHS* Compliant Version of MAALSS0025
- Adjustable current: 20 to 80 mA with external resistor

Description

M/A-COM's MAAL-008624 is a high dynamic range, low noise GaAs MMIC amplifier in a low cost, surface mount package. It employs external input matching to obtain optimum noise figure performance and operating frequency flexibility.

The MAAL-008624 also features flexible biasing to control the current consumption vs. dynamic range trade-off. The MAAL-008624 can operate from any supply voltage in the 3 V to 8 V range. Its current can be controlled over a range of 20 mA to 80 mA with an external resistor.

The MAAL-008624 is ideally suited for use where low noise figure, high gain, high dynamic range, and low power consumption are required. Typical applications include receiver front ends in CDMA450 base stations. It is also useful as a gain block, buffer, driver, and IF amplifier in both fixed and portable cellular and 450 MHz ISM systems.

The MAAL-008624 is fabricated using a low-cost 0.5-micron gate length GaAs process. The process features full passivation for increased performance reliability.

Ordering Information¹

| Part Number | Package |
|--------------------|-----------------|
| MAAL-008624-000000 | Bulk Packaging |
| MAAL-008624-TR3000 | 3000 piece reel |

1. Reference Application Note M513 for reel size information.

* Restrictions on Hazardous Substances, European Union Directive 2002/95/EC.

Functional Block Diagram

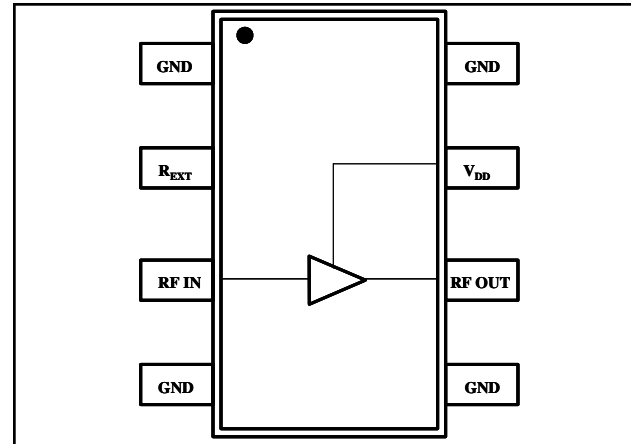

Pin Configuration

| Pin No. | Pin Name | Description |
|---------|------------------|-------------------------------------|
| 1 | GND | RF and DC Ground |
| 2 | R _{EXT} | External Current Control (optional) |
| 3 | RF IN | RF Input |
| 4 | GND | RF and DC Ground |
| 5 | GND | RF and DC Ground |
| 6 | RF OUT | RF Output |
| 7 | V _{DD} | Positive supply voltage |
| 8 | GND | RF and DC Ground |

Absolute Maximum Ratings²

| Parameter | Absolute Maximum |
|----------------------------------|------------------|
| V _{DD} | +10 VDC |
| Input Power | +10 dBm |
| Current ³ | 120 mA |
| Channel Temperature ⁴ | +150°C |
| Operating Temperature | -40°C to +85°C |
| Storage Temperature | -65°C to +150°C |

2. Exceeding any one or combination of these limits may cause permanent damage to this device.
3. When pin #2 is used to increase current (see note 5).
4. Thermal resistance (θ_{jc}) = +88°C/W.

High Dynamic Range Low Noise Amplifier
400 - 500 MHz

MAAL-008624
V1

Electrical Specifications: $T_A = +25^\circ\text{C}$, $Z_0 = 50\ \Omega$, $F = 450\ \text{MHz}$, $P_{in} = -30\ \text{dBm}$

| Parameter | Test Conditions | Units | Min | Typ | Max |
|----------------------------|-------------------------|-------|-----|------|-----|
| Gain | 5 V, 60 mA ⁵ | dB | 19 | 21 | 24 |
| Noise Figure | 5 V, 60 mA ⁵ | dB | — | 0.9 | 1.4 |
| Input Return Loss | — | dB | — | 9 | — |
| Output Return Loss | — | dB | — | 11 | — |
| Output 1 dB Compression | 5 V, 60 mA ⁵ | dBm | — | 16.5 | — |
| Output IP3 | 5 V, 60 mA ⁵ | dBm | — | 28 | — |
| Input IP3 | 5 V, 60 mA ⁵ | dBm | 3 | 7 | — |
| Reverse Isolation | — | dB | — | 34 | — |

5. Using external 15-ohm resistor. See functional schematic.

Functional Schematic

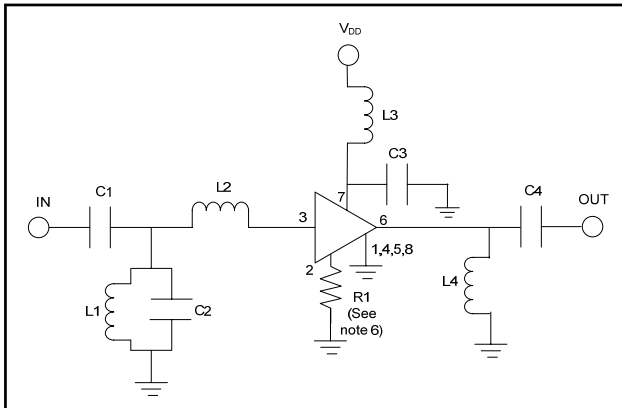

External Circuitry Parts List

| Part | Value | Purpose |
|------|---------|---------------------------------------|
| C1 | 100 pF | DC Block |
| C2 | 8 pF | Input Matching |
| C3 | 470 pF | Bypass |
| C4 | 4 pF | Output Matching |
| L1 | 22 nH | Input Matching |
| L2 | 43 nH | Input Matching |
| L3 | 12 nH | RF Choke |
| L4 | 11 nH | Output Matching |
| R1 | 15 Ohms | Optional current control ⁶ |

Handling Procedures

The following precautions should be observed to avoid damage:

Static Sensitivity

Gallium Arsenide Integrated Circuits are sensitive to electrostatic discharge (ESD) and can be damaged by static electricity. Proper ESD control techniques should be used when handling these devices.

6. Pin 2 allows use of an external resistor to ground for optional, higher current. For 20 mA operation, no resistor is used.

For $I_{DD} \sim 40\ \text{mA}$, $R_2 = 43\ \text{ohms}$;
 $I_{DD} \sim 60\ \text{mA}$, $R_2 = 15\ \text{ohms}$;
 $I_{DD} \sim 80\ \text{mA}$, $R_2 = 10\ \text{ohms}$.

High Dynamic Range Low Noise Amplifier
400 - 500 MHz

MAAL-008624
V1

Typical Performance Curves over Temperature

Gain

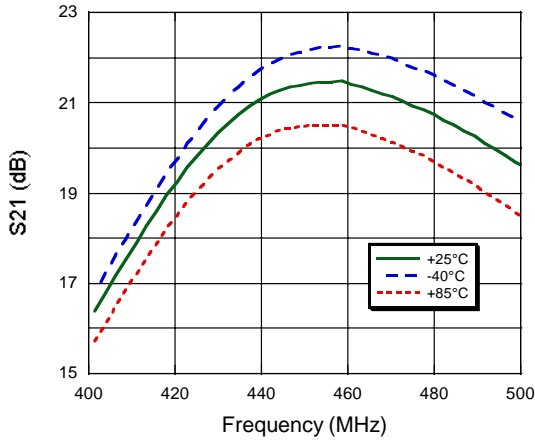

Reverse Isolation

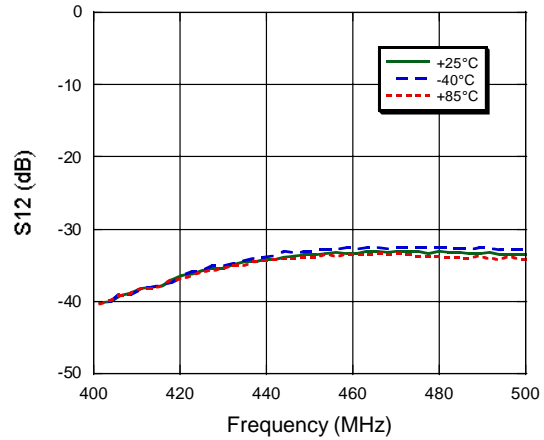

Input Return Loss

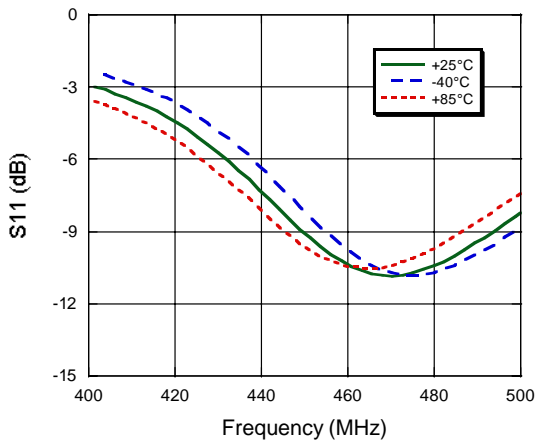

Output Return Loss

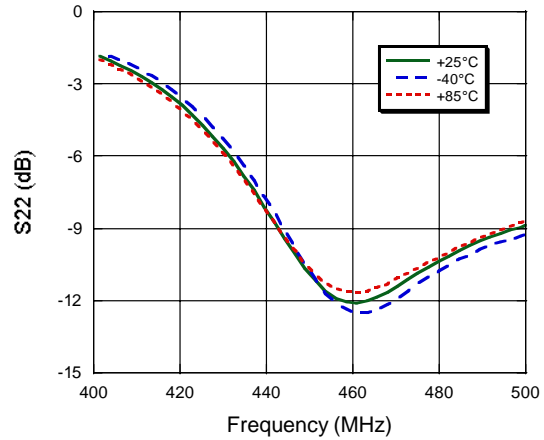

Noise Figure

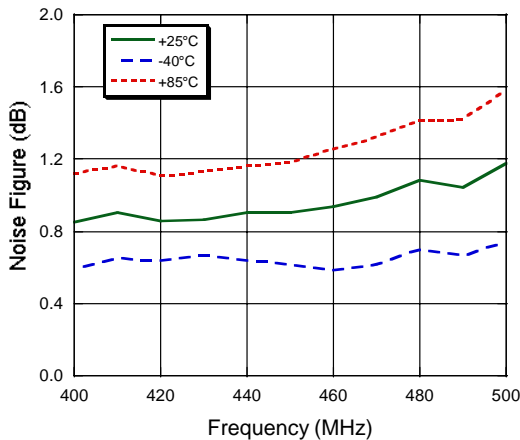

Output IP3

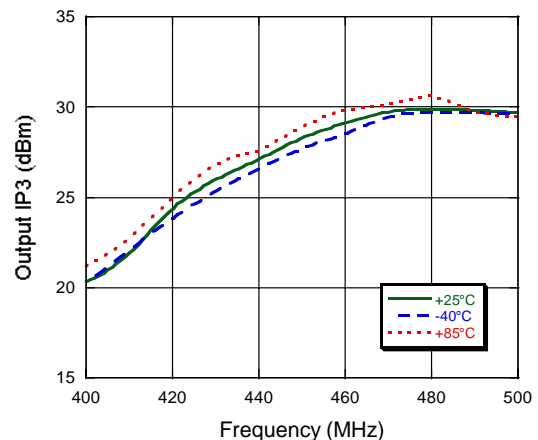

**High Dynamic Range Low Noise Amplifier
400 - 500 MHz**

MAAL-008624
V1

Lead-Free SOIC-8[†]

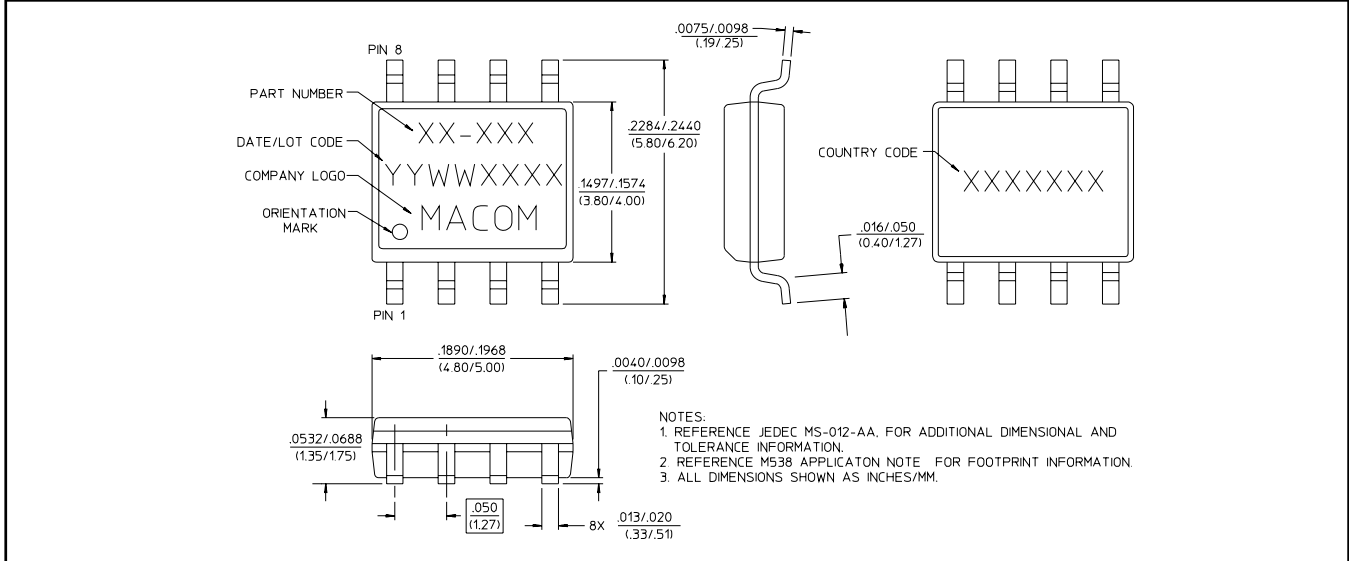

[†] Reference Application Note M538 for lead-free solder reflow recommendations.
Meets JEDEC moisture sensitivity level 1 requirements.

Recommended PCB Configuration

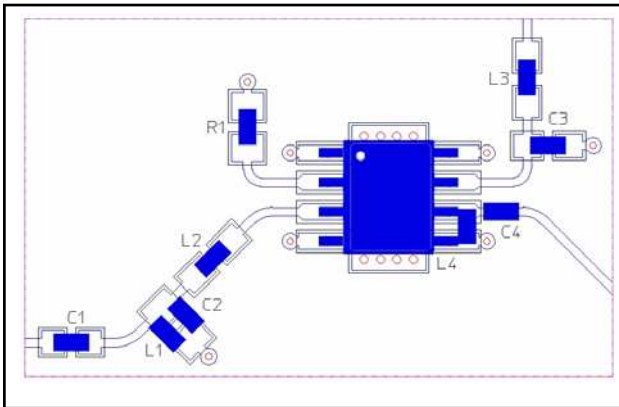

Cross Section View

