

**High Dynamic Range Low Noise Amplifier
800 - 1000 MHz**

**MAAL-008091
V1**

Features

- Low Noise Figure: 1.2 dB
- High Input IP3: +18 dBm at 8 V, 60 mA bias
+6.5 dBm at 3 V, 20 mA bias
- High Gain: 15 dB
- Single Supply: +3 to +8 VDC
- Adjustable current: 20 to 80 mA with external resistor
- Lead-Free SOIC-8 Package
- 100% Matte Tin Plating over Copper
- Halogen-Free "Green" Mold Compound
- 260°C Reflow Compatible
- RoHS* Compliant Version of AM50-0003

Description

M/A-COM's MAAL-008091 is a high dynamic range, GaAs MMIC, low noise amplifier in a lead-free SOIC-8, surface mount plastic package. It employs external input matching to obtain optimum noise figure performance and operating frequency flexibility.

The MAAL-008091 also features flexible biasing to control the current consumption vs. dynamic range trade-off. The MAAL-008091 can operate from any supply voltage in the 3 V to 8 V range. Its current can be controlled over a range of 20 mA to 80 mA with an external resistor.

The MAAL-008091 is ideally suited for use where low noise figure, high gain, high dynamic range, and low power consumption are required. Typical applications include receiver front ends in AMPS, GSM, and ETACS base stations. It is also useful as a gain block, buffer, driver, and IF amplifier in both fixed and portable cellular and 900 MHz ISM systems.

The MAAL-008091 is fabricated using a low-cost 0.5-micron gate length GaAs process. The process features full passivation for increased performance reliability.

Functional Block Diagram

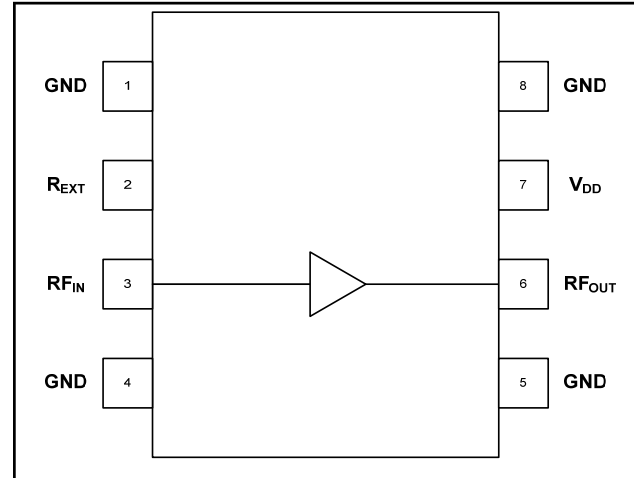

Pin Configuration

Pin No.	Pin Name	Description
1	GND	RF and DC Ground
2	R _{EXT}	External Current Control (optional)
3	R _{F IN}	RF Input of the amplifier
4	GND	RF and DC Ground
5	GND	RF and DC Ground
6	R _{F OUT}	RF Output of the amplifier
7	V _{DD}	Positive supply voltage
8	GND	RF and DC Ground

Ordering Information ¹

Part Number	Package
MAAL-008091-000000	Bulk Packaging
MAAL-008091-TR3000	3000 piece reel

1. Reference Application Note M513 for reel size information.

* Restrictions on Hazardous Substances, European Union Directive 2002/95/EC.

**High Dynamic Range Low Noise Amplifier
800 - 1000 MHz**

**MAAL-008091
V1**

Electrical Specifications: $T_A = +25^\circ\text{C}$, $F = 900\text{ MHz}$, $P_{IN} = -30\text{ dBm}$, $Z_0 = 50\ \Omega$

Parameter	Test Conditions	Units	Min.	Typ.	Max.
Gain	5 V, 60 mA ²	dB	13	15	—
	3 V, 20 mA	dB	12	13.5	—
Noise Figure	5 V, 60 mA ²	dB	—	1.20	1.50
	3 V, 20 mA	dB	—	1.25	1.50
Input VSWR	—	Ratio	—	2.0:1	—
Output VSWR	—	Ratio	—	1.5:1	—
Output 1 dB Compression	5 V, 60 mA ²	dBm	—	16.5	—
	3 V, 20 mA	dBm	—	8.5	—
Input IP3	5 V, 60 mA ²	dBm	12.5	15	—
	3 V, 20 mA	dBm	4.0	6.5	—
Reverse Isolation	—	dB	—	25	—

2. Using external 15 Ω resistor. See functional schematic.

Absolute Maximum Ratings^{3,4}

Parameter	Absolute Maximum
V_{DD}	+10 VDC
Input Power	+10 dBm
Current ⁵	120 mA
Channel Temperature ⁶	+150°C
Operating Temperature	-40°C to +85°C
Storage Temperature	-65°C to +150°C

3. Exceeding any one or combination of these limits may cause permanent damage to this device.
4. M/A-COM does not recommend sustained operation near these survivability limits.
5. When pin #2 is used to increase current (see note 8).
6. Thermal resistance (θ_{jc}) = +88°C/W.

Handling Procedures

Please observe the following precautions to avoid damage:

Static Sensitivity

Gallium Arsenide Integrated Circuits are sensitive to electrostatic discharge (ESD) and can be damaged by static electricity. Proper ESD control techniques should be used when handling these devices.

**High Dynamic Range Low Noise Amplifier
800 - 1000 MHz**

MAAL-008091
V1

Typical Performance Curves

Test Conditions: $T_A = +25^\circ\text{C}$, $Z_0 = 50 \Omega$, $V_{DD} = 5 \text{ V}$, $I_{DD} = 60 \text{ mA}$ unless otherwise specified.

Gain vs. Frequency

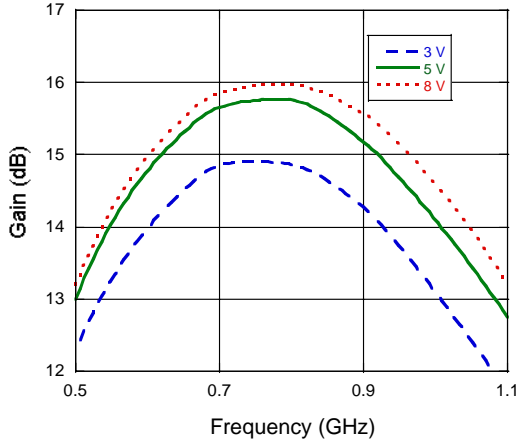

VSWR vs. Frequency

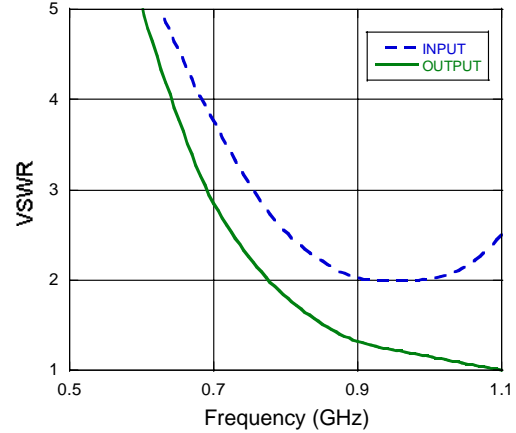

Noise Figure vs. Frequency

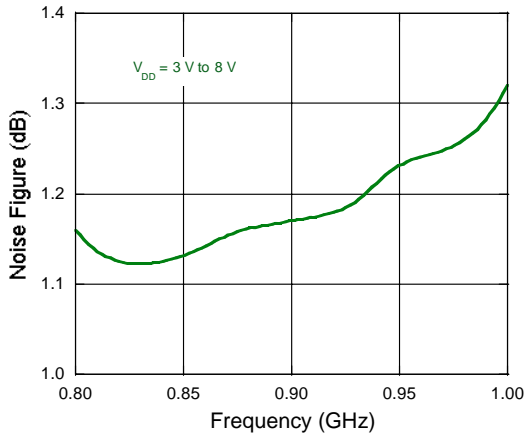

Noise Figure vs. Current, $F = 900 \text{ MHz}$

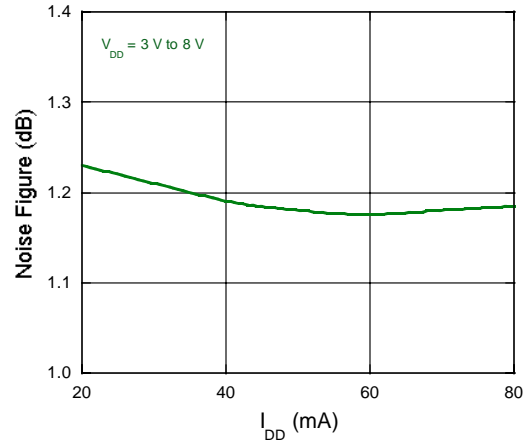

Output P1dB vs. Frequency

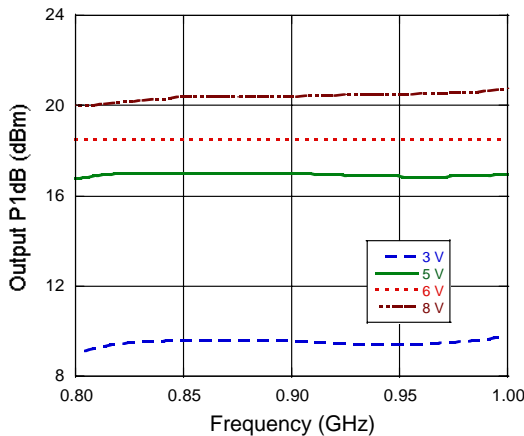

Output P1dB vs. Current, $F = 900 \text{ MHz}$

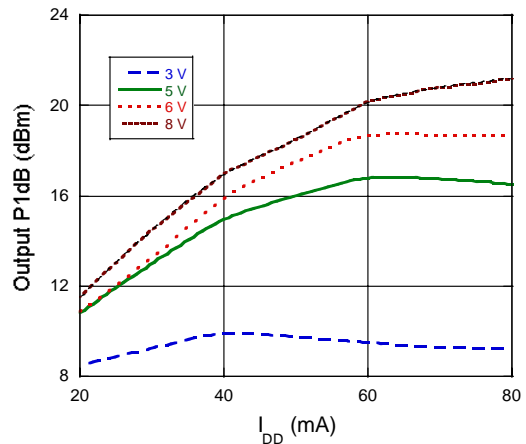

**High Dynamic Range Low Noise Amplifier
800 - 1000 MHz**

MAAL-008091
V1

Typical Performance Curves

Test Conditions: $T_A = +25^\circ\text{C}$, $Z_0 = 50 \Omega$, $V_{DD} = 5 \text{ V}$, $I_{DD} = 60 \text{ mA}$ unless otherwise specified.

Input IP3 vs. Frequency

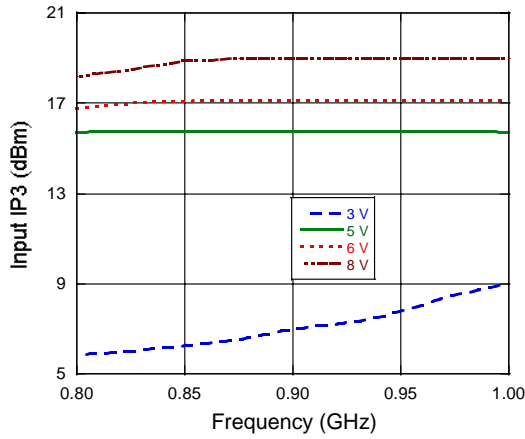

Input IP3 vs. Current, $F = 900 \text{ MHz}$

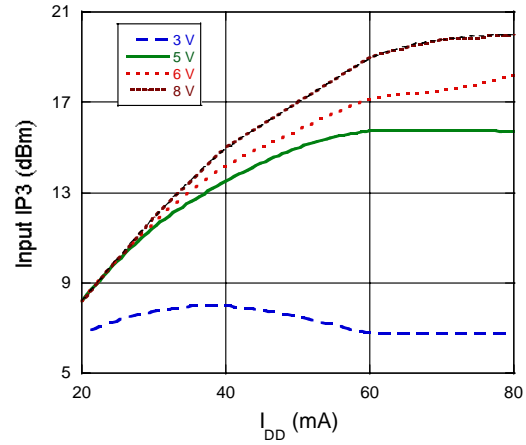

Lead-Free SOIC-8[†]

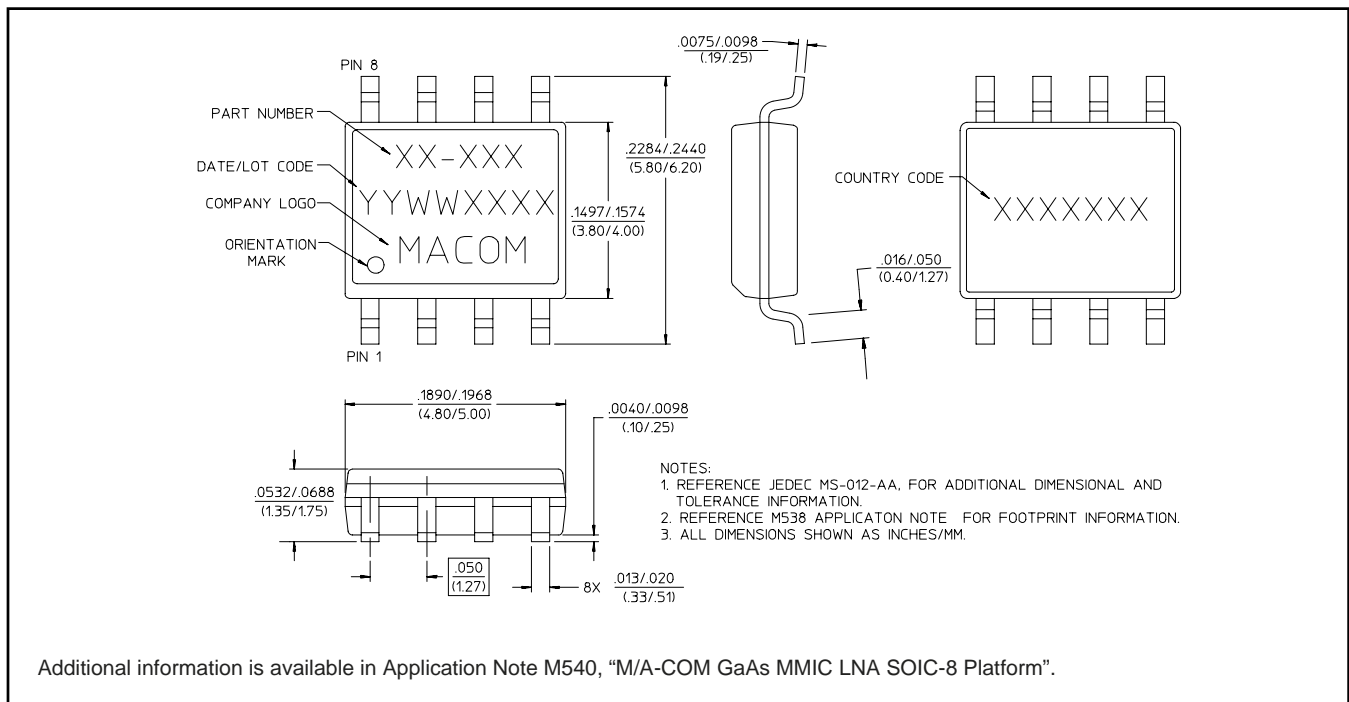

[†] Reference Application Note M538 for lead-free solder reflow recommendations.
Meets JEDEC moisture sensitivity level 1 requirements.

**High Dynamic Range Low Noise Amplifier
800 - 1000 MHz**

**MAAL-008091
V1**

Recommended PCB Configuration

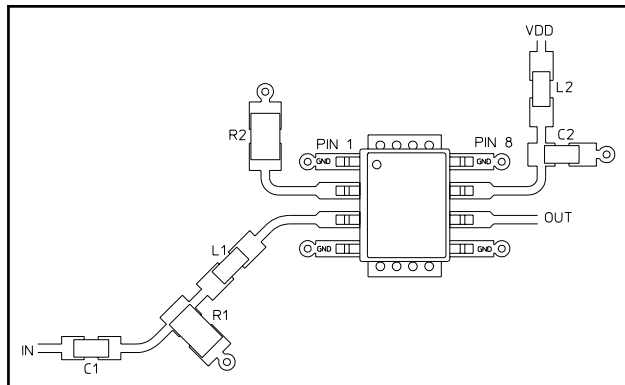

Cross Section View

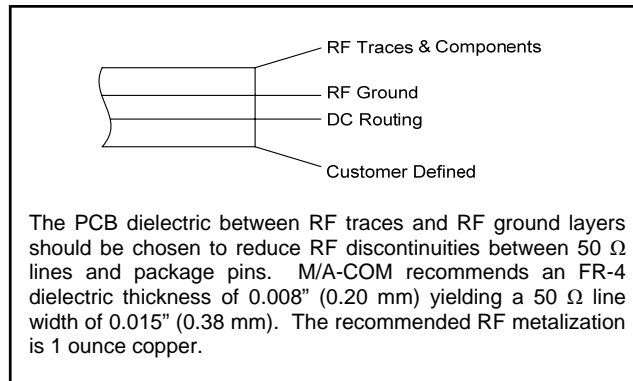

Functional Schematic

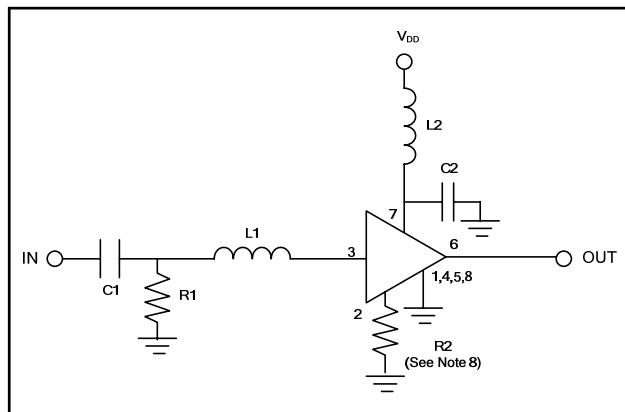

External Component List ⁷

Part	Value	Case Size	Manufacturer	Purpose
C1	47 pF	0603	Murata	DC Block
C2	470 pF	0603	Murata	By-Pass
L1	12 nH	0603	Coilcraft	Tuning
L2	12 nH	0603	Coilcraft	RF Choke
R1	5.1 K Ω	0603	Panasonic	DC Return
R2	See Note 8	0603	Panasonic	Optional current control

- All external components are readily available, low cost surface mount components.
- Pin 2 allows use of an external resistor to ground for optional, higher current. For 20 mA operation, no resistor is used.

For $I_{DD} \sim 40$ mA, $R2 = 43$ ohms;
 $I_{DD} \sim 60$ mA, $R2 = 15$ ohms;
 $I_{DD} \sim 80$ mA, $R2 = 10$ ohms.