



BTW67 and BTW69 Series

STANDARD

50A SCRs

MAIN FEATURES:

Symbol	Value	Unit
$I_{T(RMS)}$	50	A
V_{DRM}/V_{RRM}	600 to 1200	V
I_{GT}	80	mA

DESCRIPTION

Available in high power packages, the BTW67 / BTW69 Series is suitable in applications where power handling and power dissipation are critical, such as solid state relays, welding equipment, high power motor control.

Based on a clip assembly technology, they offer a superior performance in surge current handling capabilities.

Thanks to their internal ceramic pad, they provide high voltage insulation (2500V RMS), complying with UL standards (file ref: E81734).

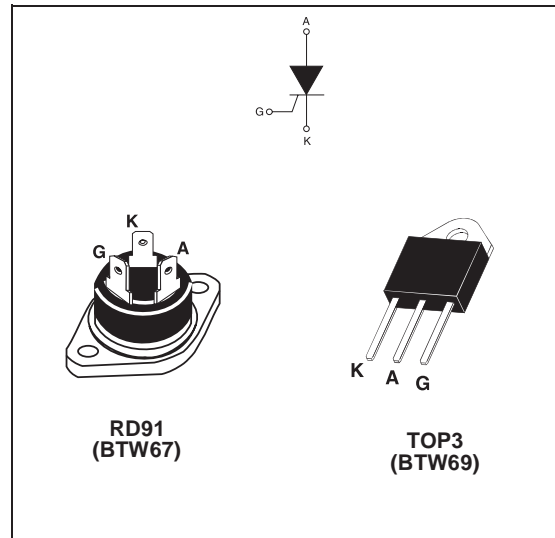

ABSOLUTE RATINGS (limiting values)

Symbol	Parameter	Value	Unit
$I_{T(RMS)}$	RMS on-state current (180° conduction angle)	RD91 T _c = 70°C	50 A
		TOP3 Ins. T _c = 75°C	
$I_{T(AV)}$	Average on-state current (180° conduction angle)	RD91 T _c = 70°C	32 A
		TOP3 Ins. T _c = 75°C	
I_{TSM}	Non repetitive surge peak on-state current	tp = 8.3 ms T _j = 25°C	610 A
		tp = 10 ms	
I^2t	I^2t Value for fusing	T _j = 25°C	1680 A ² s
di/dt	Critical rate of rise of on-state current I _G = 2 x I _{GT} , tr ≤ 100 ns	F = 60 Hz T _j = 125°C	50 A/μs
I _{GM}	Peak gate current	tp = 20 μs T _j = 125°C	8 A
P _{G(AV)}	Average gate power dissipation	T _j = 125°C	1 W
T _{stg} T _j	Storage junction temperature range Operating junction temperature range		- 40 to + 150 - 40 to + 125 °C
V _{RGM}	Maximum peak reverse gate voltage		5 V

BTW67 and BTW69 Series

ELECTRICAL CHARACTERISTICS (T_j = 25°C, unless otherwise specified)

Symbol	Test Conditions		Value	Unit	
I _{GT}	V _D = 12 V R _L = 33 Ω	MIN.	8	mA	
		MAX.	80		
V _{GT}		MAX.	1.3	V	
V _{GD}	V _D = V _{DRM} R _L = 3.3 kΩ	T _j = 125°C	MIN.	0.2	V
I _H	I _T = 500 mA Gate open		MAX.	150	mA
I _L	I _G = 1.2 I _{GT}		MAX.	200	mA
dV/dt	V _D = 67 % V _{DRM} Gate open	T _j = 125°C	MIN.	1000	V/μs
V _{TM}	I _{TM} = 100 A t _p = 380 μs	T _j = 25°C	MAX.	1.9	V
V _{t0}	Threshold voltage	T _j = 125°C	MAX.	1.0	V
R _d	Dynamic resistance	T _j = 125°C	MAX.	8.5	mΩ
I _{DRM} I _{RRM}	V _{DRM} = V _{RRM}	T _j = 25°C	MAX.	10	μA
		T _j = 125°C		5	mA

THERMAL RESISTANCES

Symbol	Parameter		Value	Unit
R _{th(j-c)}	Junction to case (DC)	RD91 (Insulated)	1.0	°C/W
		TOP3 Insulated	0.9	
R _{th(j-a)}	Junction to ambient	TOP3 Insulated	50	°C/W

PRODUCT SELECTOR

Part Number	Voltage (xxx)			Sensitivity	Package
	600 V	800 V	1200 V		
BTW67-xxx	X	X	X	80 mA	RD91
BTW69-xxx	X	X	X	80 mA	TOP3 Ins.

ORDERING INFORMATION

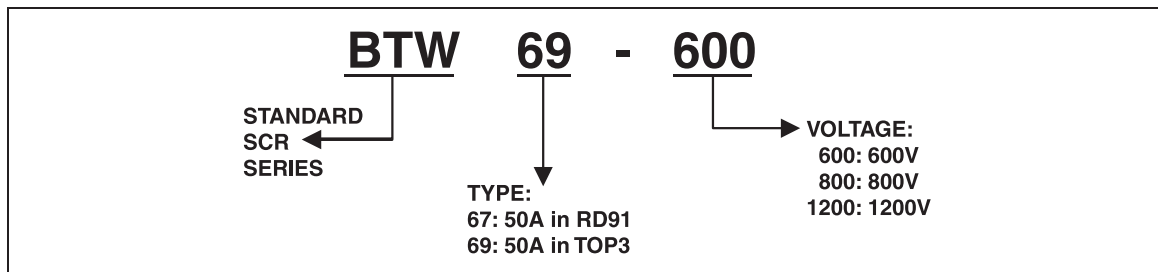

OTHER INFORMATION

Part Number	Marking	Weight	Base Quantity	Packing mode
BTW67-xxx	BTW67xxx	20.0 g	25	Bulk
BTW69-xxx	BTW69xxx	4.5 g	120	Bulk

Note: xxx = voltage

Fig. 1: Maximum average power dissipation versus average on-state current.

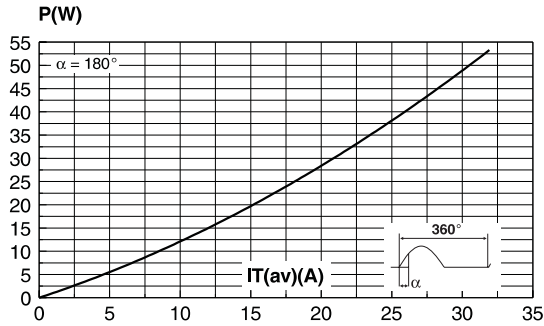

Fig. 2: Average and D.C. on-state current versus case temperature.

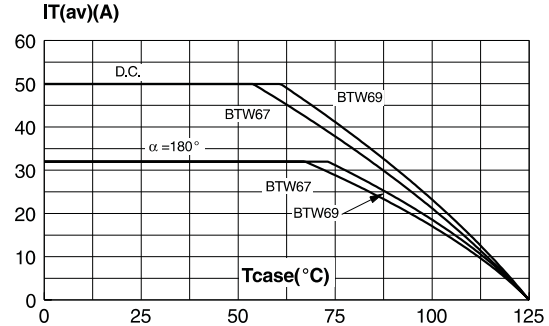

Fig. 3: Relative variation of thermal impedance versus pulse duration.

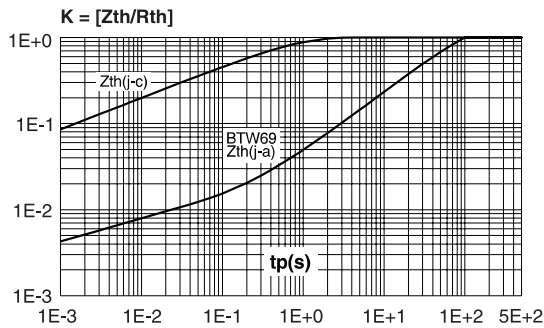

Fig. 4: Relative variation of gate trigger current, holding current and latching current versus junction temperature.

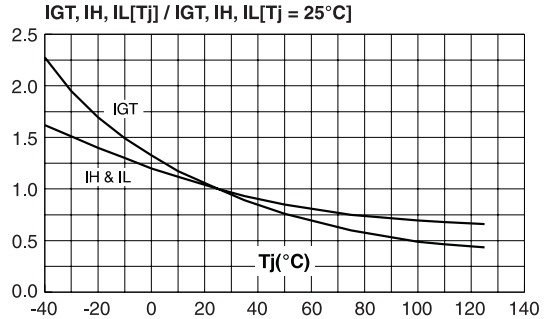

Fig. 5: Surge peak on-state current versus number of cycles.

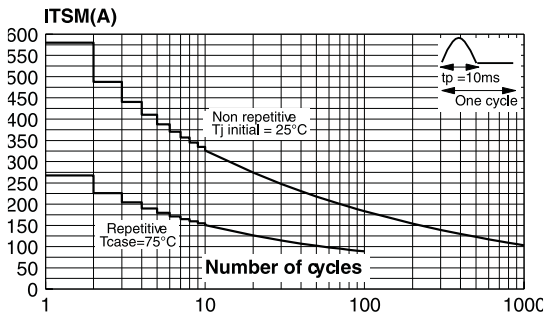
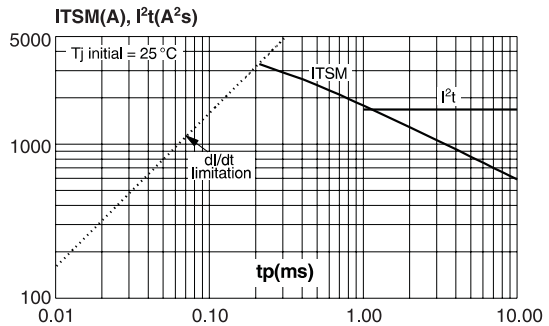
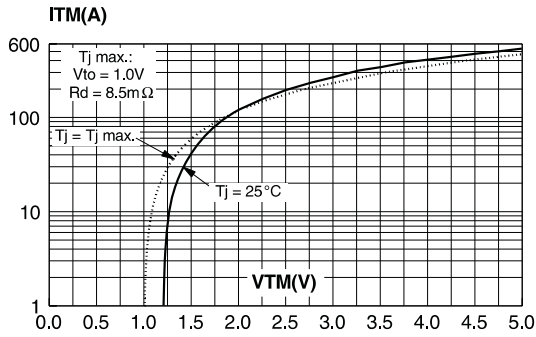

Fig. 6: Non-repetitive surge peak on-state current for a sinusoidal pulse with width $tp < 10ms$, and corresponding value of I^2t .



BTW67 and BTW69 Series

Fig. 7: On-state characteristics (maximum values).



PACKAGE MECHANICAL DATA

RD91 (Plastic)

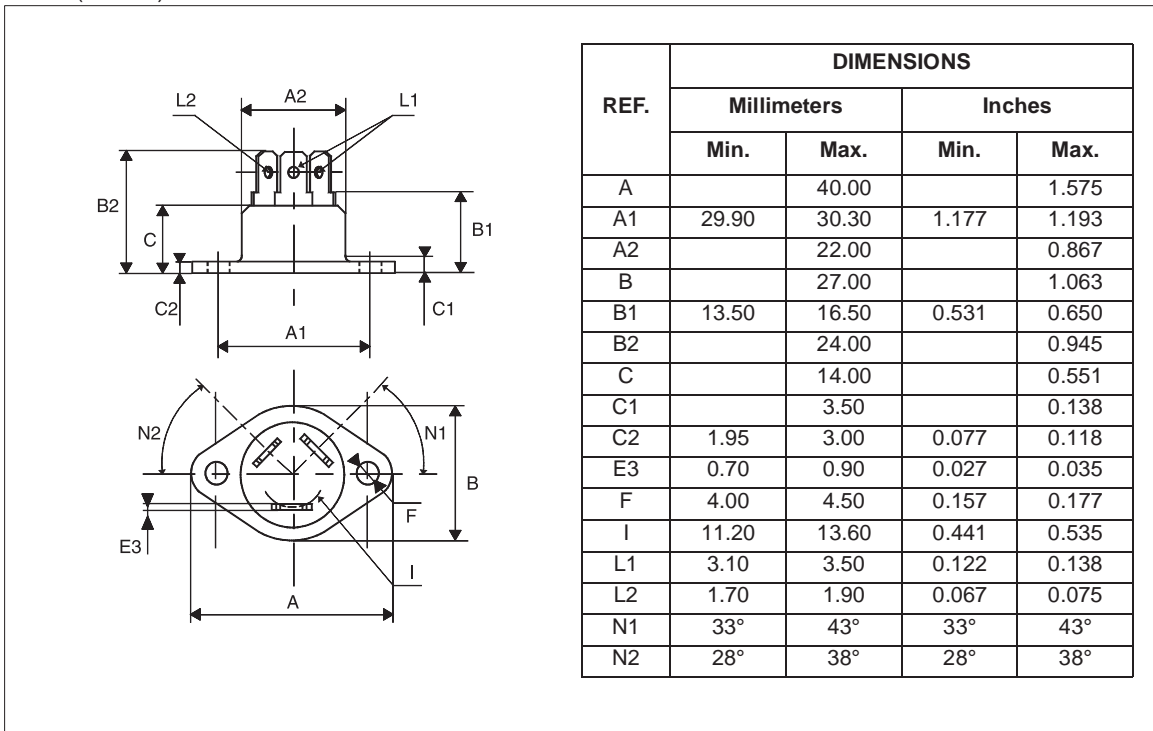

PACKAGE MECHANICAL DATA

TOP3 Ins.(Plastic)

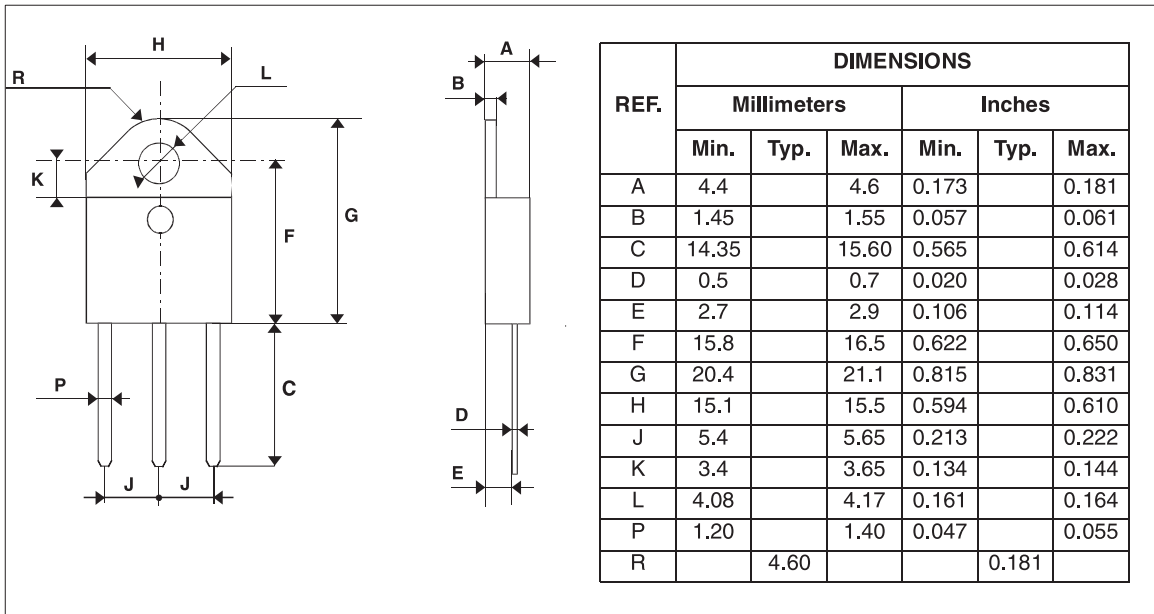

Information furnished is believed to be accurate and reliable. However, STMicroelectronics assumes no responsibility for the consequences of use of such information nor for any infringement of patents or other rights of third parties which may result from its use. No license is granted by implication or otherwise under any patent or patent rights of STMicroelectronics. Specifications mentioned in this publication are subject to change without notice. This publication supersedes and replaces all information previously supplied. STMicroelectronics products are not authorized for use as critical components in life support devices or systems without express written approval of STMicroelectronics.

© The ST logo is a registered trademark of STMicroelectronics

© 2001 STMicroelectronics - Printed in Italy - All rights reserved

STMicroelectronics GROUP OF COMPANIES

Australia - Brazil - China - Finland - France - Germany - Hong Kong - India - Italy - Japan - Malaysia-Malta - Morocco
Singapore - Spain - Sweden - Switzerland - United Kingdom - U.S.A.

<http://www.st.com>

