



MIC94310

200mA LDO with Ripple Blocker™ Technology



General Description

The MIC94310 Ripple Blocker™ is a monolithic integrated circuit that provides low-frequency ripple attenuation (switching noise rejection) to a regulated output voltage. This is important for applications where a DC/DC switching converter is required to lower or raise a battery voltage but where switching noise cannot be tolerated by sensitive downstream circuits such as in RF applications. The MIC94310 maintains high power supply ripple rejection (PSRR) with input voltages operating near the output voltage level to improve overall system efficiency. A low-voltage logic enable pin facilitates ON/OFF control at typical GPIO voltage levels.

The MIC94310 operates from an input voltage of 1.8V to 3.6V.

Packaged in a 0.88mm x 0.88mm 4-ball CSP or a 4-pin 1.2mm x 1.6mm Thin MLF®, the MIC94310 has a junction operating temperature range of -40°C to +125°C.

Data sheets and support documentation can be found on Micrel's web site at: www.micrel.com.

Features

- 1.8V to 3.6V input voltage range
- Active noise rejection over a wide frequency band
 - >50dB from 10Hz to 10MHz at 200mA load
- Rated to 200mA output current
- Fixed output voltages
- Current-limit and thermal-limit protected
- Ultra-small 0.88mm x 0.88mm 4-ball CSP
- 1.2mm x 1.6mm, 4-pin Thin MLF®
- Logic-controlled enable pin
- -40°C to +125°C junction temperature range

Applications

- Smart phones
- Tablet PC/notebooks and webcams
- Digital still and video cameras
- Global positioning systems
- Mobile computing
- Automotive and industrial applications

Typical Application

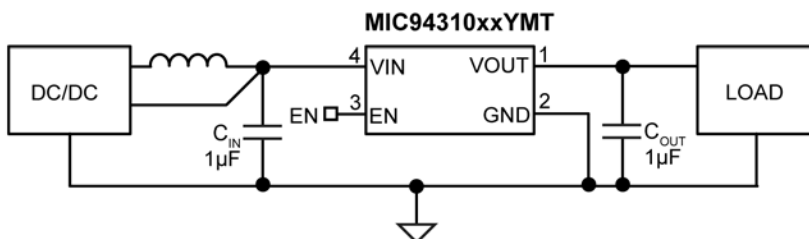

PSRR $C_{OUT} = 1\mu F$

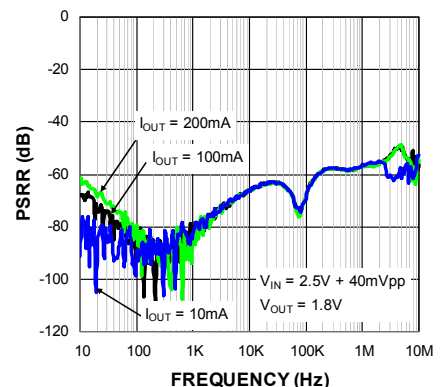

Ripple Blocker is a trademark of Micrel, Inc

MLF and MicroLeadFrame are registered trademarks of Amkor Technology, Inc.

Micrel Inc. • 2180 Fortune Drive • San Jose, CA 95131 • USA • tel +1 (408) 944-0800 • fax +1 (408) 474-1000 • <http://www.micrel.com>

Ordering Information

Part Number	Marking Code	Output Voltage	Package ^{2,3}	Lead Finish
MIC94310-4YCS	1Z	1.2V	0.88mm x 0.88mm CSP	Pb-Free
MIC94310-FYCS	2Z	1.5V	0.88mm x 0.88mm CSP	Pb-Free
MIC94310-GYCS ¹	Z9	1.8V	0.88mm x 0.88mm CSP	Pb-Free
MIC94310-DYCS ¹	Z8	1.85V	0.88mm x 0.88mm CSP	Pb-Free
MIC94310-JYCS ¹	Z7	2.5V	0.88mm x 0.88mm CSP	Pb-Free
MIC94310-MYCS ¹	Z6	2.8V	0.88mm x 0.88mm CSP	Pb-Free
MIC94310-NYCS ¹	Z5	2.85V	0.88mm x 0.88mm CSP	Pb-Free
MIC94310-PYCS	Z4	3.0V	0.88mm x 0.88mm CSP	Pb-Free
MIC94310-SYCS	Z3	3.3V	0.88mm x 0.88mm CSP	Pb-Free
MIC94310-4YMT	31T	1.2V	1.2mm x 1.6mm Thin MLF [®]	Pb-Free
MIC94310-FYMT	32T	1.5V	1.2mm x 1.6mm Thin MLF [®]	Pb-Free
MIC94310-GYMT	31G	1.8V	1.2mm x 1.6mm Thin MLF [®]	Pb-Free
MIC94310-DYMT ¹	31D	1.85V	1.2mm x 1.6mm Thin MLF [®]	Pb-Free
MIC94310-JYMT ¹	31J	2.5V	1.2mm x 1.6mm Thin MLF [®]	Pb-Free
MIC94310-MYMT ¹	31M	2.8V	1.2mm x 1.6mm Thin MLF [®]	Pb-Free
MIC94310-NYMT ¹	31N	2.85V	1.2mm x 1.6mm Thin MLF [®]	Pb-Free
MIC94310-PYMT	31P	3.0V	1.2mm x 1.6mm Thin MLF [®]	Pb-Free
MIC94310-SYMT	31S	3.3V	1.2mm x 1.6mm Thin MLF [®]	Pb-Free

Notes:

1. Contact Micrel Marketing for availability.
2. Thin MLF[®] ▲ = Pin 1 identifier.
3. Thin MLF[®] is a GREEN RoHS-compliant package. Lead finish is NiPdAu. Mold compound is Halogen Free.

Pin Configuration

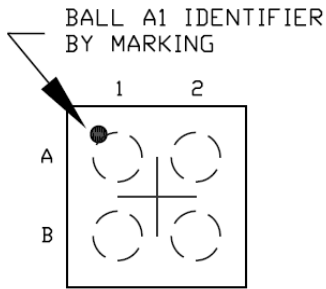

4-Ball 0.88mm × 0.88mm CSP (CS)
Top View

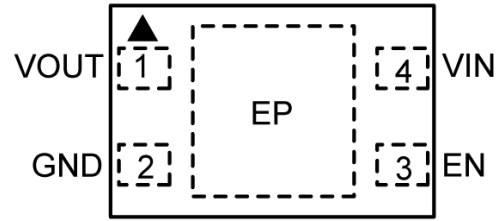

4-Pin 1.2mm × 1.6mm Thin MLF[®] (MT)
Top View

Pin Description

Pin Number (Thin MLF [®])	Ball Number (CSP)	Pin Name	Pin Name
1	A2	VOUT	Power switch output.
2	B2	GND	Ground.
3	B1	EN	Enable input. A logic HIGH signal on this pin enables the part. Logic LOW disables the part. Do not leave floating.
4	A1	VIN	Power switch input and chip supply.
EP	–	ePad	Exposed Heatsink Pad. Connect to Ground for best thermal performance.

Functional Block Diagram

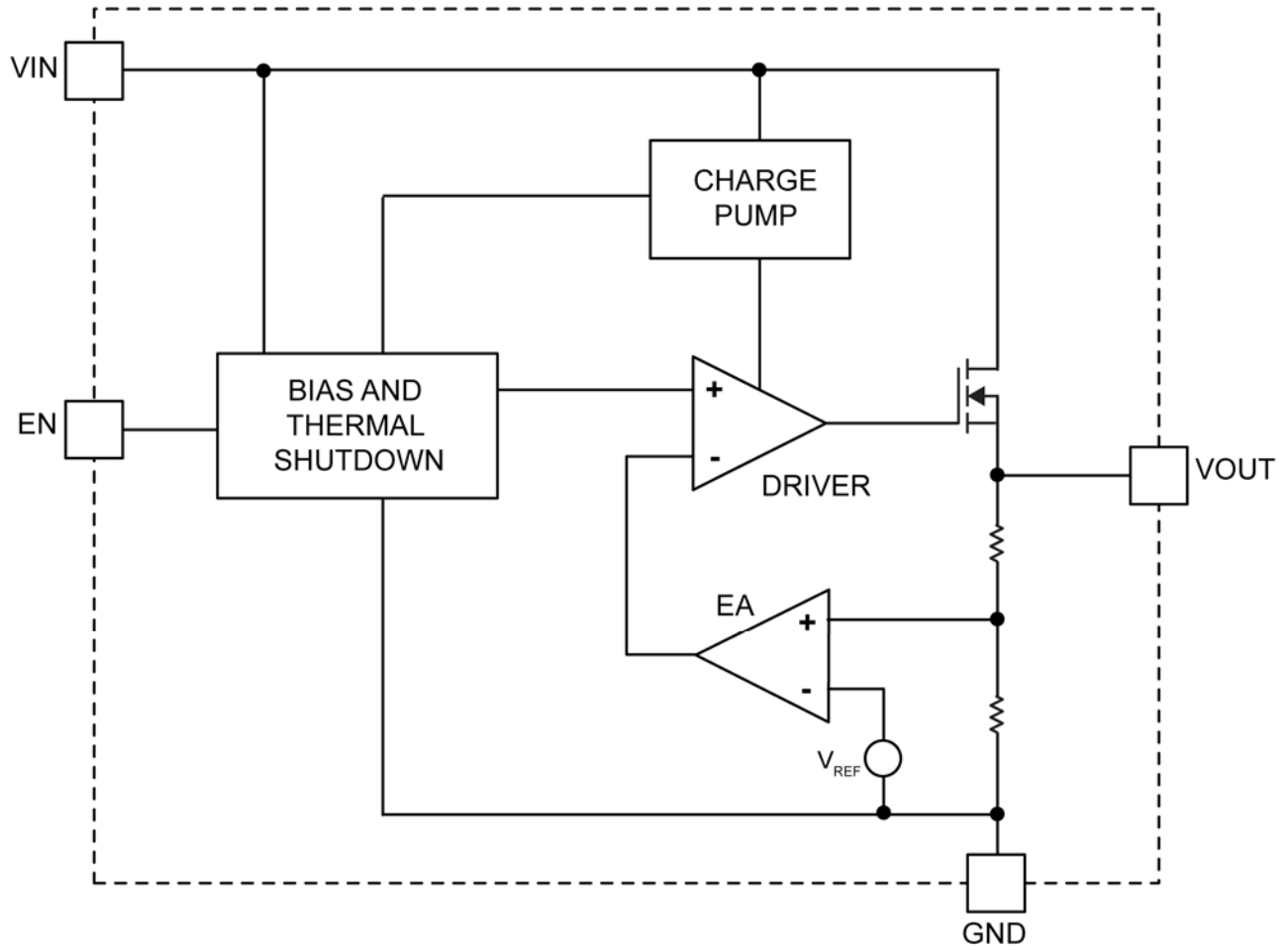

Absolute Maximum Ratings⁽¹⁾

Input Voltage (V_{IN})	-0.3 to +4V
Output Voltage (V_{OUT})	-0.3 to $V_{IN}+0.3V$ or +4V
Enable Voltage (V_{EN})	-0.3 to $V_{IN}+0.3V$ or +4V
Lead Temperature (soldering, 10s)	260°C
Storage Temperature (T_s)	-65°C to +150°C
ESD Rating ⁽³⁾	3kV

Operating Ratings⁽²⁾

Input Voltage (V_{IN})	+1.8V to +3.6V
Enable Voltage (V_{EN})	0V to V_{IN}
Junction Temperature (T_J)	-40°C to +125°C
Junction Thermal Resistance	
Thin MLF [®] (θ_{JA})	173°C/W
CSP (θ_{JA})	250°C/W

Electrical Characteristics⁽⁴⁾

$V_{IN} = V_{EN} = V_{OUT} + 500mV$ ($V_{IN} = V_{EN} = 3.6V$ for $V_{OUT} \geq 3.1V$); $I_{OUT} = 1mA$; $C_{OUT} = 1\mu F$; $T_A = 25^\circ C$,
bold values indicate $-40^\circ C \leq T_J \leq +125^\circ C$, unless noted.

Parameter	Condition	Min.	Typ.	Max.	Units
Input Voltage		1.8		3.6	V
Output Voltage Accuracy	Variation from nominal V_{OUT}	-3	± 1	+3	%
Dropout Voltage	V_{IN} to V_{OUT} dropout at 100mA output current		20	50	mV
	V_{IN} to V_{OUT} dropout at 200mA output current		40	100	
Load Regulation	1mA to 100mA		4		mV
Line Regulation	$V_{IN} = V_{OUT} + 500mV$ to 3.6V		0.01	0.5	%
Ground Current	No load to full load		170	250	μA
Shutdown Current	$V_{EN} = 0V$		0.2	5	μA
V_{IN} Ripple Rejection	$f = 100Hz$, $I_{OUT} = 100mA$		85		dB
	$f = 100kHz$, $I_{OUT} = 100mA$		68		
	$f = 1MHz$, $I_{OUT} = 100mA$		57		
	$f = 10MHz$, $I_{OUT} = 100mA$		50		
Current Limit	$V_{OUT} = 0V$	250	400	700	mA
Total Output Noise	10Hz to 100kHz		83		μV_{RMS}
Turn-On Time			70		μs
Enable					
Input Logic Low				0.4	V
Input Logic High		1.0			V
Input Current			0.01	1	μA

Notes:

- Exceeding the absolute maximum rating may damage the device.
- The device is not guaranteed to function outside its operating rating.
- Devices are ESD sensitive. Handling precautions recommended. Human body model, 1.5k Ω in series with 100pF.
- Specification for packaged product only.

Typical Characteristics

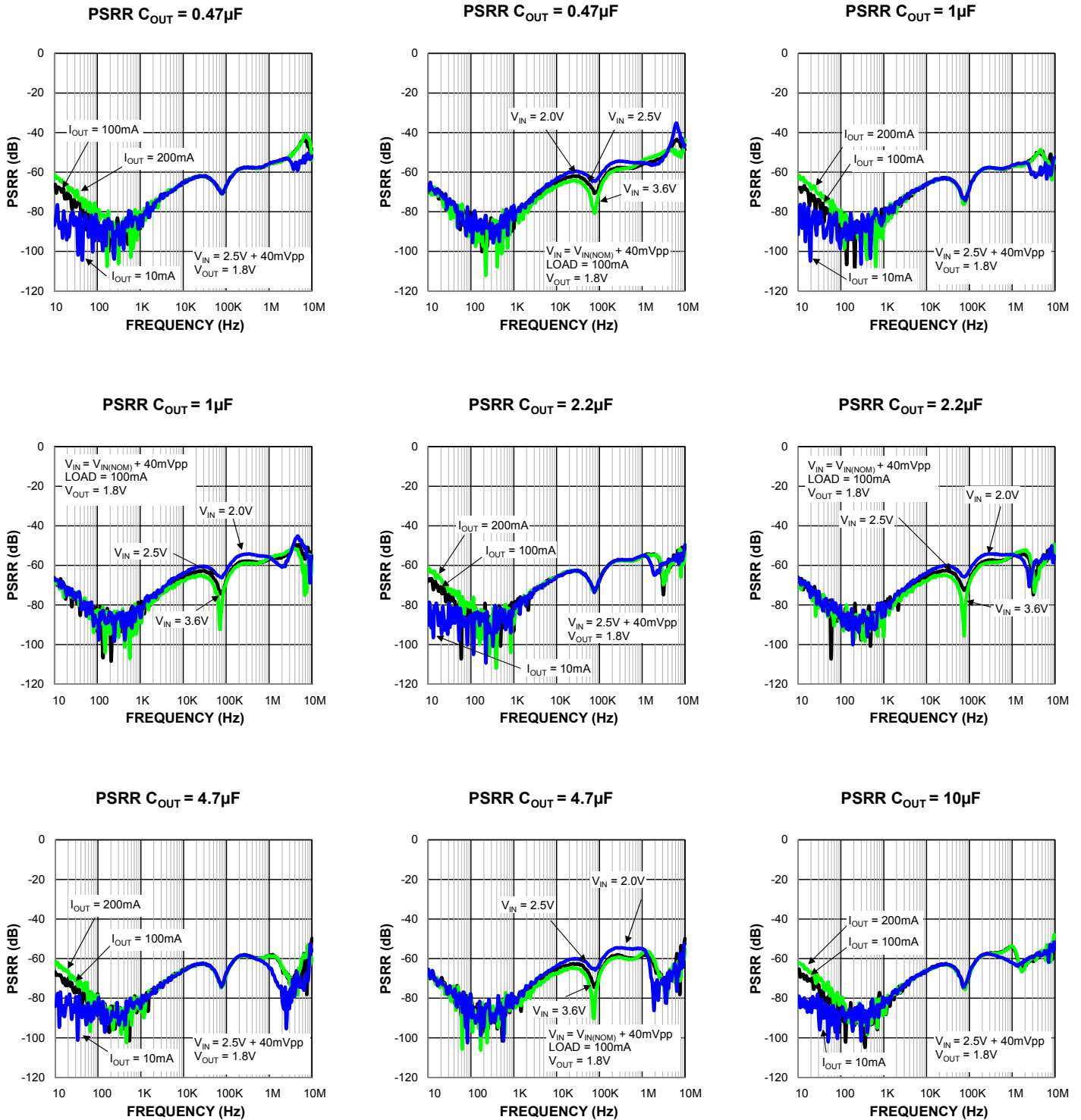

Typical Characteristics (Continued)

PSRR $C_{OUT} = 10\mu F$

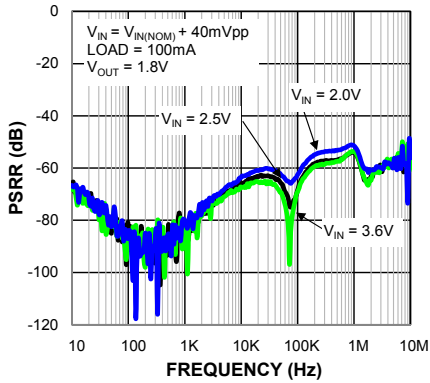

PSRR (Varying C_{OUT})

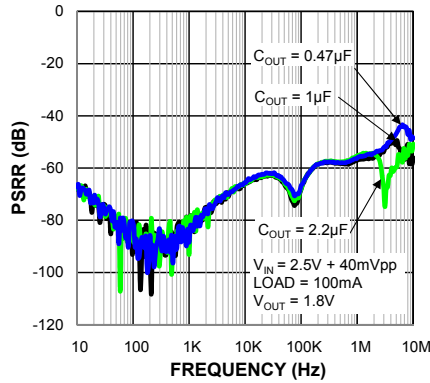

PSRR (Varying C_{OUT})

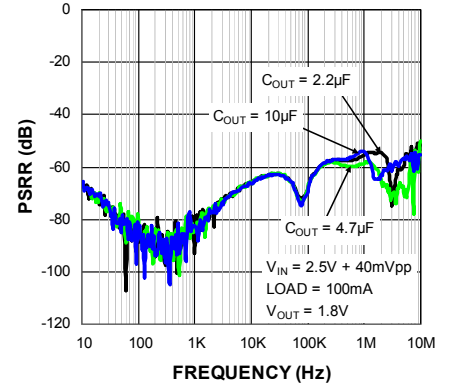

Dropout Voltage vs. Output Current

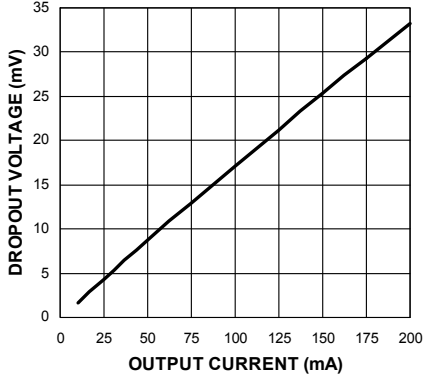

Output Voltage vs. Output Current

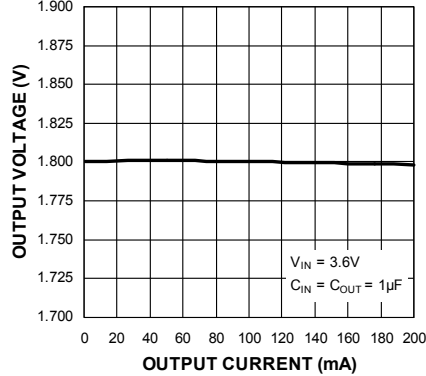

Output Voltage vs. Input Voltage

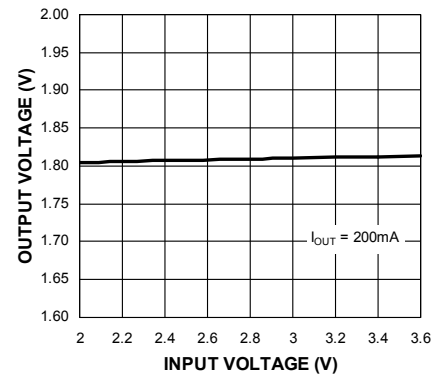

Output Noise Spectral Density

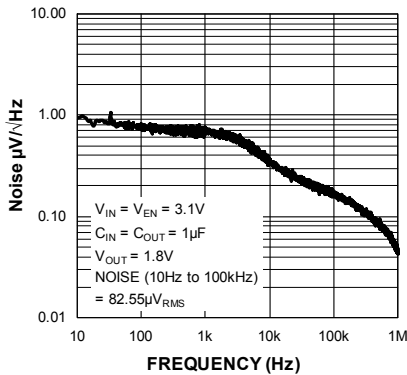

Ground Current vs. Output Current

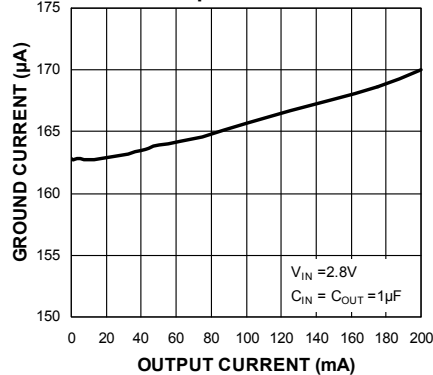

Ground Current vs. Input Voltage

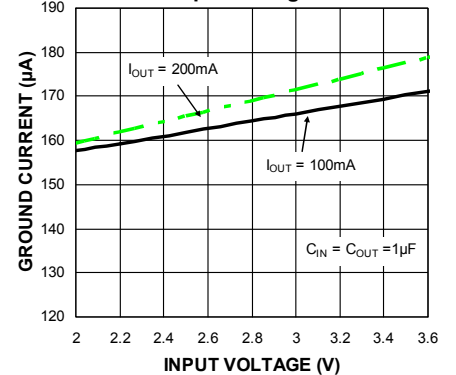

Functional Characteristics

**Load Transient
(0mA to 200mA)**

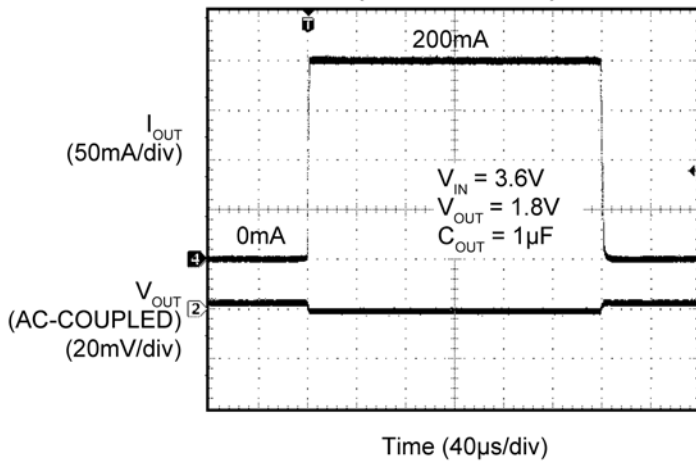

**Line Transient
(2.6V to 3.6V)**

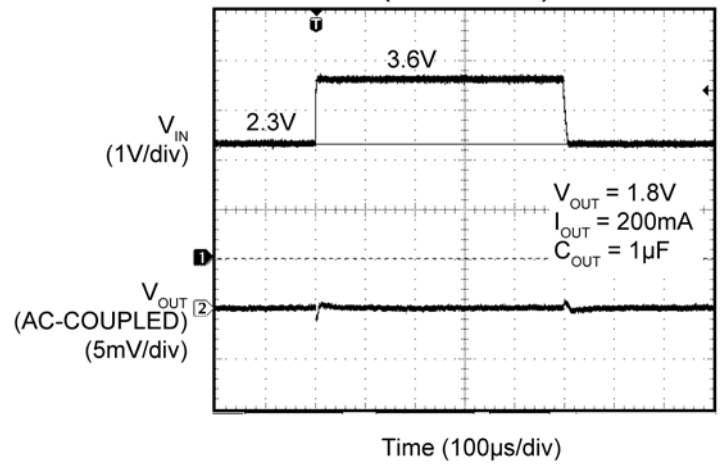

Enable Turn-On

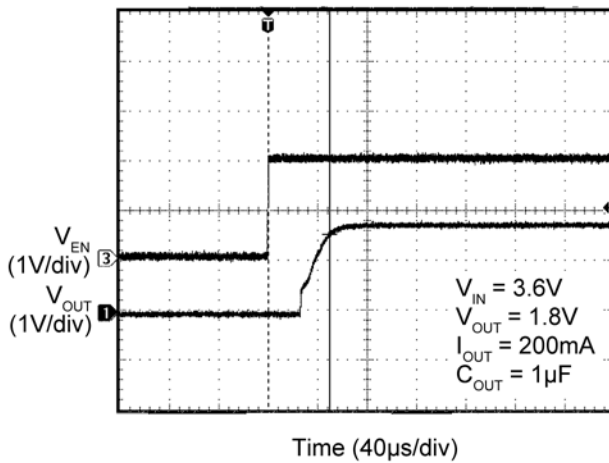

Enable Turn-Off

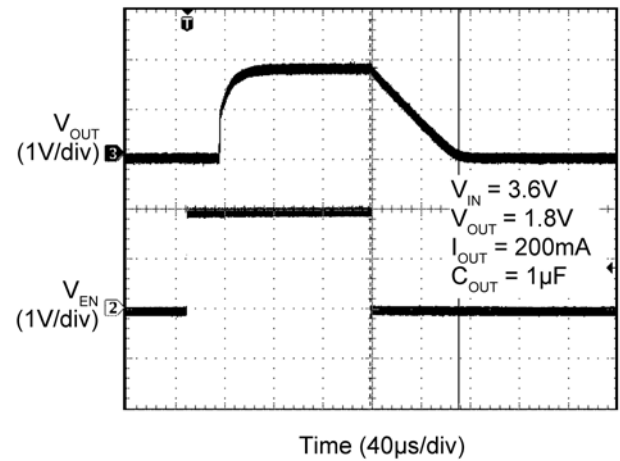

Application Information

The MIC94310 is a very-high PSRR, fixed-output, 200mA LDO utilizing Ripple Blocker™ technology. The MIC94310 is fully protected from damage due to fault conditions, offering linear current limiting and thermal shutdown.

Input Capacitor

The MIC94310 is a high-performance, high-bandwidth device. An input capacitor of 0.47μF is required from the input to ground to provide stability. Low-ESR ceramic capacitors provide optimal performance at a minimum of space. Additional high-frequency capacitors, such as small-valued NPO dielectric-type capacitors, help filter out high-frequency noise and are good practice in any RF-based circuit. X5R or X7R dielectrics are recommended for the input capacitor. Y5V dielectrics lose most of their capacitance over temperature and are therefore, not recommended.

Output Capacitor

In order to maintain stability, the MIC94310 requires an output capacitor of 0.47μF or greater. For optimal ripple rejection performance a 1μF capacitor is recommended. The design is optimized for use with low-ESR ceramic chip capacitors. High-ESR capacitors are not recommended because they may cause high-frequency oscillation. The output capacitor can be increased, but performance has been optimized for a 1μF ceramic output capacitor and does not improve significantly with larger capacitance.

X7R/X5R dielectric type ceramic capacitors are recommended because of their temperature performance. X7R type capacitors change capacitance by 15% over their operating temperature range and are the most stable type of ceramic capacitors. Z5U and Y5V dielectric capacitors change their value by as much as 50% and 60%, respectively, over their operating temperature ranges. To use a ceramic chip capacitor with the Y5V dielectric, the value must be much higher than an X7R ceramic capacitor to ensure the same minimum capacitance over the equivalent operating temperature range.

No Load Stability

The MIC94310 will remain stable and in regulation with no load. This is especially important in CMOS RAM keep-alive applications.

Enable/Shutdown

Forcing the enable (EN) pin low disables the MIC94310 and sends it into a “zero” off mode current state. In this state, current consumed by the MIC94310 goes nearly to zero. Forcing EN high enables the output voltage. The EN pin uses CMOS technology and cannot be left floating as it could cause an indeterminate state on the output.

Thermal Considerations

The MIC94310 is designed to provide 200mA of continuous current in a very-small package. Maximum ambient operating temperature can be calculated based on the output current and the voltage drop across the part. For example if the input voltage is 2.5V, the output voltage is 1.8V, and the output current = 200mA. The actual power dissipation of the Ripple Blocker™ can be determined using the equation:

$$P_D = (V_{IN} - V_{OUT1}) I_{OUT} + V_{IN} I_{GND}$$

Because this device is CMOS and the ground current is typically <170μA over the load range, the power dissipation contributed by the ground current is <1% and can be ignored for this calculation.

$$P_D = (2.5V - 1.8V) \times 200mA$$

$$P_D = 0.14W$$

To determine the maximum ambient operating temperature of the package, use the junction-to-ambient thermal resistance of the device and the following basic equation:

$$P_{D(MAX)} = \left(\frac{T_{J(max)} - T_A}{\theta_{JA}} \right)$$

$T_{J(max)} = 125^\circ\text{C}$, the maximum junction temperature of the die, θ_{JA} thermal resistance = 173°C/W for the Thin MLF® package.

Substituting P_D for $P_{D(MAX)}$ and solving for the ambient operating temperature will give the maximum operating conditions for the regulator circuit.

The maximum power dissipation must not be exceeded for proper operation.

For example, when operating the MIC94310-GYMT at an input voltage of 2.5V and 200mA load with a minimum footprint layout, the maximum ambient operating temperature T_A can be determined as follows:

$$0.14W = (125^{\circ}\text{C} - T_A)/(173^{\circ}\text{C/W})$$
$$T_A = 101^{\circ}\text{C}$$

Therefore, the maximum ambient operating temperature allowed in a 1.2mm x 1.6mm Thin MLF[®] package is 101°C. For a full discussion of heat sinking and thermal effects on voltage regulators, refer to the “Regulator Thermals” section of *Micrel's Designing with Low-Dropout Voltage Regulators* handbook. This information can be found on Micrel's website at:

http://www.micrel.com/PDF/other/LDOBk_ds.pdf

For more information about Micrel's Ripple Blocker™ products, go to:

<http://www.micrel.com/rippleblocker/>

<http://www.micrel.com/page.do?page=/product-info/products/mic94300.jsp>

<http://www.micrel.com/page.do?page=/product-info/products/mic94310.jsp>

Evaluation Board Schematic

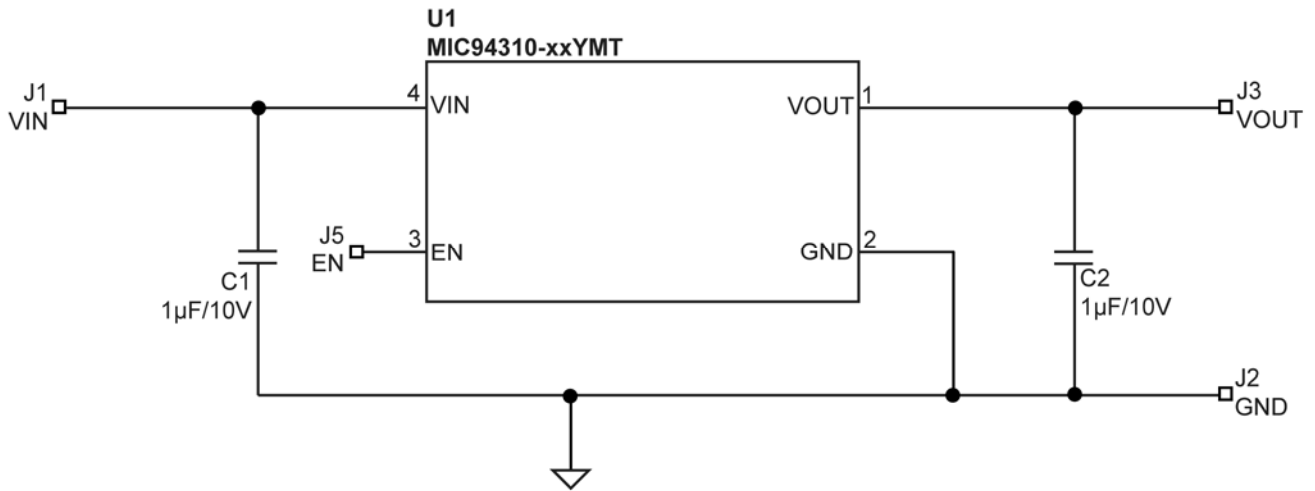

Bill of Materials

Item	Part Number	Manufacturer	Description	Qty.
C1, C2	GRM155R61A105KE15D	Murata ⁽¹⁾	Capacitor, 1µF Ceramic, 10V, X7R, Size 0402	2
U1	MIC94310xx-YMT	Micrel, Inc. ⁽²⁾	200mA Ripple Blocker™ with Fixed Output Voltage	1

Notes:

1. Murata Tel: www.murata.com.
2. Micrel, Inc.: www.micrel.com.

Package Information¹

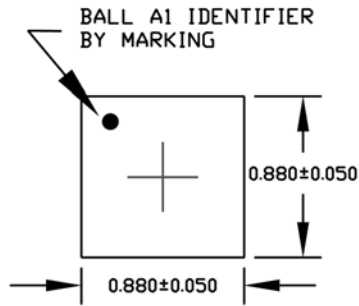

TOP VIEW

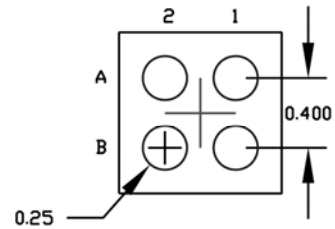

BOTTOM VIEW

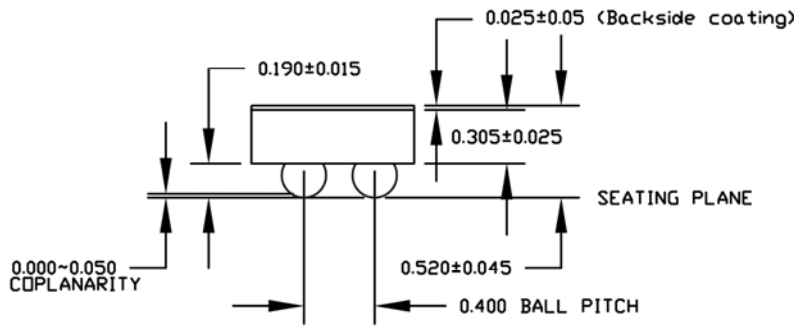

SIDE VIEW

4-Ball 0.88mm × 0.88mm WL-CSP (CS)

Note:

1. Package information is correct as of the publication date. For updates and most current information, go to www.micrel.com.

Package Information¹ (Continued)

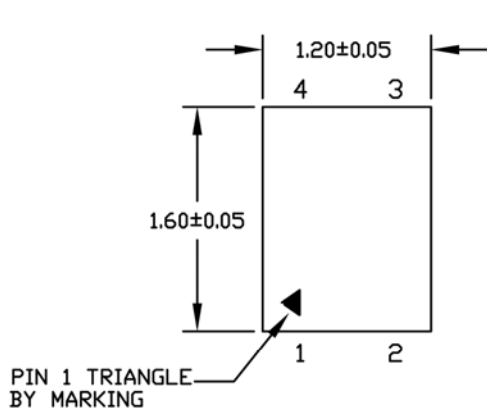

TOP VIEW

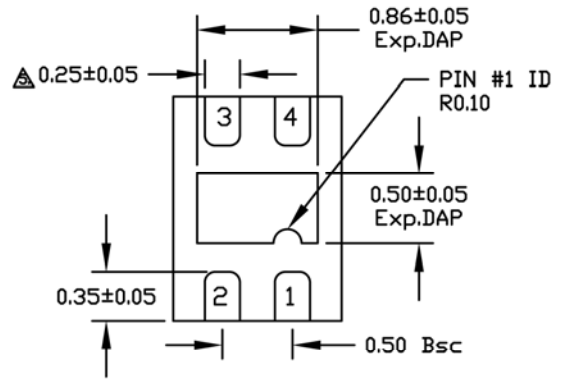

BOTTOM VIEW

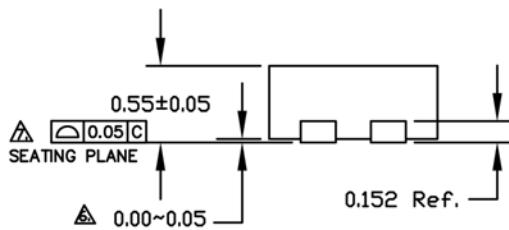

SIDE VIEW

4-Pin 1.2mm × 1.6mm Thin MLF[®] (MT)

MICREL, INC. 2180 FORTUNE DRIVE SAN JOSE, CA 95131 USA
 TEL +1 (408) 944-0800 FAX +1 (408) 474-1000 WEB <http://www.micrel.com>

Micrel makes no representations or warranties with respect to the accuracy or completeness of the information furnished in this data sheet. This information is not intended as a warranty and Micrel does not assume responsibility for its use. Micrel reserves the right to change circuitry, specifications and descriptions at any time without notice. No license, whether express, implied, arising by estoppel or otherwise, to any intellectual property rights is granted by this document. Except as provided in Micrel's terms and conditions of sale for such products, Micrel assumes no liability whatsoever, and Micrel disclaims any express or implied warranty relating to the sale and/or use of Micrel products including liability or warranties relating to fitness for a particular purpose, merchantability, or infringement of any patent, copyright or other intellectual property right.

Micrel Products are not designed or authorized for use as components in life support appliances, devices or systems where malfunction of a product can reasonably be expected to result in personal injury. Life support devices or systems are devices or systems that (a) are intended for surgical implant into the body or (b) support or sustain life, and whose failure to perform can be reasonably expected to result in a significant injury to the user. A Purchaser's use or sale of Micrel Products for use in life support appliances, devices or systems is a Purchaser's own risk and Purchaser agrees to fully indemnify Micrel for any damages resulting from such use or sale.

© 2012 Micrel, Incorporated.