

SFMC28-461 EMI Input Filters

28 VOLT INPUT – 2.7 AMP

FEATURES

Attenuation 60 dB at 500 kHz, typical

- Operating temperature -55° to +125°C
- Qualified to MIL-PRF-38534 Class H and K
- Passive components used for maximum tolerance in space environments
- Nominal 28 V input, 0 V to 50 V operation
- Up to 2.7 A throughput current
- Compliant to MIL-STD-461C CE-03
- Compatible with MIL-STD-704 B-E 28 VDC power bus



INPUT VOLTAGE AND CURRENT

Input (V)	Current (A)
28	2.7

DESCRIPTION

The SFMC28-461™ EMI filters provide an off-the-shelf filtering solution compliant to MIL-PRF-38534, Class H or Class K, for use in your space system. SFMC28-461 filters reduce the input line reflected ripple current of our switching DC/DC converters. Use an SFMC28-461 filter with our SMTR, SMHF and SMSA series of DC/DC converters to meet MIL-STD-461C levels of conducted emission (CE01, CE03). The SFMC filters are designed exclusively with passive components providing maximum tolerance for space environments.

SCREENING

The SFMC28-461 EMI filters offer environmental screening levels to Space Prototype (O), Class H, or Class K requirements. Radiation tolerant to Radiation Hardness Assurance (RHA) levels of “-” (O) or “H”, per MIL-PRF-38534. Interpoint model numbers use an “O” in the RHA designator position to indicate the “-” (dash) Radiation Hardness Assurance level of MIL-PRF-38534, which is defined as “no RHA”. See Screening Tables 1, 2 and 3 for more information.

RIPPLE REDUCTION

The SFMC28-461 EMI filter, when used with Interpoint's converters, reduces reflected input ripple current by a minimum of 55 dB at 500 kHz and 60 dB at 1 MHz. The filter and converter combination performance exceeds the CEO3 requirements of MIL-STD-461C.

INSERTION LOSS

The maximum DC insertion loss for the SFMC28-461 filter (at a load of 22 watts) represents a power loss of less than 2% at nominal input voltage.

FILTER DESIGN

SFMC28-461 filters incorporate thick-film hybrid technology and use only high quality ceramic capacitors for reliable high temperature operation.

All SFMC28-461 filters are built to the same assembly drawing regardless of environmental screening or radiation tolerance level. Filters designated level OO, indicating standard environmental screening, are electrically comparable to filters designated level KH, the highest environmental screening level. This ensures consistency between your prototype or test system using level OO filters and your flight system using filters with higher levels of environmental screening and radiation tolerance. Element evaluation (screening at the component level) of Class H or Class K filters ensures even greater reliability. Refer to Table 1, 2 and 3 for more information.

OPERATING TEMPERATURE

The filter operates at full load over the temperature range of -55°C to +125°C case. Above +125°C, the current must be derated as specified on page two.

PACKAGING

SFMC28-461 EMI filters are encased in high-reliability, hermetically-sealed metal packages and weigh just 48 grams. A small footprint of 2.100 inches (53.34 mm) by 1.115 inches (28.32 mm) by 0.400 inches (10.16 mm) minimizes the board area needed for the filter.

SFMC28-461 EMI Input Filters

28 VOLT INPUT – 2.7 AMP

OPERATING CONDITIONS AND CHARACTERISTICS

Input Voltage Range

- 0 to 50 VDC continuous

Lead Soldering Temperature (10 sec per pin)

- 300°C

Storage Temperature Range (T_C)

- 65°C to +150°C

Case Operating Temperature (T_C)

- -55°C to +125°C full power

Derating Output Power/Current

- Derate linearly from 100% at 125°C to 0% at 135°C case

Isolation ($T_C = 25^\circ\text{C}$)

- 100 megohm minimum at 500 VDC
- Any pin to case, except case pin

MECHANICAL AND ENVIRONMENTAL

Size (maximum)

- Non-flanged
 - 2.100 x 1.115 x 0.400 (53.34 x 28.32 x 10.16 mm)
 - See case H1 for dimensions
- Flanged
 - 2.910 x 1.115 x 0.400 inches (73.91 x 28.32 x 10.16 mm)
 - See case K2 for dimensions

Weight (maximum)

- 48 grams typical

Screening

- Space Prototype (O), Class H, or Class K.
- Radiation tolerant to Radiation Hardness Assurance (RHA) levels of “-” (O) or “H”, per MIL-STD-38534. Interpoint model numbers use an “O” in the RHA designator position to indicate the “-” (dash) Radiation Hardness Assurance level of MIL-PRF-38534, which is defined as “no RHA”.
- See Screening Tables 1, 2 and 3 for more information.
Available configurations: OO, HH, KH

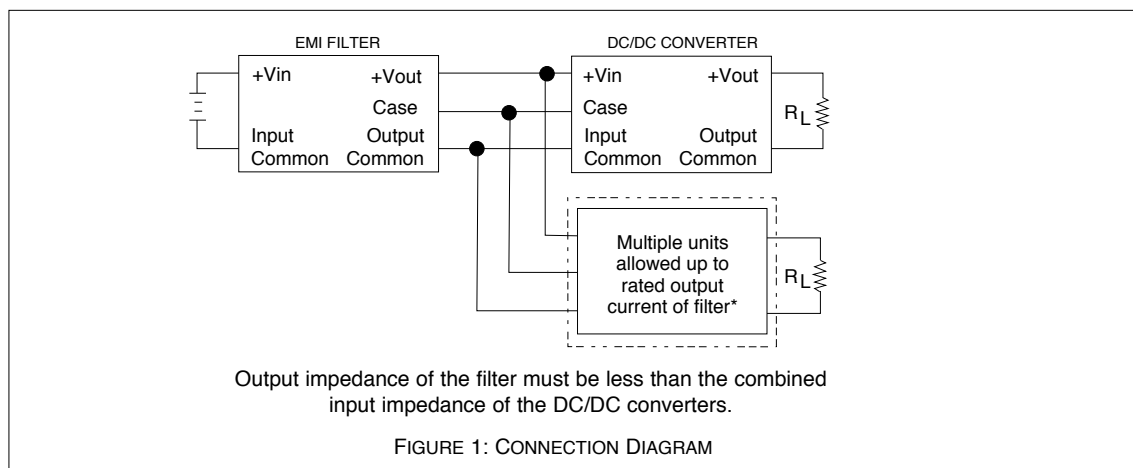

SFMC28-461 EMI Input Filters

28 VOLT INPUT – 2.7 AMP

PIN OUT	
Pin	Designation
1	Positive Input
2	Positive Output
3	Case Ground
4	Output Common
5	Input Common

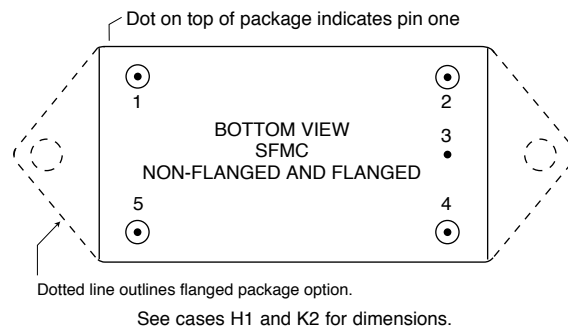
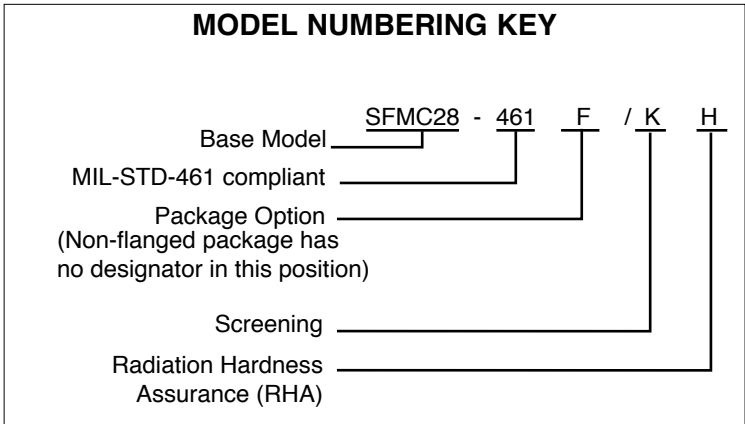

FIGURE 2: PIN OUT

SFMC28-461 EMI Input Filters

28 VOLT INPUT – 2.7 AMP



DSCC NUMBERS	
DSCC DRAWING (5915)	SFMC28-461 SIMILAR PART
94010H02HXC	SFMC28-461/HH
94010H02HXC	SFMC28-461F/HH
94010H02HXC	SFMC28-461/KH
94010H02HXC	SFMC28-461F/KH
For exact specifications for a DSCC product, refer to the DSCC drawing. DSCC drawings can be downloaded from: http://www.dscclia.mil/programs/smcr	

MODEL SELECTION				
ON THE LINES BELOW, ENTER ONE SELECTION FROM EACH CATEGORY TO DETERMINE THE MODEL NUMBER.				
CATEGORY	SFMC28-461 Base Model and Input Voltage	_____ / _____ Case Option ¹	_____ / _____ Screening ²	_____ / _____ RHA ³
SELECTION	SFMC28-461 is the only available selection	(STANDARD, leave blank) F (flanged)	O H K	O H
Notes: 1. Case Options: For the standard case, case H1, leave the case option blank. For the flanged case option, case K2, insert the letter F in the Case Option position. 2. Screening: A screening level of O is a Space Prototype and is only used with RHA O. See Screening Tables 2 and 3 for more information. "H" indicates Class H and "K" indicates Class K of MIL-PRF-38534. 4. RHA: Interpoint model numbers use an "O" in the RHA designator position to indicate the "-" (dash) Radiation Hardness Assurance level of MIL-PRF-38534, which is defined as "no RHA." RHA O is only available with Screening level O. See Screening Table 3 for more information.				

SFMC28-461 EMI Input Filters

28 VOLT INPUT – 2.7 AMP

Electrical Characteristics: -55° to +125°C T_C, nominal V_{in} unless otherwise specified.

MODEL		SFMC28-461			UNITS
PARAMETER	CONDITIONS	MIN	TYP	MAX	
INPUT VOLTAGE	CONTINUOUS	0	28	50	VDC
NOISE REJECTION	500 KHZ	55	60	—	dB
	1 MHZ	60	—	—	
	5 MHZ	60	—	—	
DC RESISTANCE (R _{DC})	25°C	—	—	0.2	Ω
OUTPUT VOLTAGE ²	STEADY STATE	V _{OUT} = V _{IN} - I _{IN} (R _{DC})			VDC
CAPACITANCE	ANY PIN TO CASE T _C = 25°C	—	—	48,000	pF
OUTPUT CURRENT	STEADY STATE	—	—	2.7	A
REFLECTED RIPPLE CURRENT ¹	FROM CONVERTER TO FILTER	—	—	1.0	A _{RMS}
POWER DISSIPATION ¹ AT MAXIMUM CURRENT		—	—	1.5	W

Notes

1. **Guaranteed by design, not tested.**

2. Typical applications result in V_{out} within 2% of V_{in}.

SFMC28-461 EMI Input Filters

28 VOLT INPUT – 2.7 AMP

Typical Performance Curves: 25°C Tc , nominal Vin, unless otherwise specified.

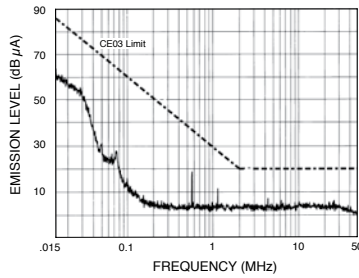

DC/DC Converter Typical Worst Case
EMI With SFMC-461 Filter
FIGURE 3

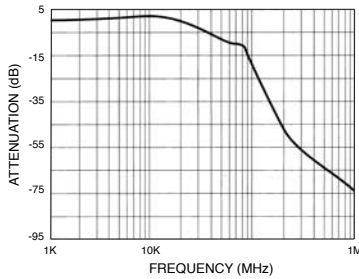

SFMC-461 Typical Amplitude
Response vs. Frequency
FIGURE 4

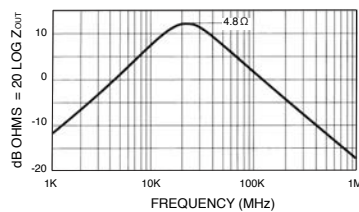

Typical Output Impedance (Z)
With Input Shorted
FIGURE 5

SFMC28-461 EMI Input Filter Cases

28 VOLT INPUT – 2.7 AMP

BOTTOM VIEW CASE H1

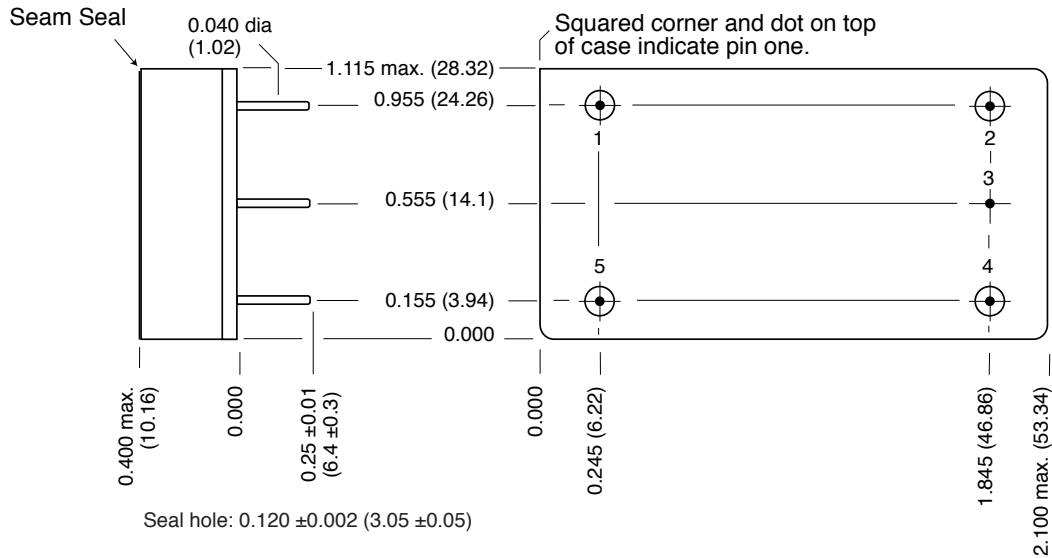

Case dimensions in inches (mm)

Tolerance ± 0.005 (0.13) for three decimal places
 ± 0.01 (0.3) for two decimal places
 unless otherwise specified

CAUTION

Heat from reflow or wave soldering may damage the device.
 Solder pins individually with heat application not exceeding 300°C for 10 seconds per pin.

Materials

Header Cold Rolled Steel/Nickel/Gold
 Cover Kovar/Nickel
 Pins #52 alloy/Gold, ceramic seal
 Seal hole 0.120 ±0.002 (3.05 ± 0.05)

Case H1 Filters, Rev F, 20100429
 Please refer to the numerical dimensions for accuracy.

FIGURE 6: CASE H1

SFMC28-461 EMI Input Filter Cases

28 VOLT INPUT – 2.7 AMP

BOTTOM VIEW CASE K2

Flanged cases: Designator "F" required in Case Option position of model number.

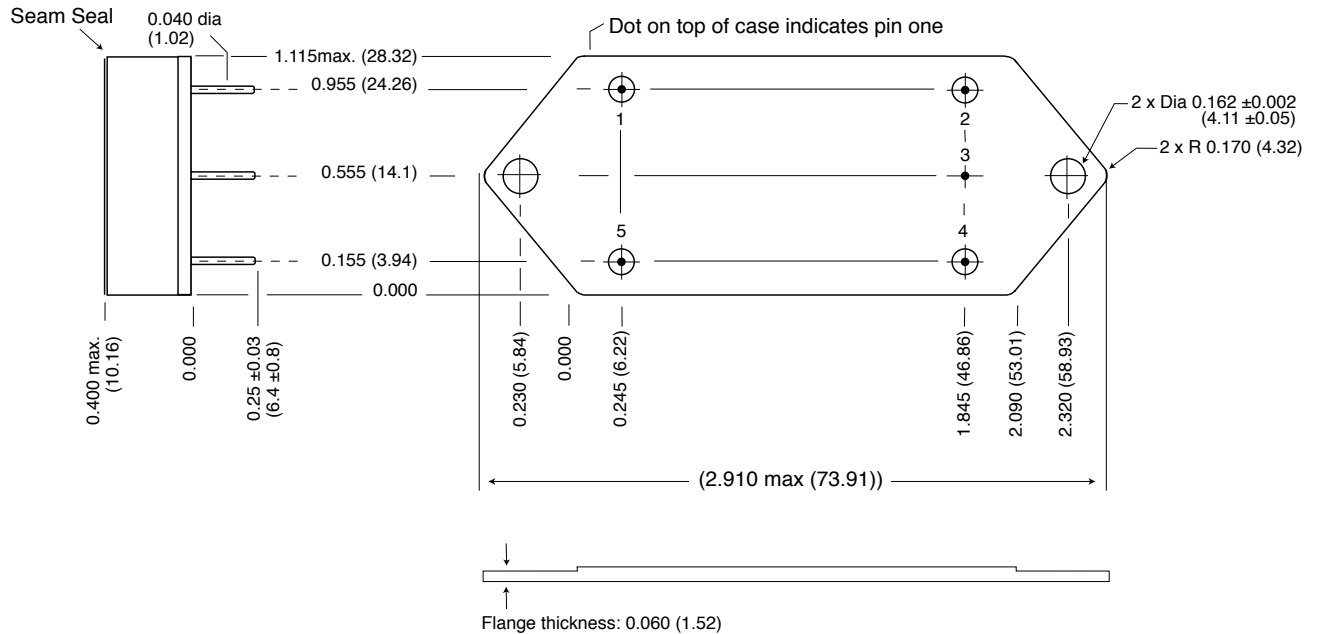

Case dimensions in inches (mm)

Tolerance ± 0.005 (0.13) for three decimal places
 ± 0.01 (0.3) for two decimal places
 unless otherwise specified

CAUTION

Heat from reflow or wave soldering may damage the device. Solder pins individually with heat application not exceeding 300°C for 10 seconds per pin.

Materials

Header Cold Rolled Steel/Nickel/Gold
 Cover Kovar/Nickel
 Pins #52 alloy/Gold, ceramic seal.
 Seal Hole: 0.120 ±0.002 (3.04 ±0.05)

Case K2 SFMC F, Rev F, 20100506

FIGURE 7: CASE K2

SFMC28-461 EMI Input Filters

28 VOLT INPUT – 2.7 AMP

CLASS H AND K, MIL-PRF-38534 ELEMENT EVALUATION

COMPONENT-LEVEL TEST PERFORMED	SPACE PROTOTYPE (O) NON-QML ¹		CLASS H QML		CLASS K QML	
	M/S ²	P ³	M/S ²	P ³	M/S ²	P ³
Element Electrical	yes	no	yes	yes	yes	yes
Element Visual	no	no	yes	yes	yes	yes
Internal Visual	no	N/A	yes	N/A	yes	N/A
Temperature Cycling	no	no	no	no	yes	yes
Constant Acceleration	no	no	no	no	yes	yes
Interim Electrical	no	N/A	no	N/A	yes	N/A
Burn-in	no	N/A	no	N/A	yes	N/A
Post Burn-in Electrical	no	N/A	no	N/A	yes	N/A
Steady State Life	no	N/A	no	N/A	yes	N/A
Voltage Conditioning Aging	N/A	no	N/A	no	N/A	yes
Visual Inspection	no	no	N/A	no	N/A	yes
Final Electrical	no	no	yes	yes	yes	yes
SEM	no	N/A	no	N/A	yes	N/A
SLAM™/C-SAM: Input capacitors only (Add'l test, not req. by H or K)	no	no	no	yes	no	yes

Notes:

1. Non-QML products do not meet all of the requirements of MIL-PRF-38534.
2. M/S = Active components (Microcircuit and Semiconductor Die)
3. P = Passive components

Definitions:

Element Evaluation: Component testing/screening per MIL-STD-883 as determined by MIL-PRF-38534

SEM: Scanning Electron Microscopy

SLAM™: Scanning Laser Acoustic Microscopy

C-SAM: C - Mode Scanning Acoustic Microscopy

SCREENING TABLE 1: ELEMENT EVALUATION

SFMC28-461 EMI Input Filters

28 VOLT INPUT – 2.7 AMP

CLASS H AND K, MIL-PRF-38534 ENVIRONMENTAL SCREENING

END ITEM-LEVEL TEST PERFORMED	SPACE PROTOTYPE (O) NON-QML ¹	CLASS H QML	CLASS K QML
Pre-cap Inspection Method 2017, 2032	yes	yes	yes
Temperature Cycle (10 times) Method 1010, Cond. C, -65°C to 150°C, ambient	yes	yes	yes
Constant Acceleration Method 2001, 3000 g	yes	yes	yes
PIND Test Method 2020, Cond. A	no	yes ²	yes
Pre burn-in test	yes	yes	yes
Burn-in Method 1015, 125°C case, typical			
96 hours	yes	no	no
160 hours	no	yes	no
2 x 160 hours (includes mid-BI test)	no	no	yes
Final Electrical Test MIL-PRF-38534 Group A, Subgroups 1 through 6 -55°C, +25°C, +125°C case	yes	yes	yes
Radiography Method 2012	N/A	N/A	yes
Post Radiography Electrical Test Room temperature	N/A	N/A	yes ²
Hermeticity Test Fine Leak, Method 1014, Cond. A	yes	yes	yes
Gross Leak, Method 1014, Cond. C	yes	yes	yes
Final visual inspection Method 2009	yes	yes	yes

Test methods are referenced to MIL-STD-883 as determined by MIL-PRF-38534.

Notes:

1. Space Prototype (O), non-QML products, do not meet all of the requirements of MIL-PRF-38534.
2. Not required by DSCC but performed to assure product quality.

SCREENING TABLE 2: ENVIRONMENTAL SCREENING

SFMC28-461 EMI Input Filters

28 VOLT INPUT – 2.7 AMP

CLASS H AND K, MIL-PRF-38534 RADIATION HARDNESS ASSURANCE (RHA)

RADIATION HARDNESS ASSURANCE LEVELS	ENVIRONMENTAL SCREENING LEVELS		
	SPACE PROTOTYPE (O) NON-QML ¹	CLASS H QML	CLASS K QML
O ² Standard, no radiation guarantee	OO	N/A	N/A
H ³ Radiation tolerant– Tested lots up to 1,000 kRads (Si) total dose, applies to EMI filters only	N/A	HH	KH

Notes:

1. Space Prototype (O), non-QML, products do not meet all of the requirements of MIL-PRF-38534.
2. Interpoint model numbers use an "O" in the RHA designator position to indicate the "-" (dash) Radiation Hardness Assurance level of MIL-PRF-38534, which is defined as "no RHA"
3. Our EMI filters are designed exclusively with passive components providing maximum tolerance for space environment requirements.

SCREENING TABLE 3: RADIATION HARDNESS ASSURANCE