

SFH620-1X, SFH620-2X, SFH620-3X
SFH620-1, SFH620-2, SFH620-3



**AC INPUT PHOTOTRANSISTOR
OPTICALLY COUPLED ISOLATORS**

APPROVALS

- UL recognised, File No. E91231
- **'X' SPECIFICATION APPROVALS**
- Certified to EN60950 by the following Test Bodies :-
Nemko - Certificate No. P96102022
Fimko - Registration No. 192313-01..25
Semko - Reference No. 9639052 01
Demko - Reference No. 305969
- VDE 0884 approval pending

DESCRIPTION

The SFH620 series of optically coupled isolators consist of inverse parallel infrared light emitting diodes and NPN silicon photo transistors in space efficient dual in line plastic packages.

FEATURES

- Options :-
10mm lead spread - add G after part no.
Surface mount - add SM after part no.
Tape&reel - add SMT&R after part no.
- Low input current $\pm 1\text{mA } I_F$
- High Current Transfer Ratios
- High Isolation Voltage ($5.3\text{kV}_{\text{RMS}}, 7.5\text{kV}_{\text{PK}}$)
- High BV_{CEO} (70V min)
- AC or polarity insensitive input
- All electrical parameters 100% tested
- Custom electrical selections available

APPLICATIONS

- Computer terminals
- Industrial systems controllers
- Measuring instruments
- Telephone sets, Telephone exchanges
- Signal transmission between systems of different potentials and impedances

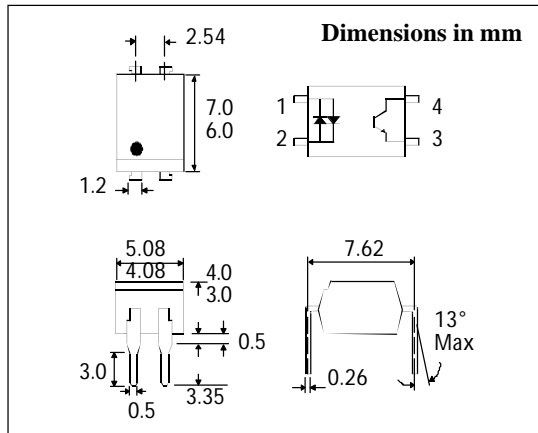
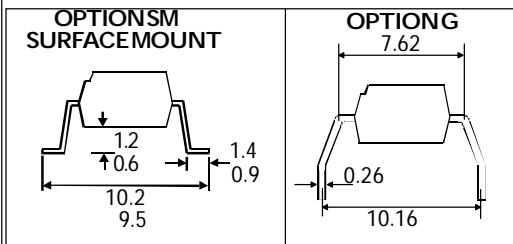

**ABSOLUTE MAXIMUM RATINGS
(25°C unless otherwise specified)**

Storage Temperature	-55°C to +125°C
Operating Temperature	-55°C to +100°C
Lead Soldering Temperature (1/16 inch (1.6mm) from case for 10 secs)	260°C

INPUT DIODE

Forward Current	$\pm 50\text{mA}$
Power Dissipation	70mW

OUTPUT TRANSISTOR

Collector-emitter Voltage BV_{CEO}	70V
Emitter-collector Voltage BV_{ECO}	6V
Power Dissipation	150mW

POWER DISSIPATION

Total Power Dissipation	200mW
(derate linearly 2.67mW/°C above 25°C)	

ISOCOM COMPONENTS LTD
Unit 25B, Park View Road West,
Park View Industrial Estate, Brenda Road
Hartlepool, Cleveland, TS25 1YD
Tel: (01429) 863609 Fax : (01429) 863581

ISOCOM INC
720 E., Park Boulevard, Suite 104,
Plano, TX 75074 USA
Tel: (972) 423-5521
Fax: (972) 422-4549

ELECTRICAL CHARACTERISTICS ($T_A = 25^\circ\text{C}$ Unless otherwise noted)

PARAMETER		MIN	TYP	MAX	UNITS	TEST CONDITION
Input	Forward Voltage (V_F)			1.65	V	$I_F = \pm 50\text{mA}$
Output	Collector-emitter Breakdown (BV_{CEO}) (Note 2)	70			V	$I_C = 1\text{mA}$
	Emitter-collector Breakdown (BV_{ECO})	6			V	$I_E = 100\mu\text{A}$
	Collector-emitter Dark Current (I_{CEO}) SFH620-1,2 SFH620-3			50 100	nA nA	$V_{CE} = 10\text{V}$
Coupled	Current Transfer Ratio (CTR) (Note 2) SFH620-1 SFH620-2 SFH620-3	40		125	%	$\pm 10\text{mA } I_F, 5\text{V } V_{CE}$
		63		200	%	
		100		320	%	
	SFH620-1 SFH620-2 SFH620-3	13			%	$\pm 1\text{mA } I_F, 5\text{V } V_{CE}$
		22			%	
		34			%	
	Collector-emitter Saturation Voltage V_{CESAT}			0.4	V	$\pm 10\text{mA } I_F, 2.5\text{mA } I_C$
Input to Output Isolation Voltage V_{ISO}	5300 7500			V_{RMS} V_{PK}	See note 1 See note 1	
Input-output Isolation Resistance R_{ISO}	5×10^{10}			Ω	$V_{IO} = 500\text{V}$ (note 1)	

Note 1 Measured with input leads shorted together and output leads shorted together.

Note 2 Special Selections are available on request. Please consult the factory.

SWITCHING CHARACTERISTICS

1. Linear Operation (without saturation) Fig 1.
 $I_F = 10\text{mA}$, $V_{CC} = 5\text{V}$, $R_L = 75\Omega$, $T_A = 25^\circ\text{C}$

		UNITS
Turn-on Time	t_{on}	μs
Rise Time	t_r	μs
Turn-off Time	t_{off}	μs
Fall Time	t_f	μs
Cut-off Frequency	F_{CO}	kHz

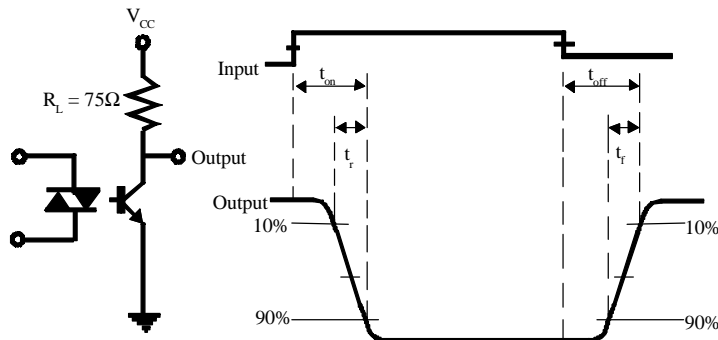
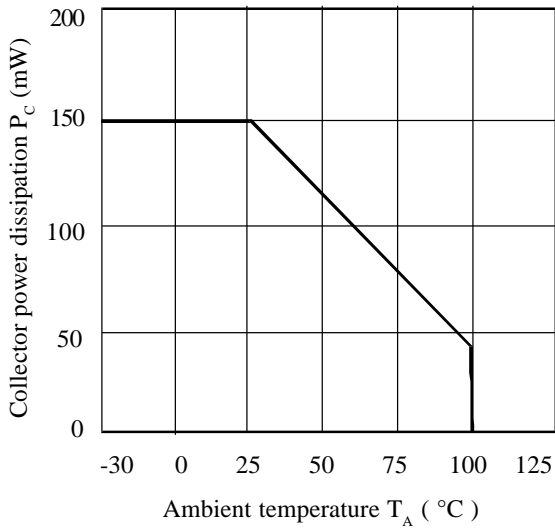
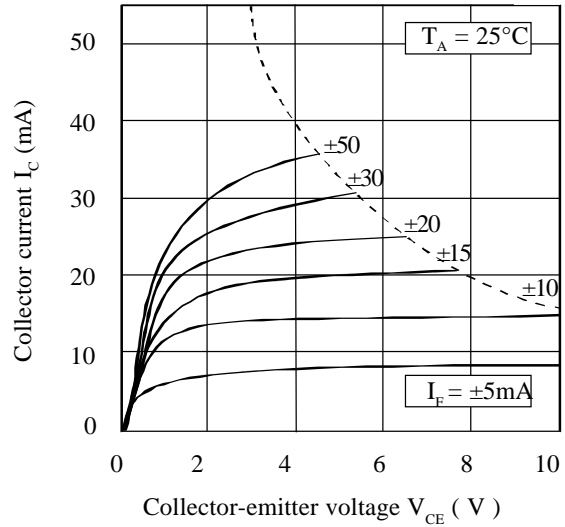

FIG 1

Collector Power Dissipation vs. Ambient Temperature



Collector Current vs. Collector-emitter Voltage (normalized to SFH620-2 & SFH620-3)



Forward Current vs. Ambient Temperature

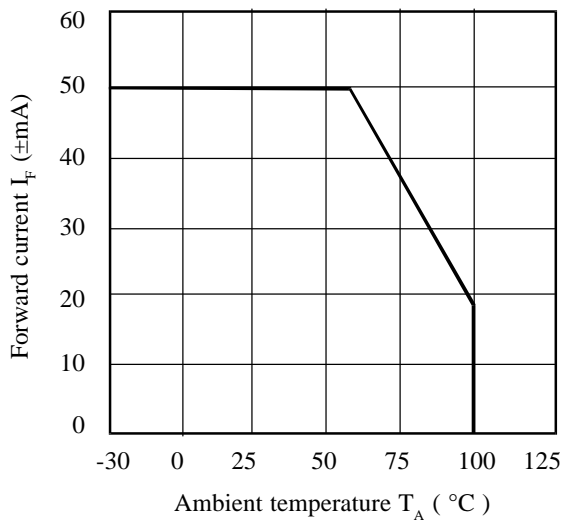

Current Transfer Ratio vs. Forward Current

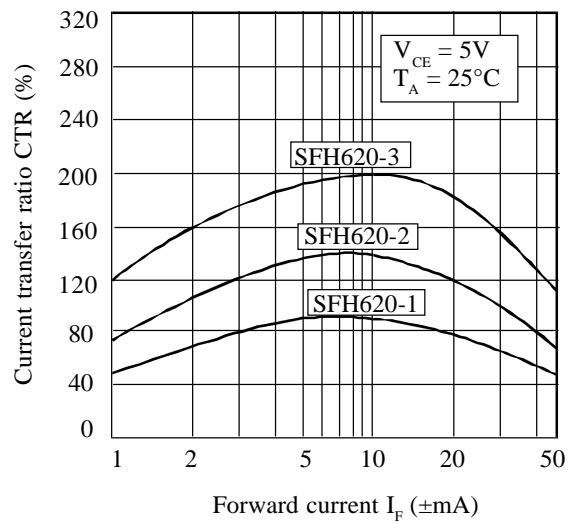

Relative Current Transfer Ratio vs. Ambient Temperature

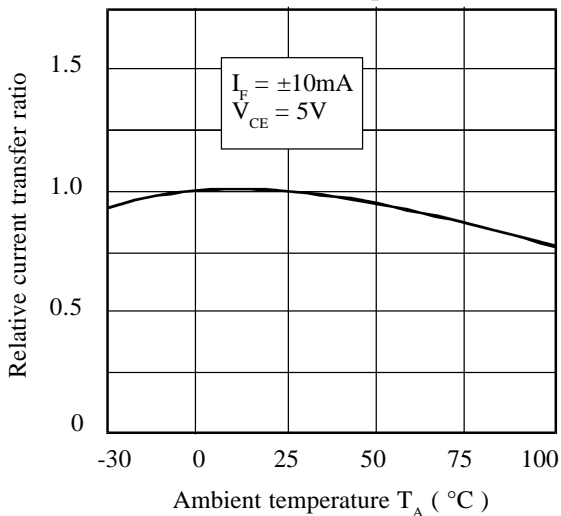

Collector-emitter Saturation Voltage vs. Ambient Temperature

