

IR-Lumineszenzdiode (880 nm) im TO-46-Gehäuse
Infrared Emitter (880 nm) in TO-46 Package
Lead (Pb) Free Product - RoHS Compliant

SFH 4881
SFH 4883

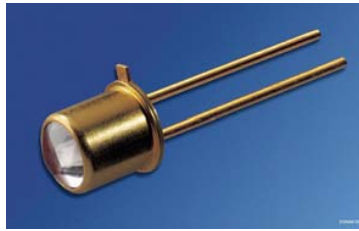

SFH 4881



SFH 4883

Wesentliche Merkmale

- Hergestellt im Schmelzepitaxieverfahren
- Anode galvanisch mit dem Gehäuseboden verbunden
- Hohe Zuverlässigkeit
- Gute spektrale Anpassung an Si-Fotoempfänger
- Hermetisch dichtes Metallgehäuse

Anwendungen

- Lichtschranken für Gleich- und Wechsellichtbetrieb
- IR-Gerätefernsteuerungen
- Sensorik

Features

- Fabricated in a liquid phase epitaxy process
- Anode is electrically connected to the case
- High reliability
- Matches all Si-Photodetectors
- Hermetically sealed package

Applications

- Photointerrupters
- IR remote control
- Sensor technology

Typ Type	Bestellnummer Ordering Code	Strahlstärke ($I_F = 100 \text{ mA}$, $t_p = 20 \text{ ms}$) Radiant Intensity) I_e (mW/sr)
SFH 4881	Q62702P5302	≥ 40 (typ. 72)
SFH 4883	Q62702P5303	≥ 4 (typ. 8)

Grenzwerte ($T_C = 25\text{ °C}$)**Maximum Ratings**

Bezeichnung Parameter	Symbol Symbol	Wert Value	Einheit Unit
Betriebs- und Lagertemperatur Operating and storage temperature range	$T_{op}; T_{stg}$	- 40 ... + 100	°C
Sperrspannung Reverse voltage	V_R	5	V
Durchlaßstrom Forward current	I_F	200	mA
Stoßstrom Surge current $t_p = 10\ \mu\text{s}, D = 0.01$	I_{FSM}	2.5	A
Verlustleistung Power dissipation	P_{tot}	470	mW
Wärmewiderstand Thermal resistance	R_{thJA} R_{thJC}	450 160	K/W K/W

Kennwerte ($T_A = 25\text{ °C}$)**Characteristics**

Bezeichnung Parameter	Symbol Symbol	Wert Value	Einheit Unit
Wellenlänge der Strahlung Wavelength of peak emission	λ_{peak}	880	nm
Spektrale Bandbreite bei 50% von I_{max} Spectral bandwidth at 50% of I_{max}	$\Delta\lambda$	80	nm
Abstrahlwinkel Half angle SFH 4881 SFH 4883	φ φ	± 5 ± 35	Grad deg.
Aktive Chipfläche Active chip area	A	0.16	mm ²
Abmessungen der aktiven Chipfläche Dimension of the active chip area	$L \times B$ $L \times W$	0.4×0.4	mm ²

Kennwerte ($T_A = 25\text{ °C}$) (cont'd)**Characteristics**

Bezeichnung Parameter	Symbol Symbol	Wert Value	Einheit Unit
Schaltzeiten, I_e von 10% auf 90% und von 90% auf 10% Switching times, I_e from 10% to 90% and from 90% to 10% $I_F = 100\text{ mA}$, $R_L = 50\ \Omega$	t_r, t_f	500	ns
Kapazität Capacitance $V_R = 0\text{ V}$, $f = 1\text{ MHz}$	C_o	25	pF
Durchlaßspannung Forward voltage $I_F = 100\text{ mA}$, $t_p = 20\text{ ms}$ $I_F = 1\text{ A}$, $t_p = 100\ \mu\text{s}$ $I_F = 1.5\text{ A}$, $t_p = 100\ \mu\text{s}$	V_F V_F V_F	1.5 (≤ 1.8) 2.4 (≤ 3.0) 2.9 (≤ 3.4)	V V V
Sperrstrom Reverse current $V_R = 5\text{ V}$	I_R	0.01 (≤ 10)	μA
Gesamtstrahlungsfluß Total radiant flux $I_F = 100\text{ mA}$, $t_p = 20\text{ ms}$ SFH 4881 SFH 4883	Φ_e Φ_e	12 15	mW mW

Strahlstärke I_e in Achsrichtunggemessen bei einem Raumwinkel von $\Omega = 0.01\text{ sr}$ **Radiant Intensity I_e in Axial Direction**measured at a solid angle of $\Omega = 0.01\text{ sr}$

Bezeichnung Parameter	Symbol Symbol	Wert Value		Einheit Unit
		SFH 4881	SFH 4883	
Strahlstärke Radiant intensity $I_F = 100\text{ mA}$, $t_p = 20\text{ ms}$	$I_{e\text{ min}}$ $I_{e\text{ typ}}$	40 72	4 8	mW/sr mW/sr
Strahlstärke Radiant intensity $I_F = 1\text{ A}$, $t_p = 100\ \mu\text{s}$	$I_{e\text{ typ}}$	630	70	mW/sr

Relative Spectral Emission

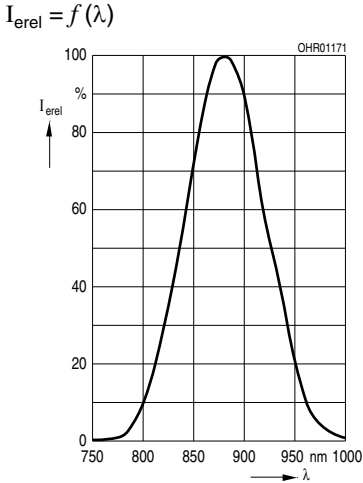

Radiant Intensity

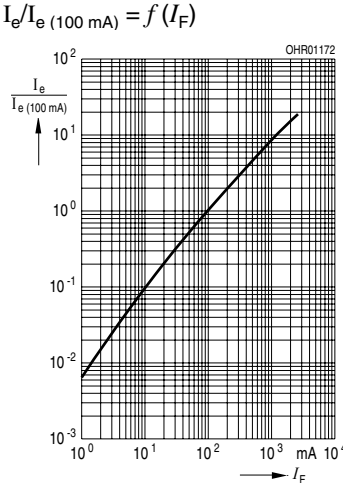

Max. Permissible Forward Current

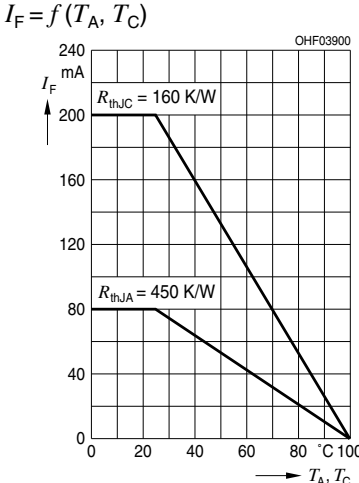

Forward Current

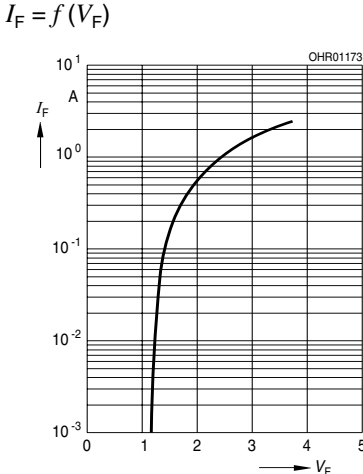

Radiation Characteristics

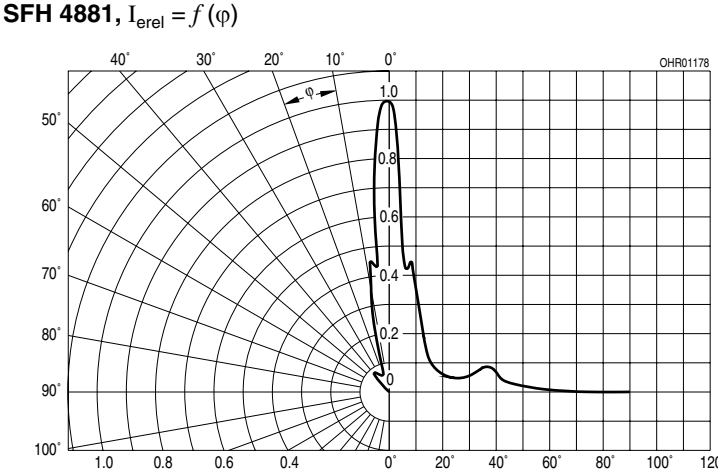

Permissible Pulse Handling Capability
 $I_F = f(\tau), T_C = 25^\circ\text{C}$,
 $R_{\text{thJC}} = 160 \text{ K/W}$, duty cycle $D =$ parameter

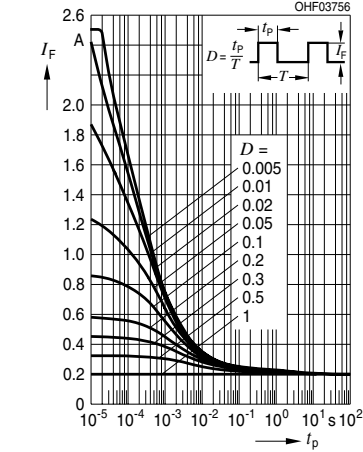

Radiation Characteristics

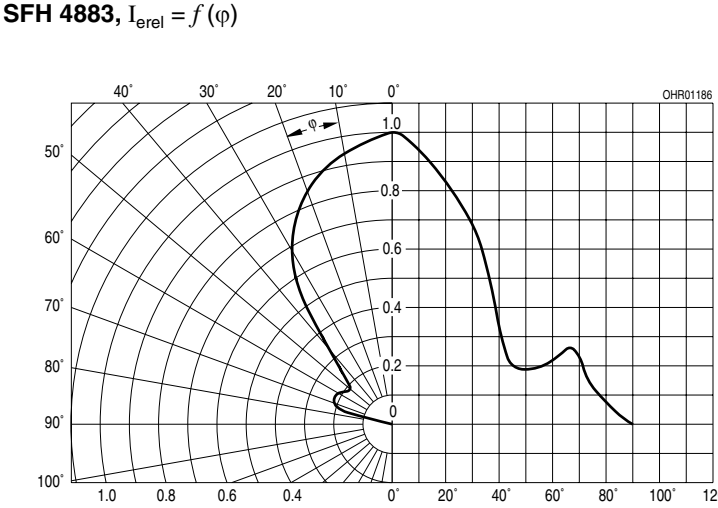

Maßzeichnungen
Package Outlines

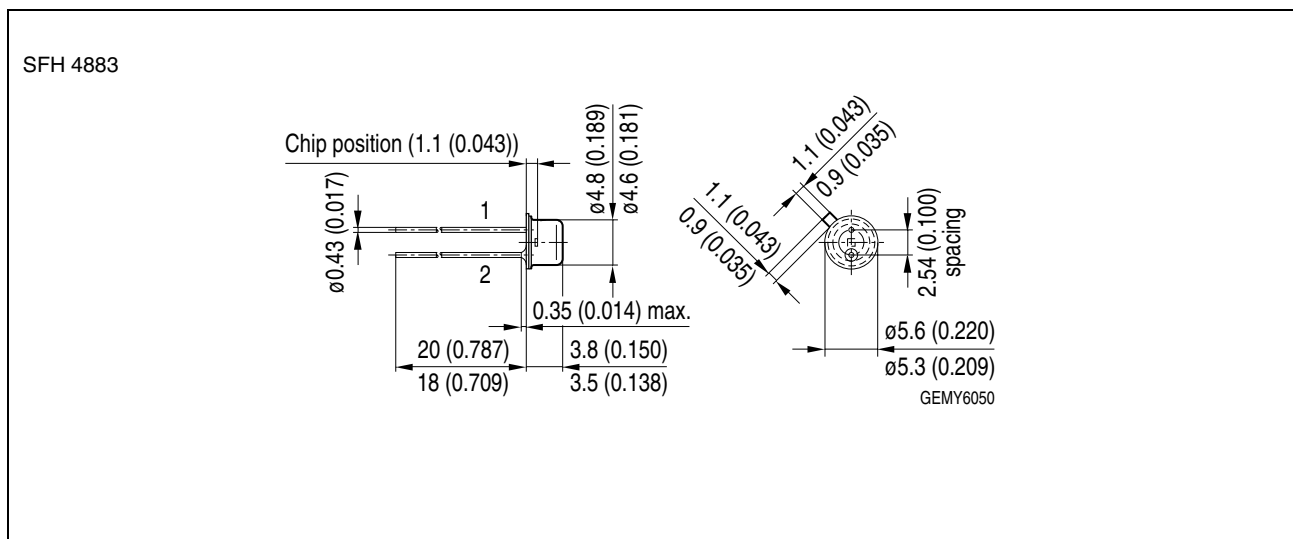
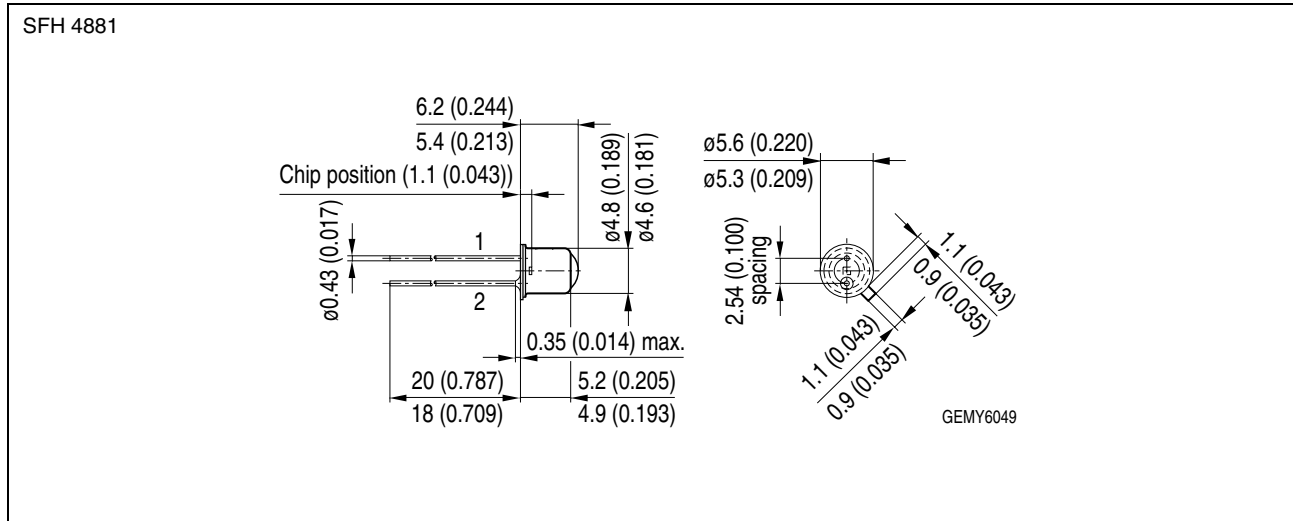

Maße in mm (inch) / Dimensions in mm (inch).

Gehäuse Package	TO-46-Metallgehäuse, Glaslinse, hermetisch dicht, Anschlüsse im 2.54-mm-Raster ($1/10''$) TO-46-metal-package, glass lens, hermetically sealed, solder tabs lead spacing 2.54 mm ($1/10''$)
Anschlussbelegung Pin configuration	Anschluss 2: Kathode Pin 2 : cathode

Lötbedingungen
Soldering Conditions
Wellenlöten (TTW)
TTW Soldering

(nach CECC 00802)
(acc. to CECC 00802)

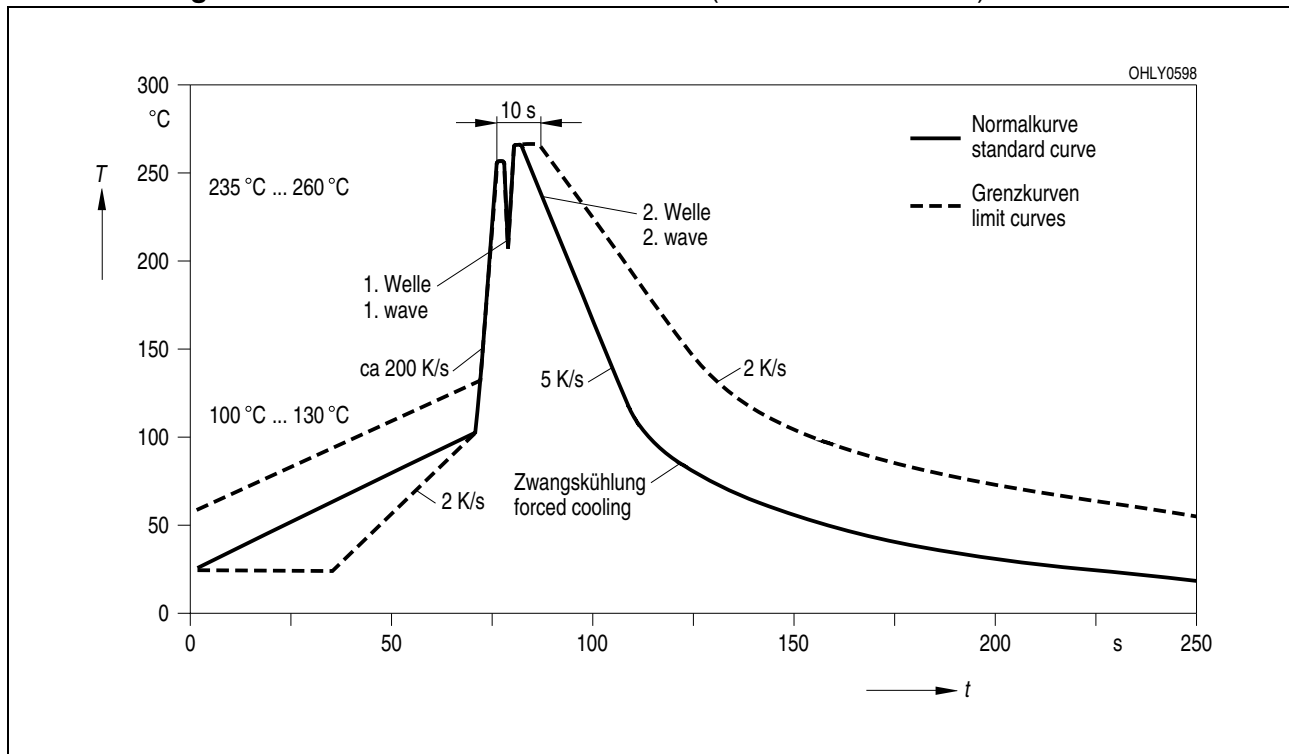

Published by
OSRAM Opto Semiconductors GmbH
Wernerwerkstrasse 2, D-93049 Regensburg
www.osram-os.com

© All Rights Reserved.

The information describes the type of component and shall not be considered as assured characteristics. Terms of delivery and rights to change design reserved. Due to technical requirements components may contain dangerous substances. For information on the types in question please contact our Sales Organization.

Packing

Please use the recycling operators known to you. We can also help you – get in touch with your nearest sales office. By agreement we will take packing material back, if it is sorted. You must bear the costs of transport. For packing material that is returned to us unsorted or which we are not obliged to accept, we shall have to invoice you for any costs incurred.

Components used in life-support devices or systems must be expressly authorized for such purpose! Critical components¹, may only be used in life-support devices or systems² with the express written approval of OSRAM OS.

¹ A critical component is a component used in a life-support device or system whose failure can reasonably be expected to cause the failure of that life-support device or system, or to affect its safety or effectiveness of that device or system.

² Life support devices or systems are intended (a) to be implanted in the human body, or (b) to support and/or maintain and sustain human life. If they fail, it is reasonable to assume that the health of the user may be endangered.

EU RoHS and China RoHS compliant product



此产品符合欧盟 RoHS 指令的要求；

按照中国的相关法规和标准，不含有毒有害物质或元素。