

# ACFM-7101

## PCS/Cellular/GPS Quintplexer

## Datasheet

### Description

The Avago Technologies' ACFM-7101 is a quintplexer that combines PCS and Cellular duplexer functions with a GPS filter, thereby eliminating the need for antenna switching between services.

The ACFM-7101 is designed with Avago Technologies' Film Bulk Acoustic Resonator (FBAR) technology. The ACFM-7101 also utilizes Avago Technologies' innovative Microcap bonded-wafer, chip scale packaging technology. This process allows the filters to be assembled in a module that is less than 1.3 mm high with a footprint of only 5 mm x 8 mm.

Low Tx Insertion Loss reduces power amplifier current, extending battery life and talk time. The ACFM-7101 enhances receiver sensitivity and dynamic range with low Rx Insertion Loss and high rejection of Tx signals at the Rx ports.

The excellent power handling capability of Avago Technologies' FBAR bulk-mode resonators supports the high Tx output power levels needed in handsets while adding virtually no distortion

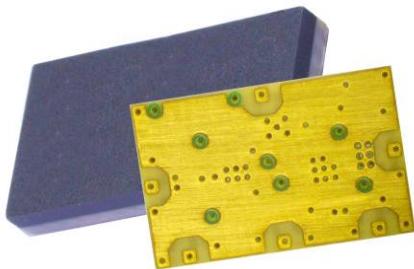

### Functional Block Diagram

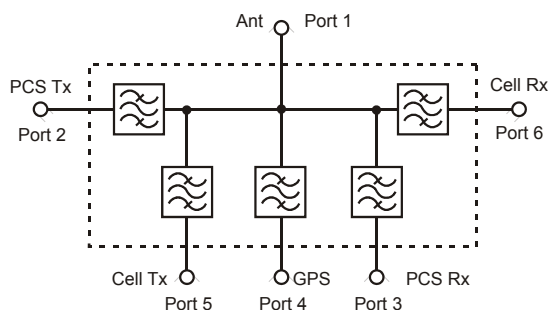

### Features

- Single antenna connection for PCS duplexer, Cellular duplexer, and GPS filter
- Eliminates antenna switching
- Miniature size
  - 5 x 8 mm Footprint
  - 1.3 mm Max Height
- High Power Rating
  - +33 dBm Max Tx Power
- Lead-Free Construction

### Specifications

- Performance guaranteed  $-30$  to  $+85^{\circ}\text{C}$
- GPS Insertion Loss: 1.5 dB Max
- Cellular Duplexer Rx (869 – 894 MHz)
  - Insertion Loss: 3.4 dB Max
  - Noise Blocking: 45 dB Min
- Cellular Duplexer Tx (824 – 849 MHz)
  - Insertion Loss: 2.4 dB Max
  - Interferer Blocking: 55 dB Min
- PCS Duplexer Rx (1930.5 – 1989.5 MHz)
  - Insertion Loss: 4.2 dB Max
  - Noise Blocking: 42 dB Min
- PCS Duplexer Tx (1850.5 – 1909.5 MHz)
  - Insertion Loss: 3.9 dB Max
  - Interferer Blocking: 52 dB Min

### Applications

- Handsets or data terminals operating in the PCS and Cellular frequency bands with GPS capability

ACFM-7101 Electrical Specifications,  $Z_0=50 \Omega$ ,  $T_c$  [1] [2] as indicated

Symbol	Parameter	Units	- 30°C			+25°C			+85°C		
			Min	Typ [3]	Max	Min	Typ [3]	Max	Min	Typ [3]	Max
<b>GPS Filter Performance</b>											
<b>Antenna Port to GPS Receive Port</b>											
S41	Insertion Loss in GPS Band (1574.42–1576.42 MHz)	dB			1.5		1.4	1.5			1.5
S41	Insertion Loss Ripple (p-p) in GPS Band	dB			1.0		0.3	1.0			1.0
S44	Return Loss of GPS Port in GPS Band	dB	9			9	14		9		
S11	Return Loss of Antenna Port in GPS Band	dB	9			9	12		9		
<b>Isolation – Cellular Transmit Port to GPS Port</b>											
S45	Isolation in Cellular Tx Band (824–849 MHz)	dB	30			30	34		30		
S45	Isolation in GPS Band (1574.42–1576.42 MHz)	dB	29			29	33		29		
<b>Isolation – PCS Transmit Port to GPS Port</b>											
S42	Isolation in PCS Tx Band (1850.5 – 1909.5 MHz)	dB	34			34	40		34		
S42	Isolation in GPS Band (1574.42–1576.42 MHz)	dB	34			34	38		34		
<b>Cellular Duplexer Performance</b>											
<b>Antenna Port to Cellular Receive Port</b>											
S61	Insertion Loss in Rx band (869–894 MHz)	dB			3.4		2.5	3.4			3.4
S61	Insertion Loss Ripple (p-p) in Rx Band	dB			1.9		1.0	1.5			1.5
S61	Attenuation in Tx band (824–849 MHz)	dB	55			55	60		55		
S61	Attenuation 0–804 MHz	dB	25			25	31		25		
S61	Attenuation in Tx 2 <sup>nd</sup> harmonic band (1648–1698 MHz)	dB	30			30	40		30		
S61	Attenuation in Tx 3 <sup>rd</sup> harmonic band (2472–2547 MHz)	dB	19			20	27		20		
S66	Return Loss of Rx Port in Rx Band (869–894 MHz)	dB	9			9	12		9		
S11	Return Loss of Antenna Port in Rx Band (869–894 MHz)	dB	9			9	12		9		

ACFM-7101 Electrical Specifications,  $Z_0=50 \Omega$ ,  $T_c$  [1] [2] as indicated (cont)

Symbol	Parameter	Units	- 30°C			+25°C			+85°C		
			Min	Typ [3]	Max	Min	Typ [3]	Max	Min	Typ [3]	Max
<b>Cellular Transmit Port to Antenna Port</b>											
S51	Insertion Loss in Tx band (824–849 MHz)	dB			2.4		2.0	2.4			2.4
S21	Insertion Loss Ripple (p-p) in Tx Band	dB			1.7		1.0	1.4			1.6
S51	Attenuation in Rx band (869–894 MHz)	dB	45			45	48		45		
S51	Attenuation 0–804 MHz	dB	20			20	26		20		
S51	Attenuation in Tx 2 <sup>nd</sup> harmonic band (1648–1698 MHz)	dB	20			20	33		20		
S51	Attenuation in Tx 3 <sup>rd</sup> harmonic band (2472–2547 MHz)	dB	8			9	13		9		
S55	Return Loss of Tx Port in Tx band (824–849 MHz)	dB	9			9	12		9		
S11	Return Loss of Antenna port in Tx Band (824–849 MHz)	dB	9			9	12		9		
<b>Isolation, Cellular Transmit Port to Cellular Receive Port</b>											
S65	Isolation, Tx to Rx port in Receive Band (869–894 MHz)	dB	46			46	50		46		
S65	Isolation, Tx to Rx port in Transmit Band (824–849 MHz)	dB	55			55	60		55		
<b>PCS Duplexer Performance</b>											
<b>Antenna Port to PCS Receive Port</b>											
S31	Insertion Loss in Rx Band (1930.5–1989.5 MHz)	dB			4.2		3.2	4.2			4.2
S31	Insertion Loss Ripple (p-p) in Rx Band	dB			3.0		1.4	2.6			2.6
S31	Attenuation in Tx Band (1850.5–1909.5 MHz)	dB	52			52	55		52		
S31	Attenuation 0.03–1770 MHz	dB	19.5			20	41		20		
S31	Attenuation 2020–3700 MHz	dB	30			30	47		30		
S31	Attenuation 3820–4000 MHz	dB	30			30	35		30		
S33	Return Loss of Rx Port in Rx Band (1930.5–1989.5 MHz)	dB	9			9	12		9		
S11	Return Loss of Antenna Port in Rx Band (1930.5–1989.5 MHz)	dB	9			9	12		9		

ACFM-7101 Electrical Specifications,  $Z_0=50 \Omega$ ,  $T_c$  [1] [2] as indicated (cont)

Symbol	Parameter	Units	- 30°C			+25°C			+85°C		
			Min	Typ [3]	Max	Min	Typ [3]	Max	Min	Typ [3]	Max
<b>PCS Transmit Port to Antenna Port</b>											
S21	Insertion Loss in Tx Band (1850.5–1909.5 MHz)	dB			3.9	3.0	3.9			3.9	
S21	Insertion Loss Ripple (p-p) in Tx Band	dB			2.3	1.4	2.3			3.0	
S21	Attenuation in Rx Band (1930.5–1989.5 MHz)	dB	42			42	45		42		
S21	Attenuation 0.03–1570 MHz	dB	20			20	45		20		
S21	Attenuation in GPS Band (1574.42–1576.42 MHz)	dB	30			30	36		30		
S21	Attenuation 1580 – 1700 MHz	dB	25			25	36		25		
S21	Attenuation in Tx 2 <sup>nd</sup> harmonic band (3701–3819 MHz)	dB	20			20	30		20		
S22	Return Loss of Tx Port in Tx band (1850.5–1909.5 MHz)	dB	9.5			9.5	12		9.5		
S11	Return Loss of Antenna port in Tx Band (1850.5–1909.5 MHz)	dB	9			9	12		9		
<b>Isolation, PCS Transmit Port to PCS Receive Port</b>											
S32	Isolation, Tx to Rx port in Receive Band (1930.5–1989.5 MHz)	dB	45			45	50		45		
S32	Isolation, Tx to Rx port in Transmit Band (1850.5–1909.5 MHz)	dB	54			54	60		54		

**Notes:**

1.  $T_c$  is the case temperature and is defined as the temperature of the underside of the quintplexer where it makes contact with the circuit board.
2. Specifications are guaranteed at the indicated temperature with the input power to the Tx ports equal to or less than +29 dBm over all Tx frequencies unless otherwise noted.
3. Typical data is the average value of the parameter over the indicated band at the specified temperature. Refer to “Characterization” section for measurement details.

## Absolute Maximum Ratings <sup>[1]</sup>

Parameter	Unit	Value
Storage temperature	°C	-65 to +125
Maximum RF Input Power to Tx Ports	dBm	+33

## Maximum Recommended Operating Conditions <sup>[2]</sup>

Parameter	Unit	Value
Operating temperature, T <sub>c</sub> <sup>[3]</sup> , Tx Power 29 dBm	°C	-40 to +100
Operating temperature, T <sub>c</sub> <sup>[3]</sup> , Tx Power 30 dBm	°C	-40 to +85

### Notes:

1. Operation in excess of any one of these conditions may result in permanent damage to the device.
2. The device will function over the recommended range without degradation in reliability or permanent change in performance, but is not guaranteed to meet electrical specifications.
3. T<sub>c</sub> is defined as case temperature, the temperature of the underside of the quintplexer where it makes contact with the circuit board.

## Characterization

A test circuit similar to that shown in Figure 1 was used to measure typical device performance. This circuit is designed to interface with Air Coplanar (ACP), Ground-Signal-Ground (GSG) RF probes of the type commonly used to test semiconductor wafers.

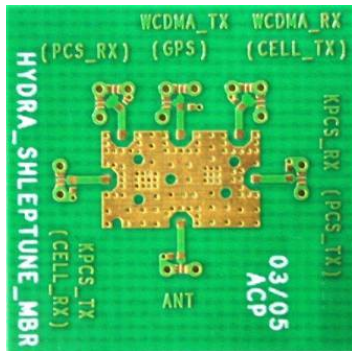

Figure 1. ACP Probe Test Circuit.

The test circuit is a 17.7 x 17.7 mm PCB with a well-grounded pad to which the device under test (DUT) is solder-mounted.

Short lengths of 50-ohm microstripline connect the DUT to ACP probe patterns on the board.

A test circuit with a ACFM-7101 mounted in place is shown in Figure 2. S-parameters are then measured using a network analyzer and calibrated ACP probe set.

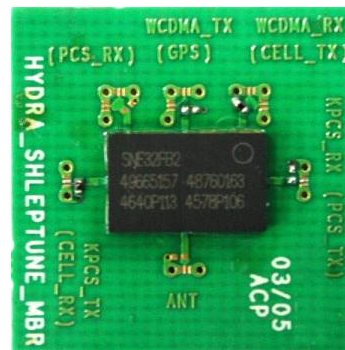
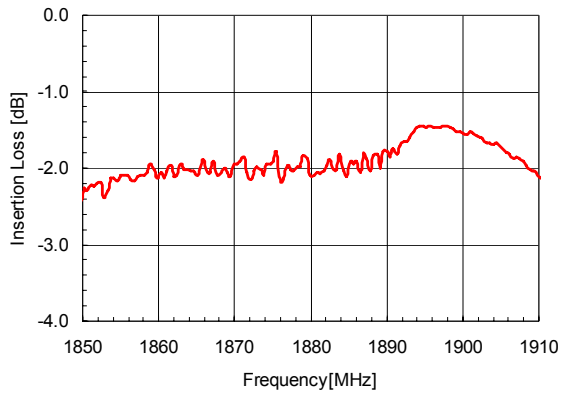

Figure 2. Test Circuit with ACFM-7101 Quintplexer.

Phase data for s-parameters measured with ACP probe circuits are adjusted to place the reference plane at the edge of the quintplexer.

**ACFM-7101 Typical Performance at  $T_c = 25^\circ\text{C}$**



**Figure 3. PCS Tx Band Insertion Loss.**

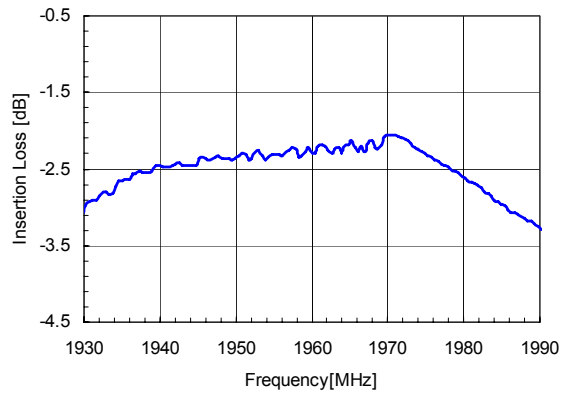

**Figure 4. PCS Rx Band Insertion Loss.**

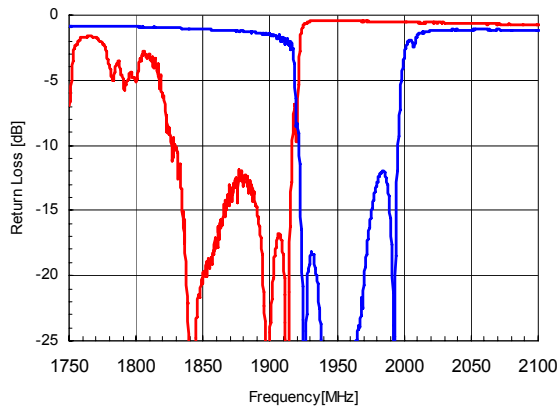

**Figure 5. PCS Tx and Rx Port Return Loss.**

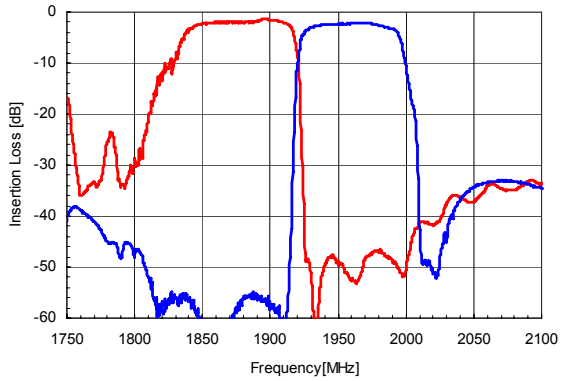

**Figure 6. PCS Tx Rejection in Rx Band and Rx Rejection in Tx Band.**

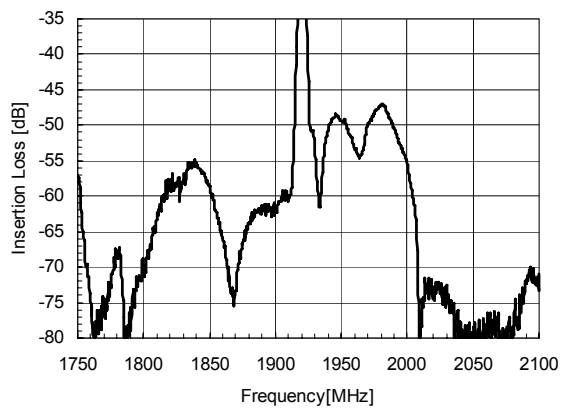

**Figure 7. PCS Tx-Rx Isolation.**

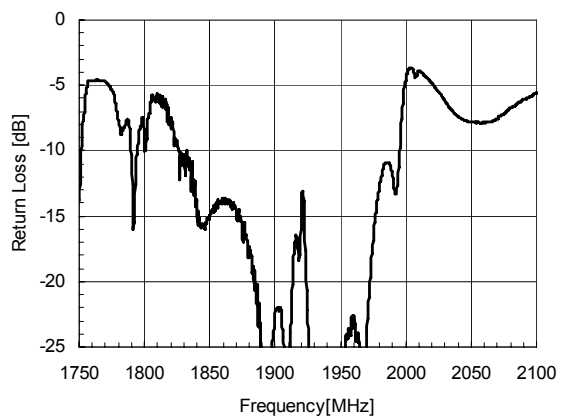

**Figure 8. PCS Antenna Port Return Loss.**

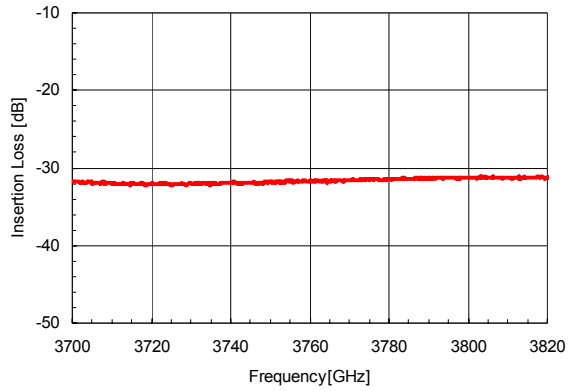

**Figure 9. PCS Tx-Ant Rejection at Tx Second Harmonic.**

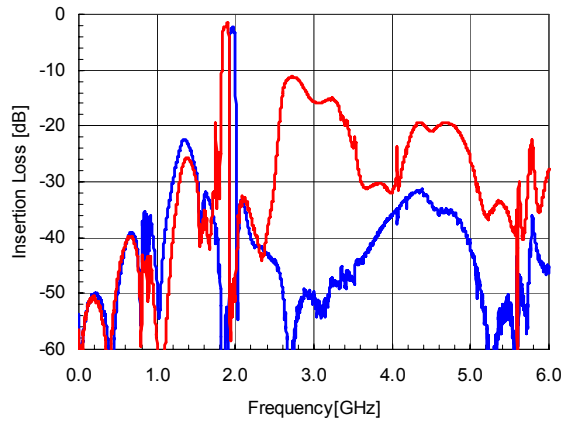

**Figure 10. PCS Tx-Ant and Rx-Ant Wideband Insertion Loss.**

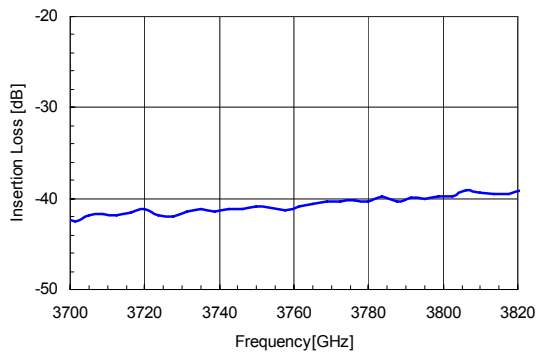

**Figure 11. PCS Ant-Rx Rejection at Tx Second Harmonic.**

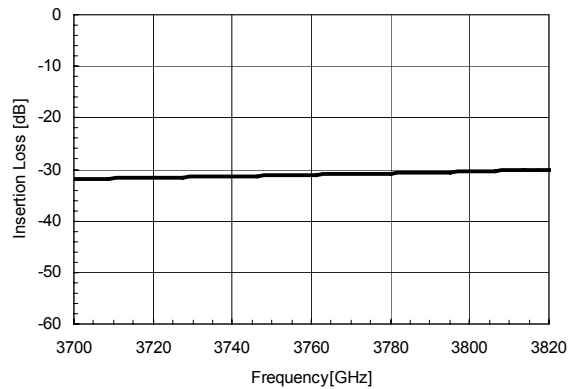

**Figure 12. PCS Tx-Rx Isolation in Tx Second Harmonic Band.**

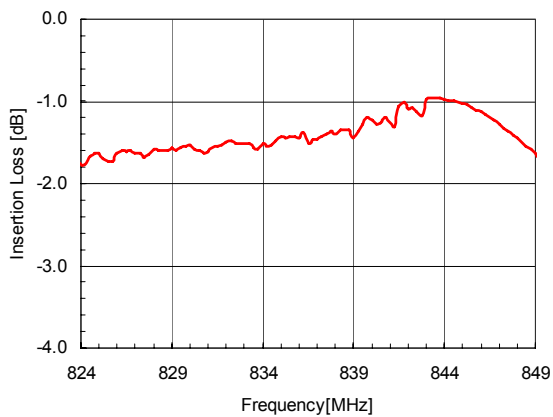

**Figure 13. Cellular Tx Insertion Loss.**

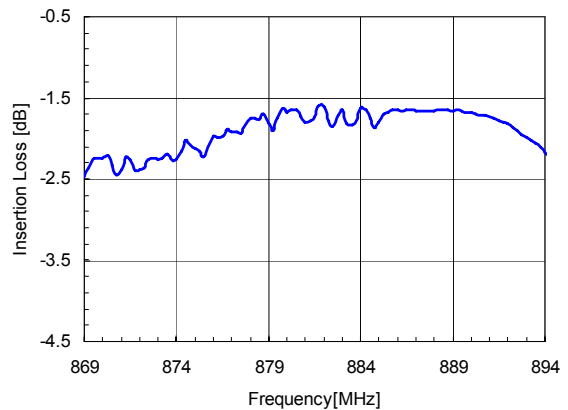

**Figure 14. Cellular Rx Insertion Loss.**

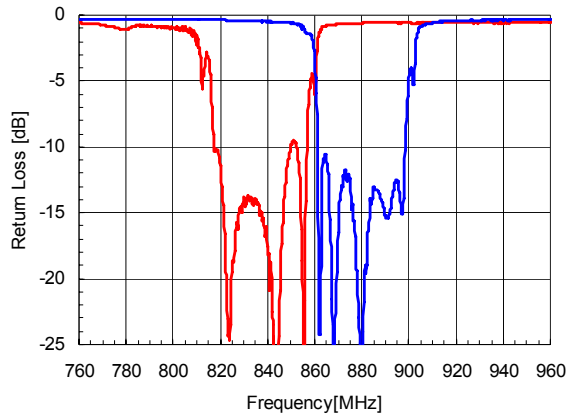

Figure 15. Cellular Tx and Rx Return Loss.

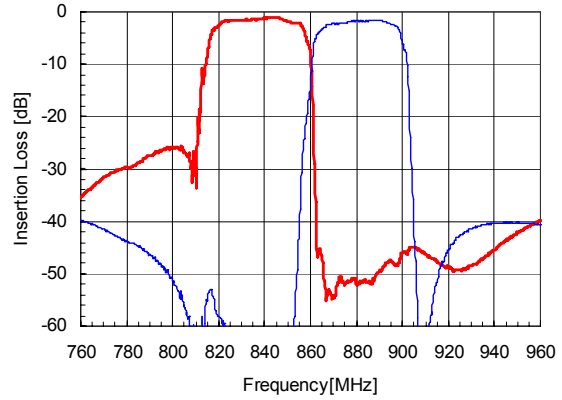

Figure 16. Cellular Tx Rejection in Rx Band and Rx Rejection in Tx Band.

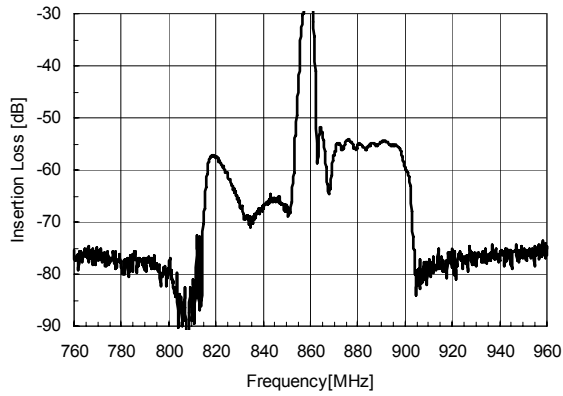

Figure 17. Cellular Tx-Rx Isolation.

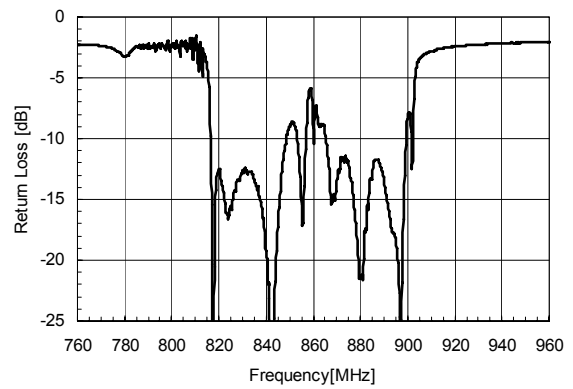

Figure 18. Cellular Band Antenna Return Loss.

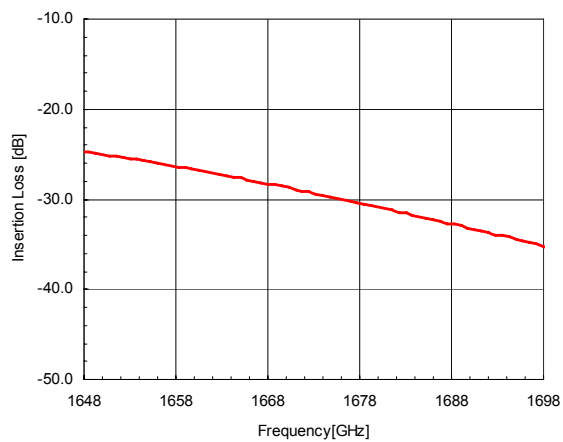

Figure 19. Cellular Tx-Ant Rejection at Tx Second Harmonic.

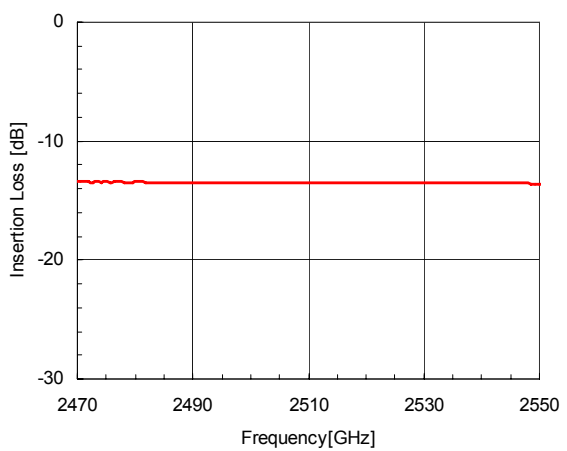
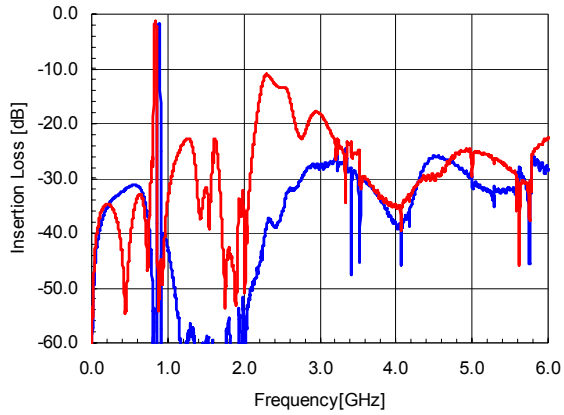
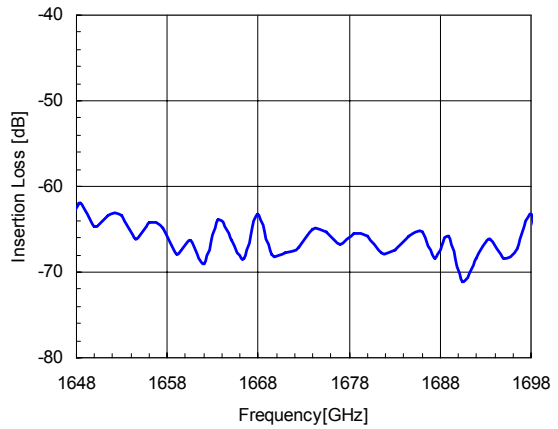

Figure 20. Cellular Tx-Ant Rejection at Tx Third Harmonic.

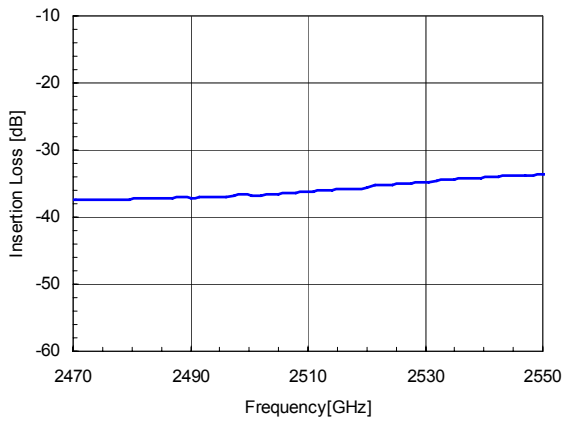



**Figure 21. Cellular Tx-Ant and Ant-Rx Wideband Insertion Loss.**



**Figure 22. Cellular Ant-Rx Rejection at Tx Second Harmonic.**



**Figure 23. Cellular Ant-Rx Rejection at Tx Third Harmonic.**

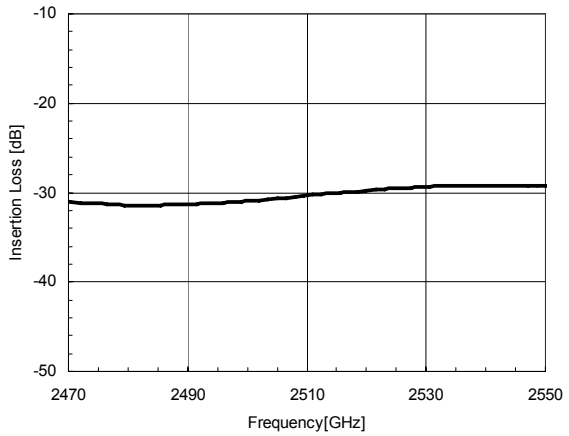

**Figure 24. Cellular Tx-Rx Isolation at Tx Second Harmonic.**

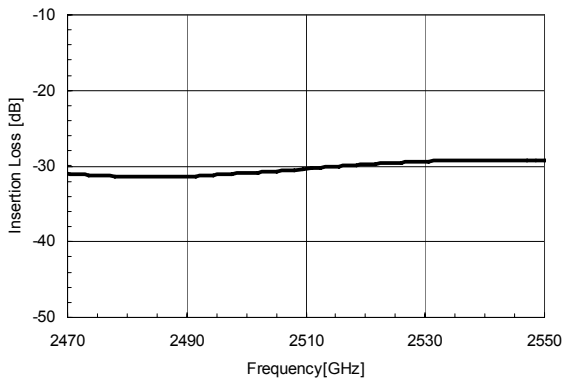

**Figure 25. Cellular Tx-Rx Isolation at Tx Third Harmonic.**

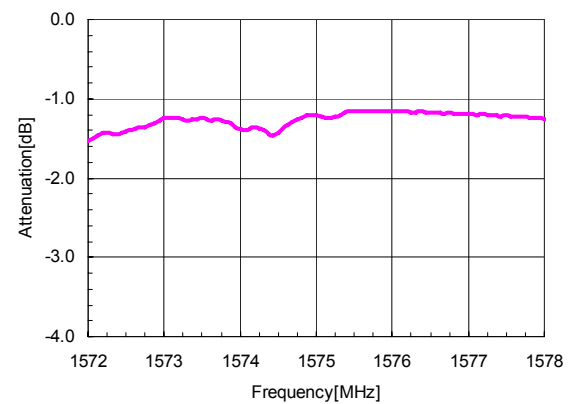

**Figure 26. Ant-GPS Insertion Loss.**

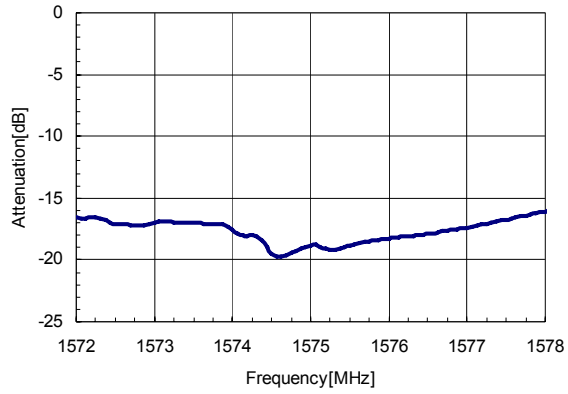

Figure 27. GPS Port Return Loss.

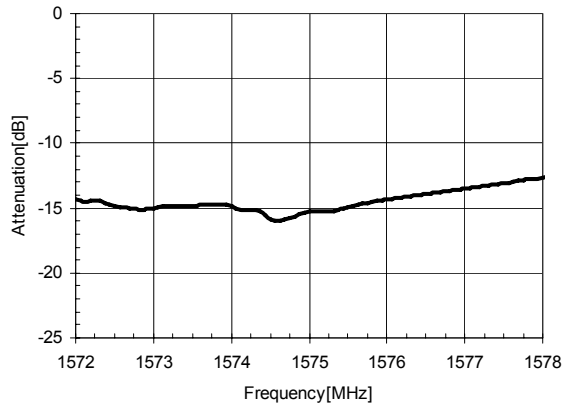

Figure 28. Antenna Port Return Loss in GPS Band.

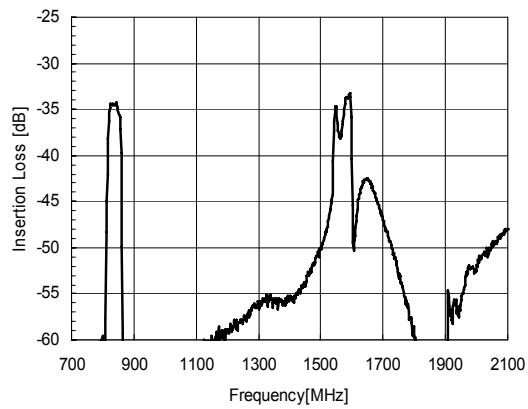

Figure 29. Cellular Tx Port to GPS Port Isolation.

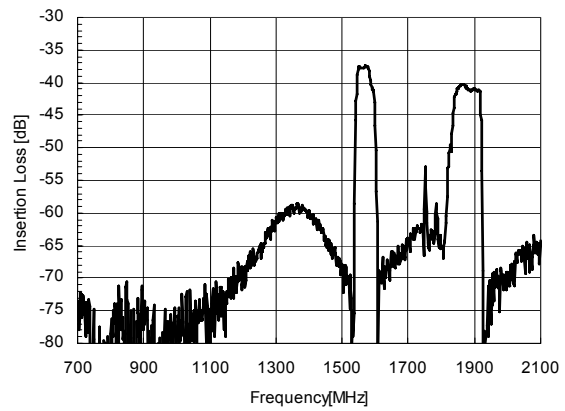
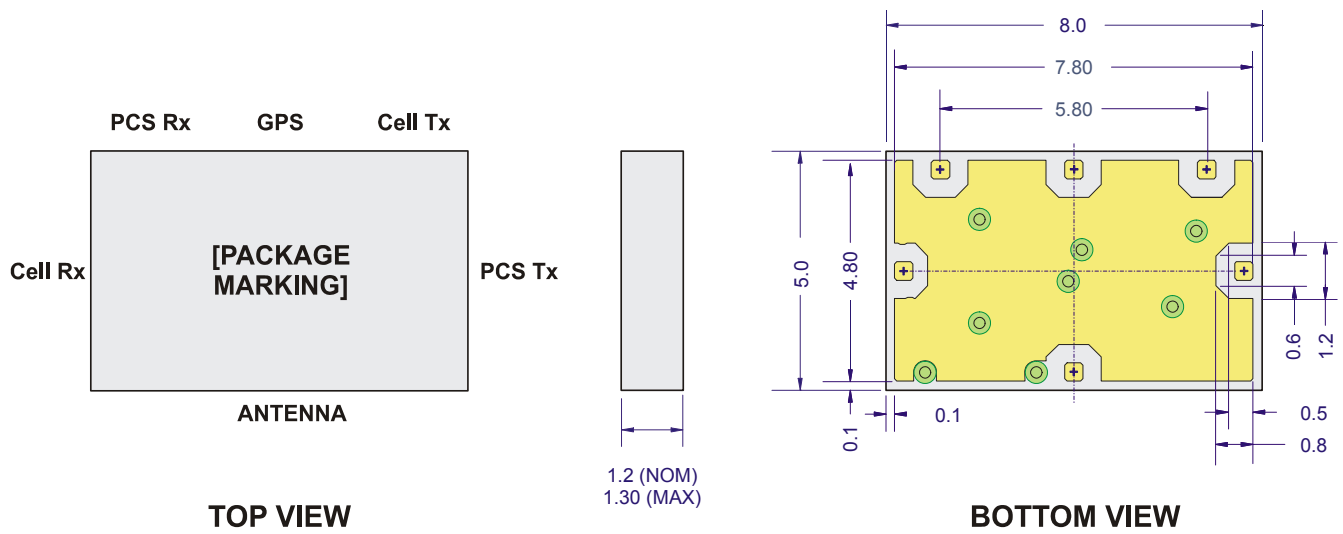

Figure 30. PCS Tx Port to GPS Port Isolation.



Notes:

1. Dimensions in millimeters
2. Tolerance: X.X ±0.1, X.XX ±0.05
3. I/O pads (6 ea): 0.37 x 0.37, corner chamfer 0.05 x 0.05
4. Contact areas are gold plated



Figure 31. Package Outline Drawing.

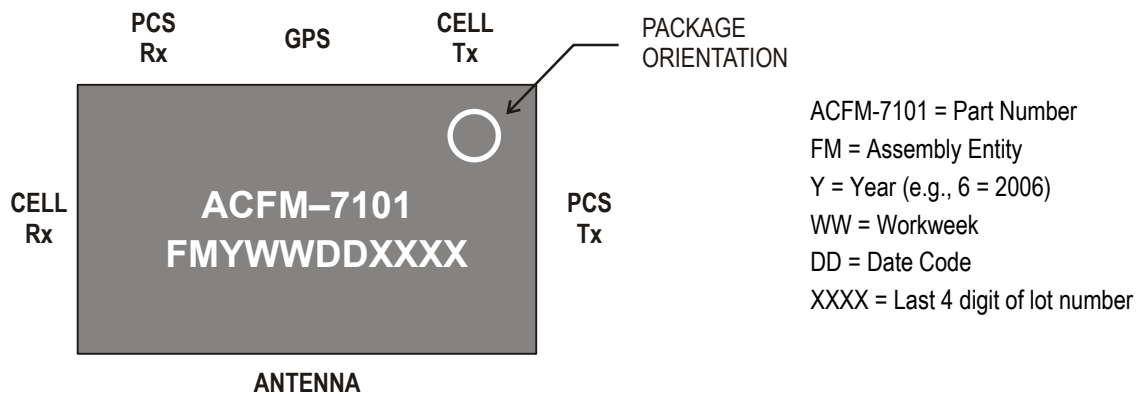
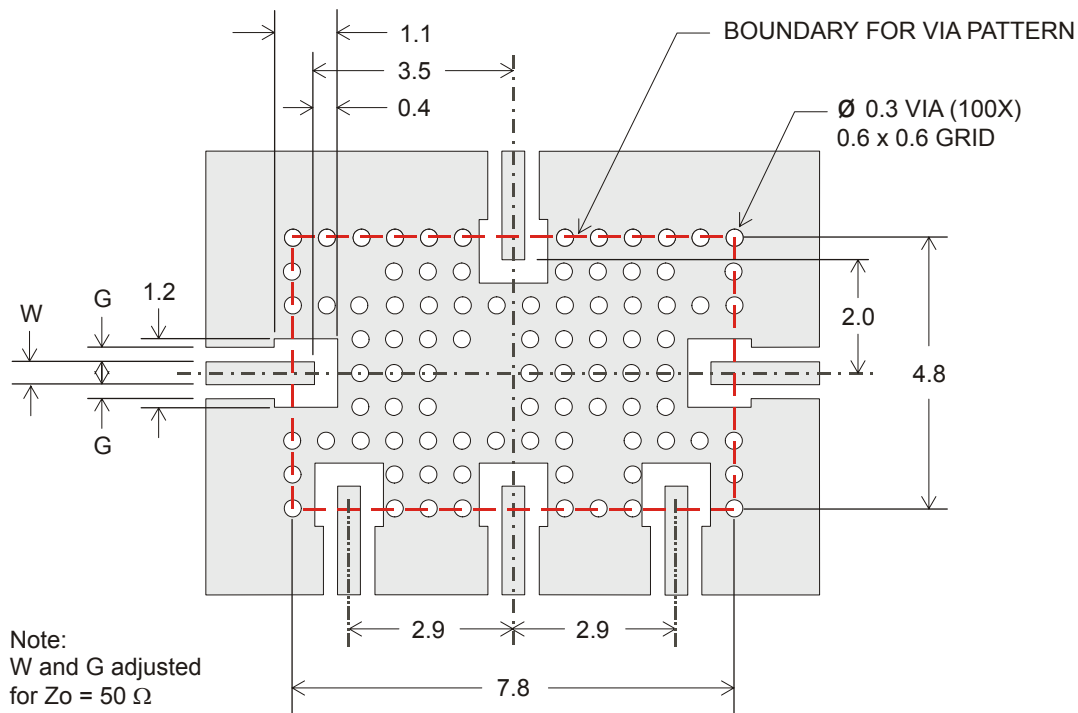
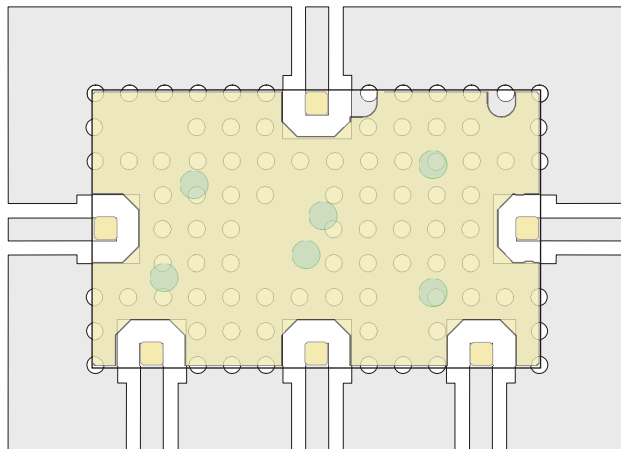

Figure 32. Package Marking.



**Figure 33. Recommended PCB Land Print.**



**Figure 34. ACFM-7101 Outline and Bottom Metal Superposed on PCB Land Print.**

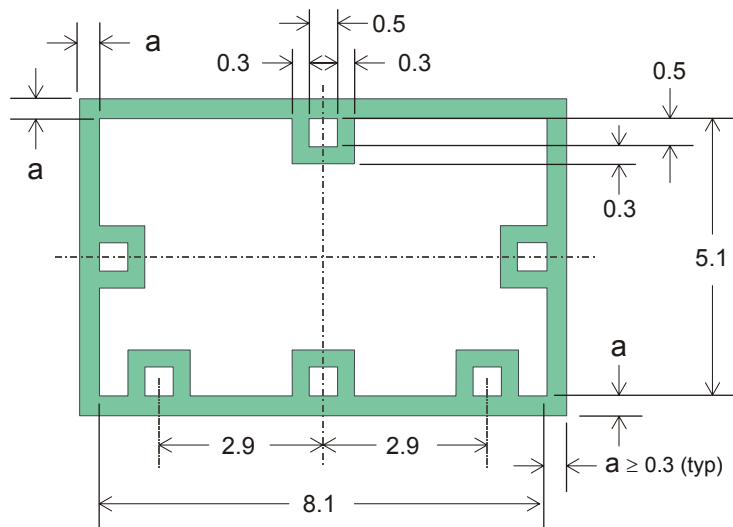
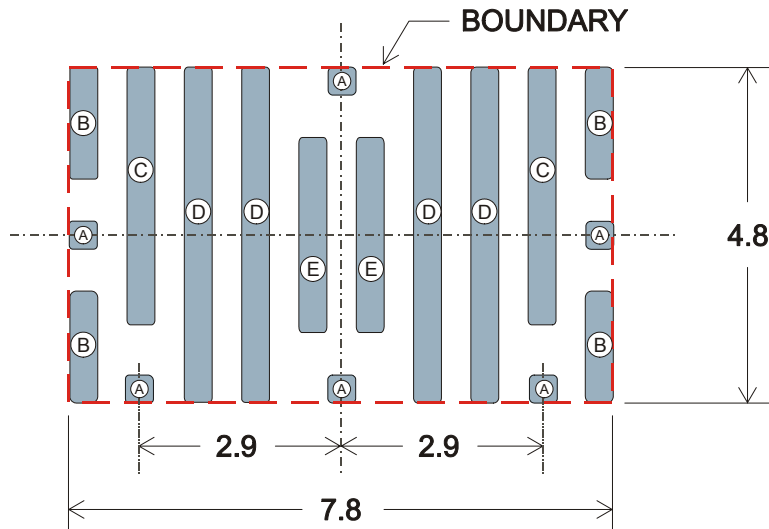

Figure 35. Recommended Solder Mask.



Dimensions of Solder Stencil Openings

Stencil Opening ID	Qty	Width (mm)	Length (mm)
A	6	0.4	0.4
B	4	0.4	1.6
C	2	0.4	3.7
D	4	0.4	4.8
E	2	0.4	2.8

Notes:

1. Radius all corners 0.05 mm
2. Stencil openings aligned to the Boundary rectangle
3. Stencil openings equally spaced horizontally (spacing = 0.422 mm)
4. Area Ratio = 54%

Figure 32. Recommended Solder Stencil.

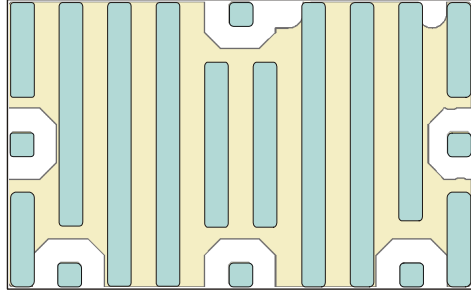

**Figure 33. Solder Stencil Overlaid on ACFM-7101 Bottom Metal Pattern.**

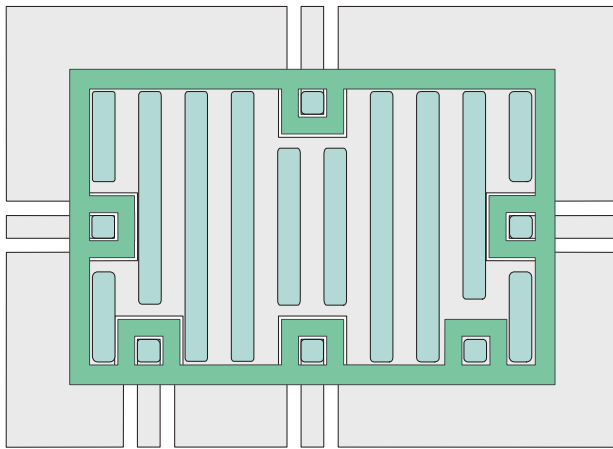

**Figure 34. Solder Stencil and Solder Mask Overlaid on Land Print.**

## Package Moisture Sensitivity

Feature	Test Method	Performance
Moisture Sensitivity Level (MSL) at 260°C	J-STD-020C	Level 3

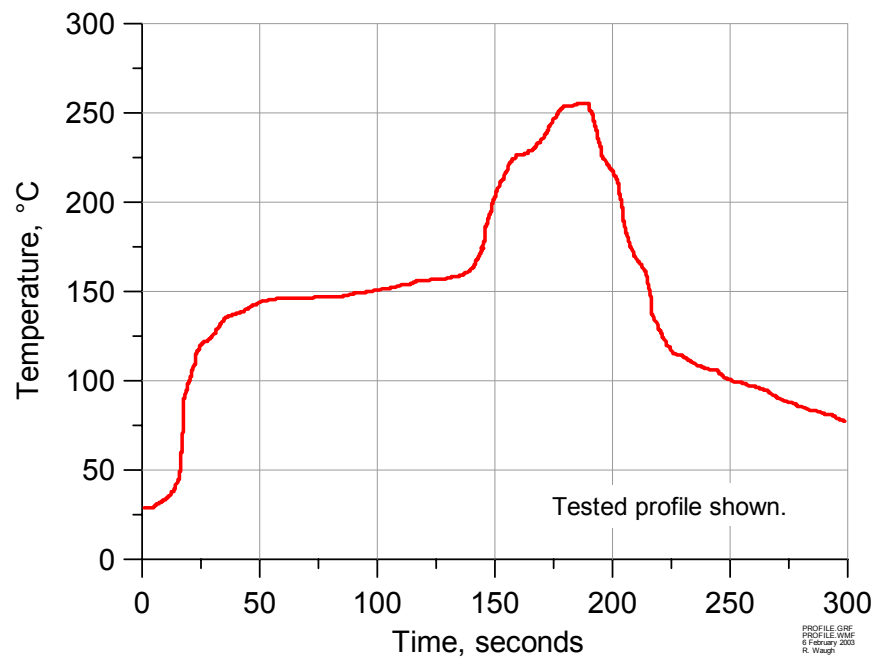

Figure 35. Verified SMT Solder Profile.

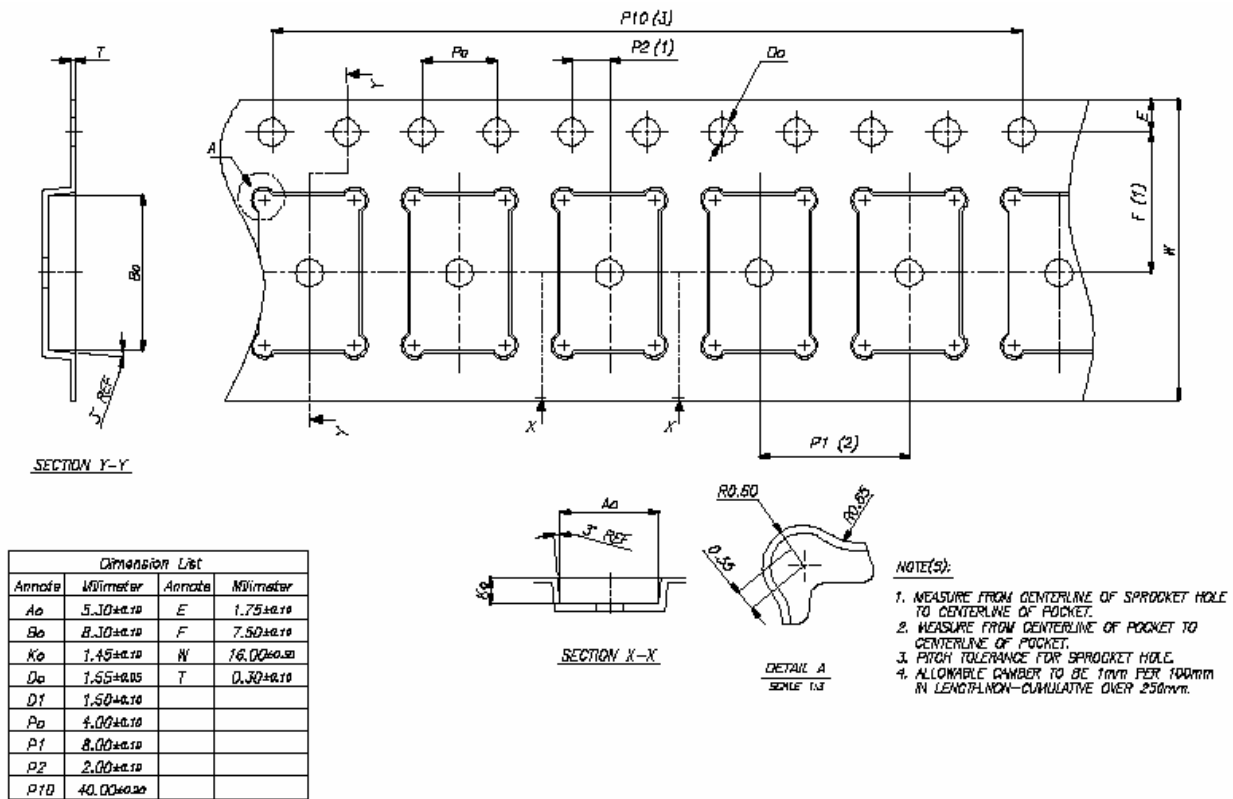

Figure 36. SMT Tape Packing.

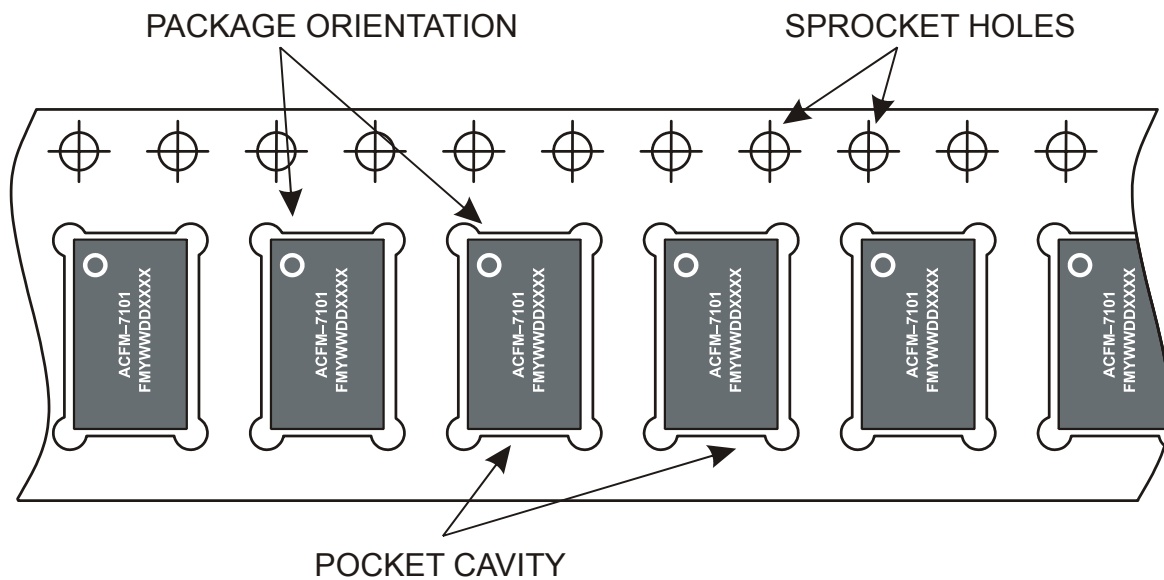

Figure 37. Orientation in Tape.



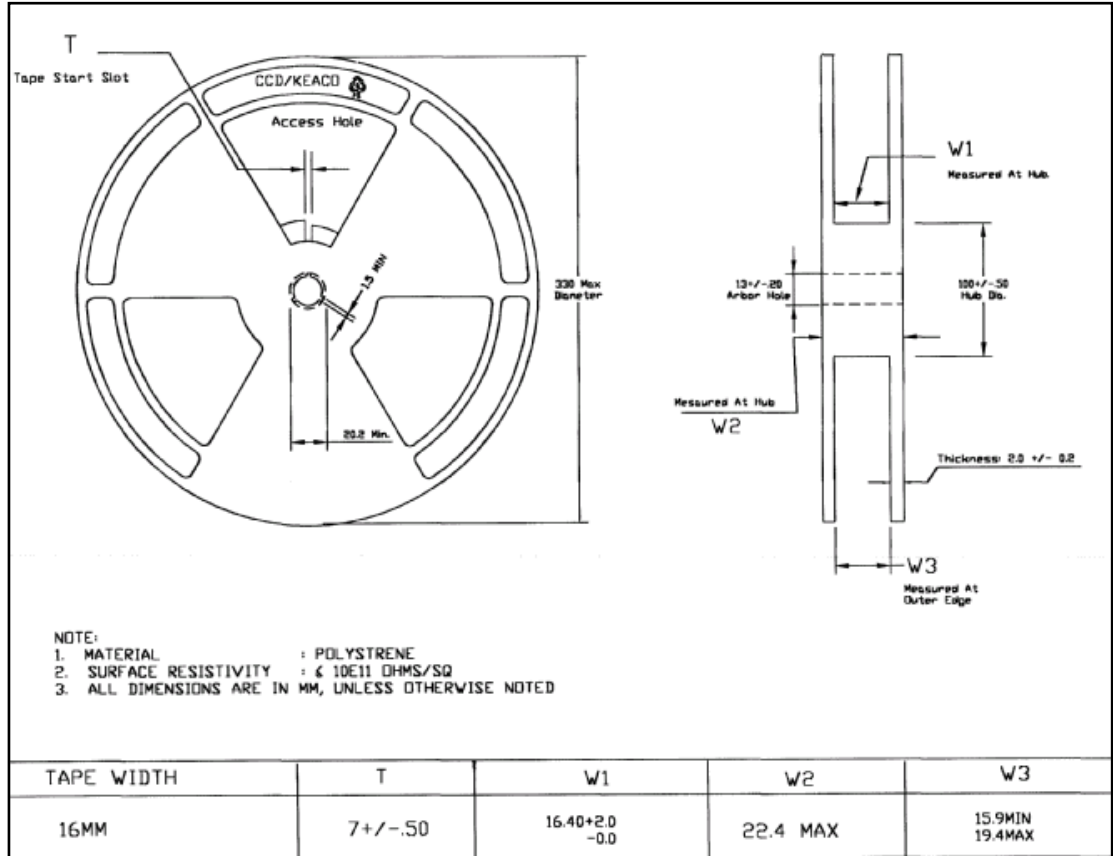

Figure 38. Reel Information.

### ACFM-7101 Ordering Information

Part Number	No. of Devices	Container
ACFM-7101-BLKG	100	Anti-static Bag
ACFM-7101-TR1G	3000	14-inch Reel

For product information and a complete list of distributors, please go to our web site: [www.avagotech.com](http://www.avagotech.com)

Avago, Avago Technologies, and the A logo are trademarks of Avago Technologies, Pte. in the United States and other countries. Data subject to change. Copyright © 2006 Avago Technologies Pte. All rights reserved.  
RLM Ver 3.8

