

NTP75N03-06, NTB75N03-06

Power MOSFET 75 Amps, 30 Volts N-Channel TO-220 and D²PAK

This 20 V_{GS} gate drive vertical Power MOSFET is a general purpose part that provides the “best of design” available today in a low cost power package. This power MOSFET is designed to withstand high energy in the avalanche and commutation modes. The Drain-to-Source Diode has a fast response with soft recovery.

Features

- Ultra-Low R_{DS(on)}, Single Base, Advanced Technology
- SPICE Parameters Available
- Diode is Characterized for Use in Bridge Circuits
- I_{DSS} and V_{DS(on)} Specified at Elevated Temperatures
- High Avalanche Energy Capability
- ESD JEDAC Rated HBM Class 1, MM Class B, CDM Class 0

Typical Applications

- Power Supplies
- Inductive Loads
- PWM Motor Controls
- Replaces MTP1306 and MTB1306

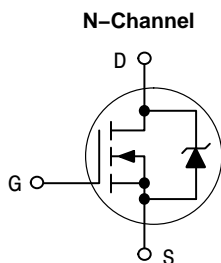

ON Semiconductor®

<http://onsemi.com>

V _{(BR)DSS}	R _{DS(on)} TYP	I _D MAX
30 A	5.3 mΩ @ 10 V	75 A

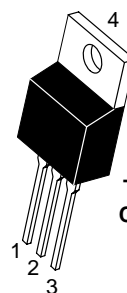

TO-220AB
CASE 221A
Style 5

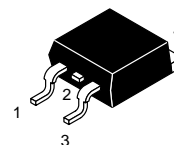

D²PAK
CASE 418AA
Style 2

MARKING DIAGRAMS & PIN ASSIGNMENTS

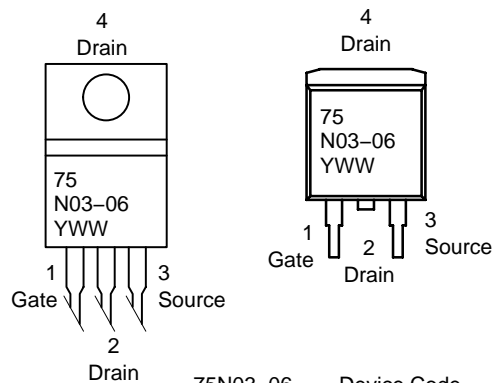

75N03-06 = Device Code
Y = Year
WW = Work Week

ORDERING INFORMATION

Device	Package	Shipping†
NTP75N03-06	TO-220	50 Units/Rail
NTB75N03-06	D ² PAK	50 Units/Rail
NTB75N03-06T4	D ² PAK	800/Tape & Reel

†For information on tape and reel specifications, including part orientation and tape sizes, please refer to our Tape and Reel Packaging Specifications Brochure, BRD8011/D.

NTP75N03-06, NTB75N03-06

MAXIMUM RATINGS ($T_J = 25^\circ\text{C}$ unless otherwise noted)

Rating	Symbol	Value	Unit
Drain-to-Source Voltage	V_{DSS}	30	Vdc
Drain-to-Gate Voltage (RGS = 10 M Ω)	V_{DGB}	30	Vdc
Gate-to-Source Voltage – Continuous	V_{GS}	± 20	Vdc
Non-repetitive ($t_p \leq 10$ ms)	V_{GS}	± 24	Vdc
Drain Current – Continuous @ $T_C = 25^\circ\text{C}$ – Continuous @ $T_C = 100^\circ\text{C}$ – Single Pulse ($t_p \leq 10$ μs)	I_D I_D I_{DM}	75 59 225	Adc Adc Apk
Total Power Dissipation @ $T_C = 25^\circ\text{C}$ Derate above 25°C Total Power Dissipation @ $T_A = 25^\circ\text{C}$ (Note 1)	P_D	125 1.0 2.5	W W/ $^\circ\text{C}$ W
Operating and Storage Temperature Range	T_J and T_{stg}	-55 to 150	$^\circ\text{C}$
Single Pulse Drain-to-Source Avalanche Energy – Starting $T_J = 25^\circ\text{C}$ ($V_{DD} = 38$ Vdc, $V_{GS} = 10$ Vdc, $L = 1$ mH, $I_L(\text{pk}) = 55$ A, $V_{DS} = 40$ Vdc)	E_{AS}	1500	mJ
Thermal Resistance – Junction-to-Case – Junction-to-Ambient – Junction-to-Ambient (Note 1)	$R_{\theta JC}$ $R_{\theta JA}$ $R_{\theta JA}$	1.0 62.5 50	$^\circ\text{C/W}$
Maximum Lead Temperature for Soldering Purposes, 1/8" from case for 10 seconds	T_L	260	$^\circ\text{C}$

1. When surface mounted to an FR4 board using the minimum recommended pad size.

NTP75N03-06, NTB75N03-06

ELECTRICAL CHARACTERISTICS (T_A = 25°C unless otherwise noted)

Characteristic	Symbol	Min	Typ.	Max	Unit
----------------	--------	-----	------	-----	------

OFF CHARACTERISTICS

Drain-Source Breakdown Voltage (Note 2) (V _{GS} = 0 Vdc, I _D = 250 μAdc) Temperature Coefficient (Negative)	V _{(BR)DSS}	30	– –57	– –	Vdc mV°C
Zero Gate Voltage Drain Current (V _{DS} = 30 Vdc, V _{GS} = 0 Vdc) (V _{DS} = 30 Vdc, V _{GS} = 0 Vdc, T _J = 150°C)	I _{DSS}	– –	– –	1.0 10	μAdc
Gate-Body Leakage Current (V _{GS} = ±20 Vdc, V _{DS} = 0 Vdc)	I _{GSS}	–	–	±100	nAdc

ON CHARACTERISTICS (Note 2)

Gate Threshold Voltage (Note 2) (V _{DS} = V _{GS} , I _D = 250 μAdc) Threshold Temperature Coefficient (Negative)	V _{GS(th)}	1.0 –	1.6 –6	2.0 –	Vdc mV°C
Static Drain-to-Source On-Resistance (Note 2) (V _{GS} = 10 Vdc, I _D = 37.5 Adc)	R _{DS(on)}	–	5.3	6.5	mΩ
Static Drain-to-Source On Resistance (Note 2) (V _{GS} = 10 Vdc, I _D = 75 Adc) (V _{GS} = 10 Vdc, I _D = 37.5 Adc, T _J = 125°C)	V _{DS(on)}	– –	0.53 0.35	0.68 0.50	Vdc
Forward Transconductance (Notes 2 & 4) (V _{DS} = 3 Vdc, I _D = 20 Adc)	g _{FS}	–	58	–	Mhos

DYNAMIC CHARACTERISTICS (Note 4)

Input Capacitance	(V _{DS} = 25 Vdc, V _{GS} = 0, f = 1.0 MHz)	C _{iss}	–	4398	5635	pF
Output Capacitance		C _{oss}	–	1160	1894	
Transfer Capacitance		C _{rss}	–	317	430	

SWITCHING CHARACTERISTICS (Notes 3 and 4)

Turn-On Delay Time	(V _{GS} = 5.0 Vdc, V _{DD} = 20 Vdc, I _D = 75 Adc, R _G = 4.7 Ω) (Note 2)	t _{d(on)}	–	16	30	ns
Rise Time		t _r	–	130	200	
Turn-Off Delay Time		t _{d(off)}	–	65	110	
Fall Time		t _f	–	105	175	
Gate Charge	(V _{GS} = 5.0 Vdc, I _D = 75 Adc, V _{DS} = 24 Vdc) (Note 2)	Q _T	–	57	75	nC
		Q ₁	–	11	15	
		Q ₂	–	34	50	

SOURCE-DRAIN DIODE CHARACTERISTICS

Forward On-Voltage	(I _S = 75 Adc, V _{GS} = 0 Vdc) (I _S = 75 Adc, V _{GS} = 0 Vdc, T _J = 125°C) (Note 2)	V _{SD}	– –	1.19 1.09	1.25 –	Vdc
Reverse Recovery Time (Note 4)	(I _S = 75 Adc, V _{GS} = 0 Vdc di _S /dt = 100 A/μs) (Note 2)	t _{rr}	–	37	–	ns
		t _a	–	20	–	
Reverse Recovery Stored Charge (Note 4)		t _b	–	17	–	μC
		Q _{RR}	–	0.023	–	

2. Pulse Test: Pulse Width ≤ 300 μs, Duty Cycle ≤ 2%.
3. Switching characteristics are independent of operating junction temperatures.
4. From characterization test data.

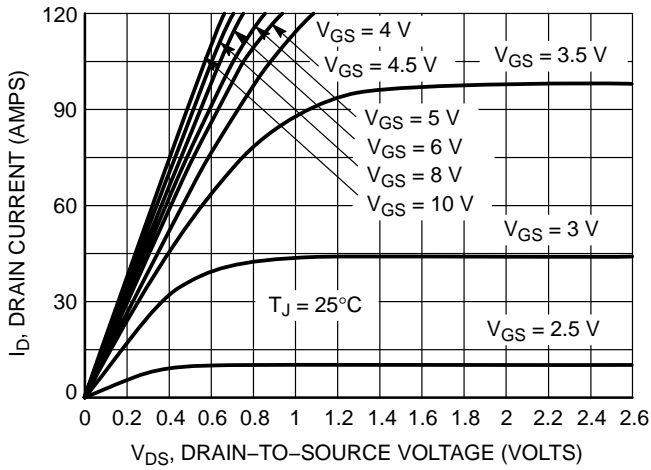

Figure 1. On-Region Characteristics

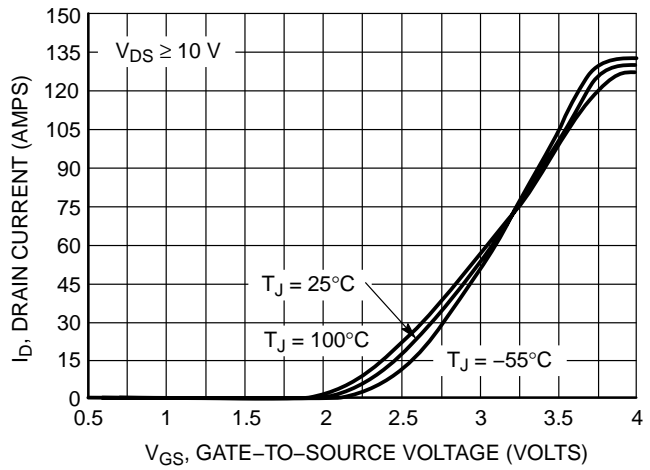

Figure 2. Transfer Characteristics

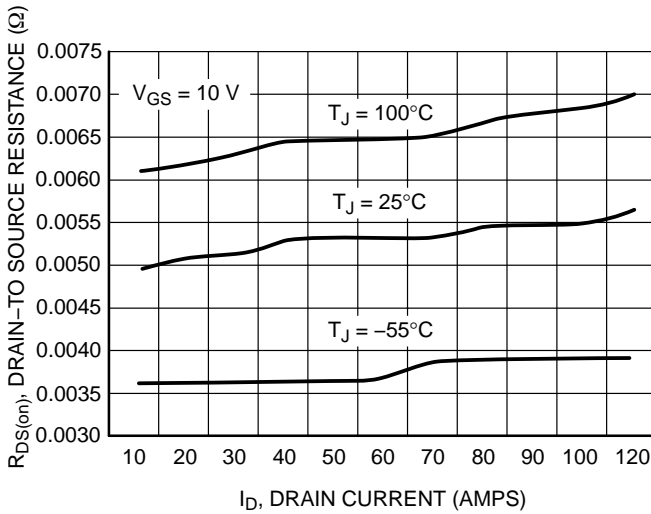

Figure 3. On-Resistance vs. Drain Current and Temperature

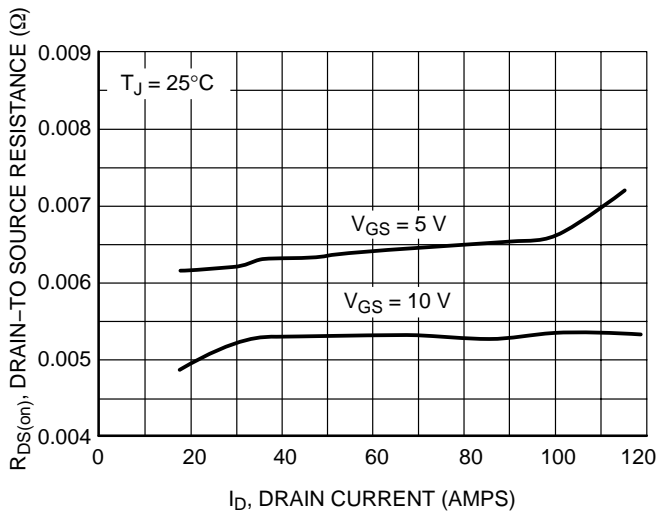

Figure 4. On-Resistance vs. Drain Current and Gate Voltage

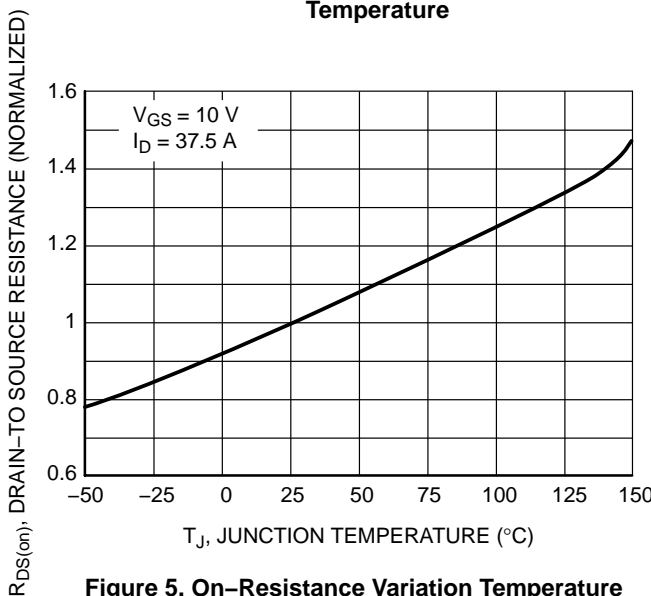

Figure 5. On-Resistance Variation Temperature

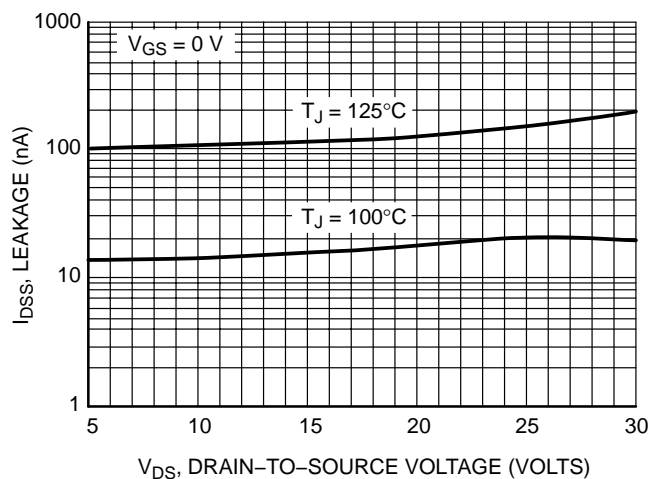

Figure 6. Drain-to-Source Leakage Current vs. Voltage

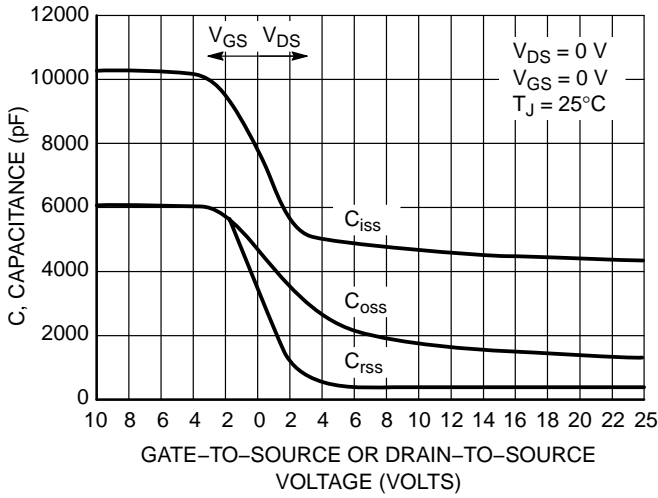

Figure 7. Capacitance Variation

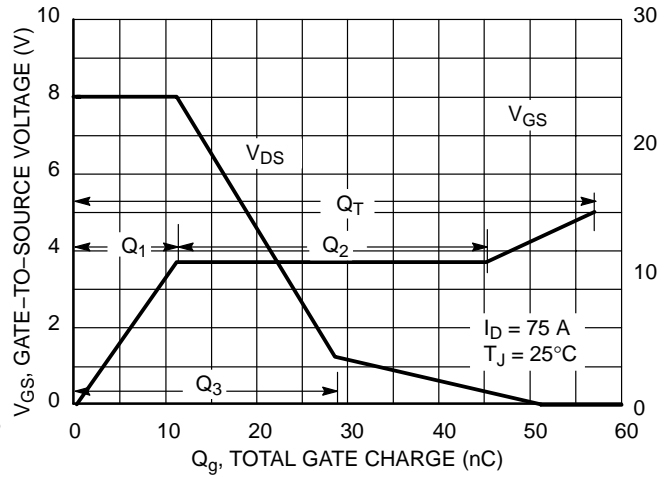

Figure 8. Gate-to-Source and Drain-to-Source Voltage vs. Total Charge

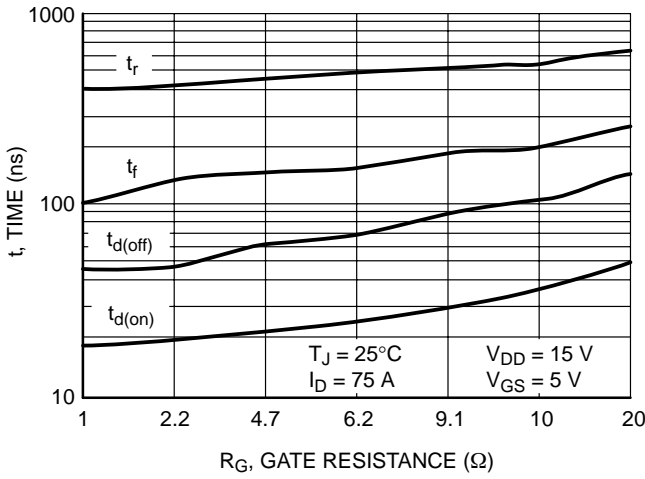

Figure 9. Resistive Switching Time Variation vs. Gate Resistance

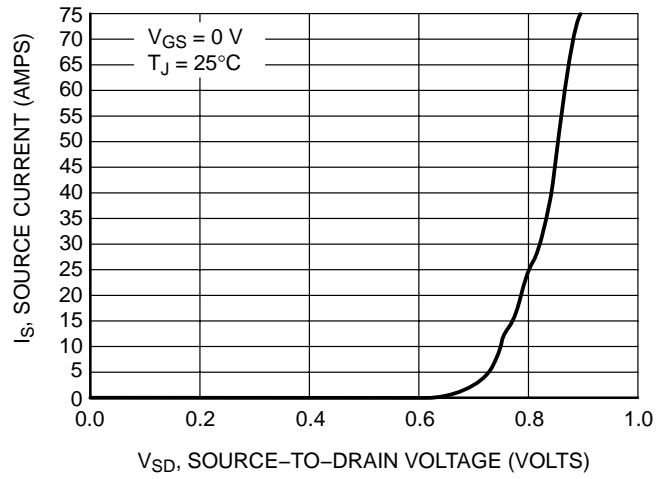

Figure 10. Diode Forward Voltage vs. Current

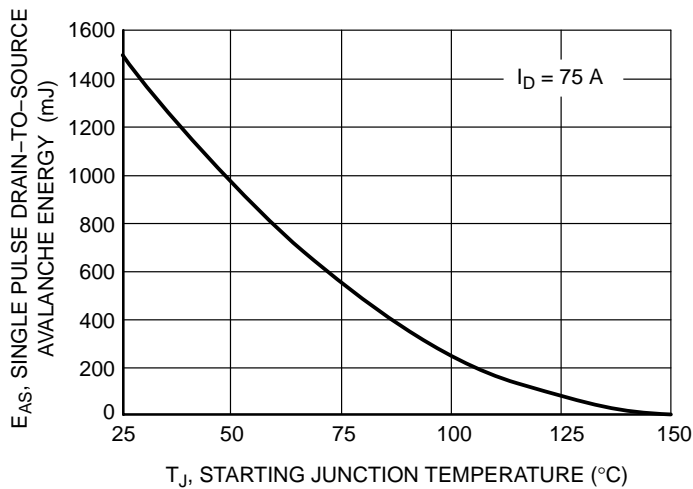
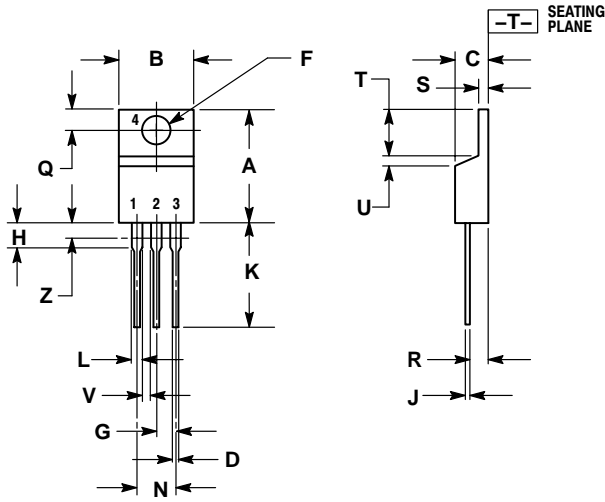

Figure 11. Maximum Avalanche Energy vs. Starting Junction Temperature

NTP75N03-06, NTB75N03-06

PACKAGE DIMENSIONS

TO-220 THREE-LEAD
TO-220AB
CASE 221A-09
ISSUE AA



- NOTES:
1. DIMENSIONING AND TOLERANCING PER ANSI Y14.5M, 1982.
 2. CONTROLLING DIMENSION: INCH.
 3. DIMENSION Z DEFINES A ZONE WHERE ALL BODY AND LEAD IRREGULARITIES ARE ALLOWED.

DIM	INCHES		MILLIMETERS	
	MIN	MAX	MIN	MAX
A	0.570	0.620	14.48	15.75
B	0.380	0.405	9.66	10.28
C	0.160	0.190	4.07	4.82
D	0.025	0.035	0.64	0.88
F	0.142	0.147	3.61	3.73
G	0.095	0.105	2.42	2.66
H	0.110	0.155	2.80	3.93
J	0.018	0.025	0.46	0.64
K	0.500	0.562	12.70	14.27
L	0.045	0.060	1.15	1.52
N	0.190	0.210	4.83	5.33
Q	0.100	0.120	2.54	3.04
R	0.080	0.110	2.04	2.79
S	0.045	0.055	1.15	1.39
T	0.235	0.255	5.97	6.47
U	0.000	0.050	0.00	1.27
V	0.045	---	1.15	---
Z	---	0.080	---	2.04

- STYLE 5:
PIN 1. GATE
2. DRAIN
3. SOURCE
4. DRAIN

PACKAGE DIMENSIONS

D²PAK
CASE 418AA-01
ISSUE O

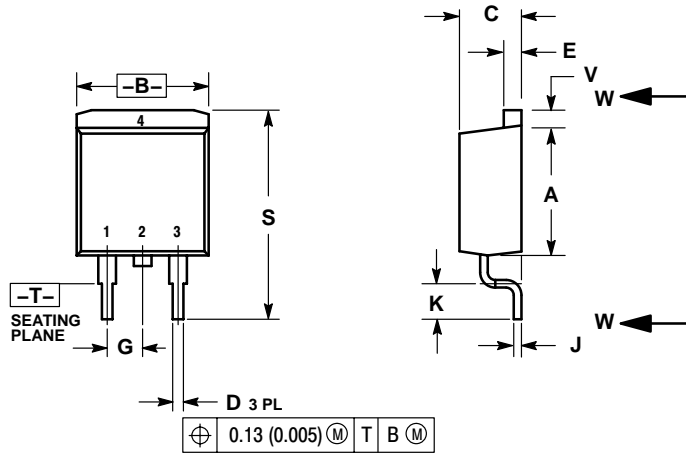

- NOTES:
1. DIMENSIONING AND TOLERANCING PER ANSI Y14.5M, 1982.
2. CONTROLLING DIMENSION: INCH.

DIM	INCHES		MILLIMETERS	
	MIN	MAX	MIN	MAX
A	0.340	0.380	8.64	9.65
B	0.380	0.405	9.65	10.29
C	0.160	0.190	4.06	4.83
D	0.020	0.036	0.51	0.92
E	0.045	0.055	1.14	1.40
F	0.310	---	7.87	---
G	0.100 BSC		2.54 BSC	
J	0.018	0.025	0.46	0.64
K	0.090	0.110	2.29	2.79
M	0.280	---	7.11	---
S	0.575	0.625	14.60	15.88
V	0.045	0.055	1.14	1.40

- STYLE 2:
PIN 1. GATE
2. DRAIN
3. SOURCE
4. DRAIN

SOLDERING FOOTPRINT*

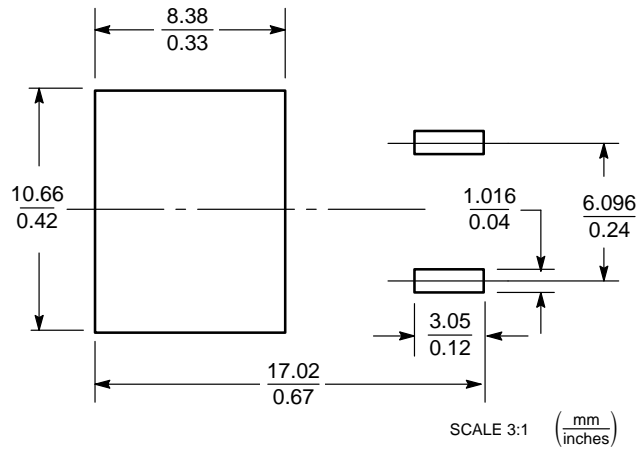



Figure 12. D²PAK

ON Semiconductor and  are registered trademarks of Semiconductor Components Industries, LLC (SCILLC). SCILLC reserves the right to make changes without further notice to any products herein. SCILLC makes no warranty, representation or guarantee regarding the suitability of its products for any particular purpose, nor does SCILLC assume any liability arising out of the application or use of any product or circuit, and specifically disclaims any and all liability, including without limitation special, consequential or incidental damages. "Typical" parameters which may be provided in SCILLC data sheets and/or specifications can and do vary in different applications and actual performance may vary over time. All operating parameters, including "Typicals" must be validated for each customer application by customer's technical experts. SCILLC does not convey any license under its patent rights nor the rights of others. SCILLC products are not designed, intended, or authorized for use as components in systems intended for surgical implant into the body, or other applications intended to support or sustain life, or for any other application in which the failure of the SCILLC product could create a situation where personal injury or death may occur. Should Buyer purchase or use SCILLC products for any such unintended or unauthorized application, Buyer shall indemnify and hold SCILLC and its officers, employees, subsidiaries, affiliates, and distributors harmless against all claims, costs, damages, and expenses, and reasonable attorney fees arising out of, directly or indirectly, any claim of personal injury or death associated with such unintended or unauthorized use, even if such claim alleges that SCILLC was negligent regarding the design or manufacture of the part. SCILLC is an Equal Opportunity/Affirmative Action Employer. This literature is subject to all applicable copyright laws and is not for resale in any manner.

PUBLICATION ORDERING INFORMATION

LITERATURE FULFILLMENT:

Literature Distribution Center for ON Semiconductor
P.O. Box 5163, Denver, Colorado 80217 USA

Phone: 303-675-2175 or 800-344-3860 Toll Free USA/Canada

Fax: 303-675-2176 or 800-344-3867 Toll Free USA/Canada

Email: orderlit@onsemi.com

N. American Technical Support: 800-282-9855 Toll Free
USA/Canada

Japan: ON Semiconductor, Japan Customer Focus Center
2-9-1 Kamimeguro, Meguro-ku, Tokyo, Japan 153-0051
Phone: 81-3-5773-3850

ON Semiconductor Website: <http://onsemi.com>

Order Literature: <http://www.onsemi.com/litorder>

For additional information, please contact your
local Sales Representative.