

SPS-53-FE-BX-xxC

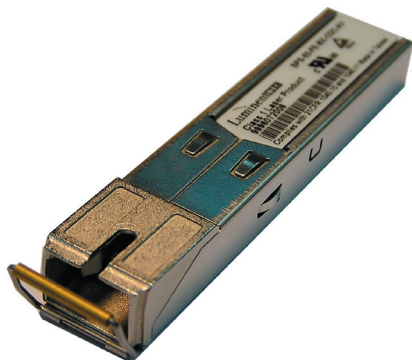

Features

- Compliant with OC3/STM-1, IEEE 802.3ah, 100BASE-BX10
- Simplex SC Connector
- Digital Diagnostic SFF-8472 Compliant
- SFP MSA SFF-8074i Compliant
- 14 dB Minimum Power Budget
- 10 km Typical reach
- Commercial and Industrial Temperature Available
- Single 3.3V Supply
- 1530 nm FP Laser
- Telcordia GR-468 Compliant
- Color Coded Yellow Bail Latch
- RoHS-6/6 compliant (lead free soldering) (-xxC)

General Operation

Parameter	Symbol	Min.	Typ.	Max.	Unit
Supply Voltage	V_{CC}	3.135	3.3	3.465	V
Total Current	I_{CC}	-	-	300	mA
Power Supply Noise Rejection		100	-	-	mVp-p
Operating Temperature (-Cxx)	T_{opr}	-5	-	70	°C
Operating Temperature (-Txx)	T_{opr}	-40	-	85	°C
Storage Temperature	T_{stg}	-40	-	85	°C
Data Rate	DR	10	-	155	Mbps

Transmitter Specifications (Optical)

Parameter	Symbol	Min	Typical	Max	Unit
Optical power	P_{op}	-14	-11	-8	dBm
Optical crosstalk	XT	-	-45	-40	dB
Average Launch power of off Tx	P_{off}	-	-	-45	dBm
Extinction Ratio	ER	6.6	-	-	dB
Eye Mask		IEEE 802.3 and SONET/SDH Compliant			
Optical Rise time (20% to 80% values)	t_r	-	-	2	ns
Optical Fall time (20% to 80% values)	t_f	-	-	2	ns
Mean Wavelength	λ	1480	1530	1580	nm
Spectral Width (RMS)	σ	2	-	4	nm
Relative Intensity Noise	RIN	-	-	-120	dB/Hz
Optical Return Loss Tolerance	ORLT	-	-	12	dB

SPS-53-FE-BX-xxC

Transmitter Specifications (Electrical)

Parameter	Symbol	Min	Typical	Max	Unit
Input Differential Impedence	R_{in}	80	100	120	Ω
PECL Single Ended data input swing	$V_{in, p-p}$	250	-	1200	mV
TxFault_Fault	V_{fault}	2	-	V_{cc}	V
TxFault_Normal	V_{normal}	V_{ee}	-	$V_{ee} + 0.5$	V
TxDisable_Disable	V_d	2	-	V_{cc}	V
TxDisable_Enable	V_{en}	V_{ee}	-	$V_{ee} + 0.8$	V

Receiver Specifications (Optical)

Parameter	Symbol	Min	Typical	Max	Unit
Receiver Power Low ^a	$R_{sens,low}$	-	-30	-28.2	dBm
Receiver Power High	$R_{sens,high}$	-8	-	-	dBm
Damage Threshold for Receiver	$P_{in, damage}$	4	-	-	dBm
Wavelength	λ	1260	-	1360	nm
LOS Assert	-	-45	-	-	dBm
LOS De-assert	-	-	-	-28.2	dBm
LOS hysteresis	-	1	-	-	dB

a) at 10^{-12} BER, PRBS 27-1

Receiver Specifications (Electrical)

Parameter	Symbol	Min	Typical	Max	Unit
CML Single ended data output swing	$V_{out,p-p}$	185	-	800	mV
Data output rise time	t_r	-	-	2	ns
Data output fall time	t_f	-	-	2	ns

Timing and Electrical

Parameter	Symbol	Min	Typical	Max	Unit
Tx Disable Negate time	t_{on}	-	-	25	ms
Tx Disable assert time	t_{off}	-	-	10	μ s
Time to initialize, including reset of Tx fault	t_{init}	-	-	300	ms
Tx fault Assert time	t_{fault}	-	-	100	μ s
Tx Disable to reset	t_{reset}	10	-	-	μ s
LOS Assert time	t_{loss_on}	-	-	1000	μ s
LOS De-assert time	t_{loss_off}	-	-	100	μ s
Serial ID Clock Rate	f_{serial_clock}	-	-	100	KHz
RX_LOS Voltage (high)	RX_LOS_H	2	-	-	V
RX_LOS Voltage (low)	RX_LOS_L	-	-	0.8	V
LOS output voltage-Fault	$V_{LOS\ fault}$	2	-	V_{cc}	V
LOS output voltage-Normal	$V_{LOS\ normal}$	V_{ee}	-	$V_{ee} + 0.5$	V
MOD_DEF (0:2)-High	V_h	2	-	V_{cc}	V
MOD_DEF (0:2)-Low	V_l	V_{ee}	-	$V_{ee} + 0.5$	V

SPS-53-FE-BX-xxC

Diagnostics

Parameter	Range	Accuracy	Unit	Calibration	Bit Value	Formula
Temperature (CDC)	-5 to 70	±3	°C	Internal	1/256 C	$T_c(C) = T_{ad}(16 \text{ bit signed twos complement})/256$
Temperature (TDC)	-40 to 85	±3	°C	Internal	1/256 C	$T_c(C) = T_{ad}(16 \text{ bit signed twos complement})/256$
Voltage	0 to V _{cc}	.1	V	Internal	100µV	$V(\text{Volts}) = V_{ad}(16 \text{ bit unsigned integer}) * 0.1$
Bias Current	0 to 120	5	mA	External	-	$I(\text{mA}) = I_{slope} * I_{ad}(16 \text{ bit unsigned integer}) + I_{offset}$
Tx Power	-14 to -8	±3	dBm	External	-	$Tx_PWR(\mu W) = Tx_PWR_{slope} * Tx_PWR_{ad}(16 \text{ bit unsigned integer}) + Tx_PWR_{offset}$
Rx Power	-28.2 to -8	±3	dBm	External	-	$Rx_PWR(\mu W) = A_0 + A_1 * x + A_2 * x^2 + A_3 * x^3 + A_4 * x^4$

Pinout Definitions

Pin	Function	Notes
1	V _{ee} T	TX GND
2	TX_FAULT	Open Collector
3	TX_DISABLE	Internally Pulled High
4	MOD_DEF2	Serial Data Input
5	MOD_DEF1	Serial Clock Input
6	MOD_DEF0	Internally Grounded
7	NC	Not Connected
8	LOS	Open Collector
9	V _{ee} R	RX Ground
10	V _{ee} R	RX Ground
11	V _{ee} R	RX Ground
12	RXD-	RX Data Negative
13	RXD+	RX Data Positive
14	V _{ee} R	RX GND
15	V _{CC} R	RX Power
16	V _{CC} T	TX Power
17	V _{ee} T	TX GND
18	TXD+	TX Data Positive
19	TXD-	TX Data Negative
20	V _{ee} T	TX GND

SPS-53-FE-BX-xxC

EEPROM Serial ID				
Name of Field	Discription of Field	Address	Hex	ASCII
Vendor Name	SFP Vendor name (ASCII)	20	4C	L
		21	55	U
		22	40	M
		23	49	I
		24	4E	N
		25	45	E
		26	4E	N
		27	54	T
		28	4F	O
		29	49	I
		30	43	C
Vendor OUI	IEEE vendor OUI code for LuminentOIC	37	00	
		38	06	
		39	B5	
Vendor PN	Part number in ASCII, e.g. SPS-53-FE-BX-CDC	40	53	S
		41	50	P
		42	53	S
		43	35	5
		44	33	3
		45	46	F
		46	45	E
		49	42	B
		50	58	X
		51	43	C
		52	44	D
		53	43	C

SC Connector Mechanical

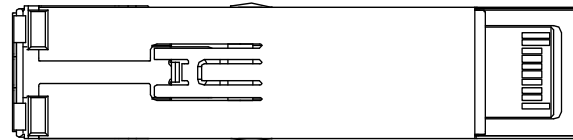
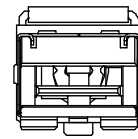
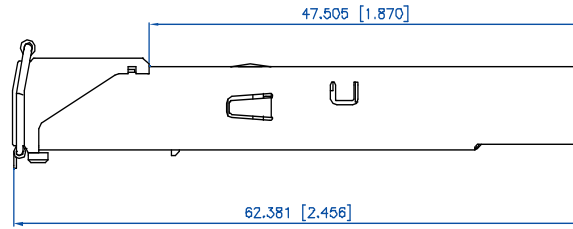
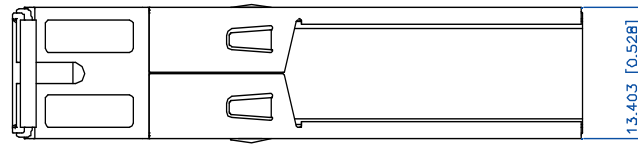
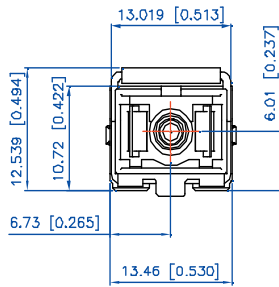

Units in mm(inches)

SPS-53-FE-BX-xxC

Suggested Transceiver Interface

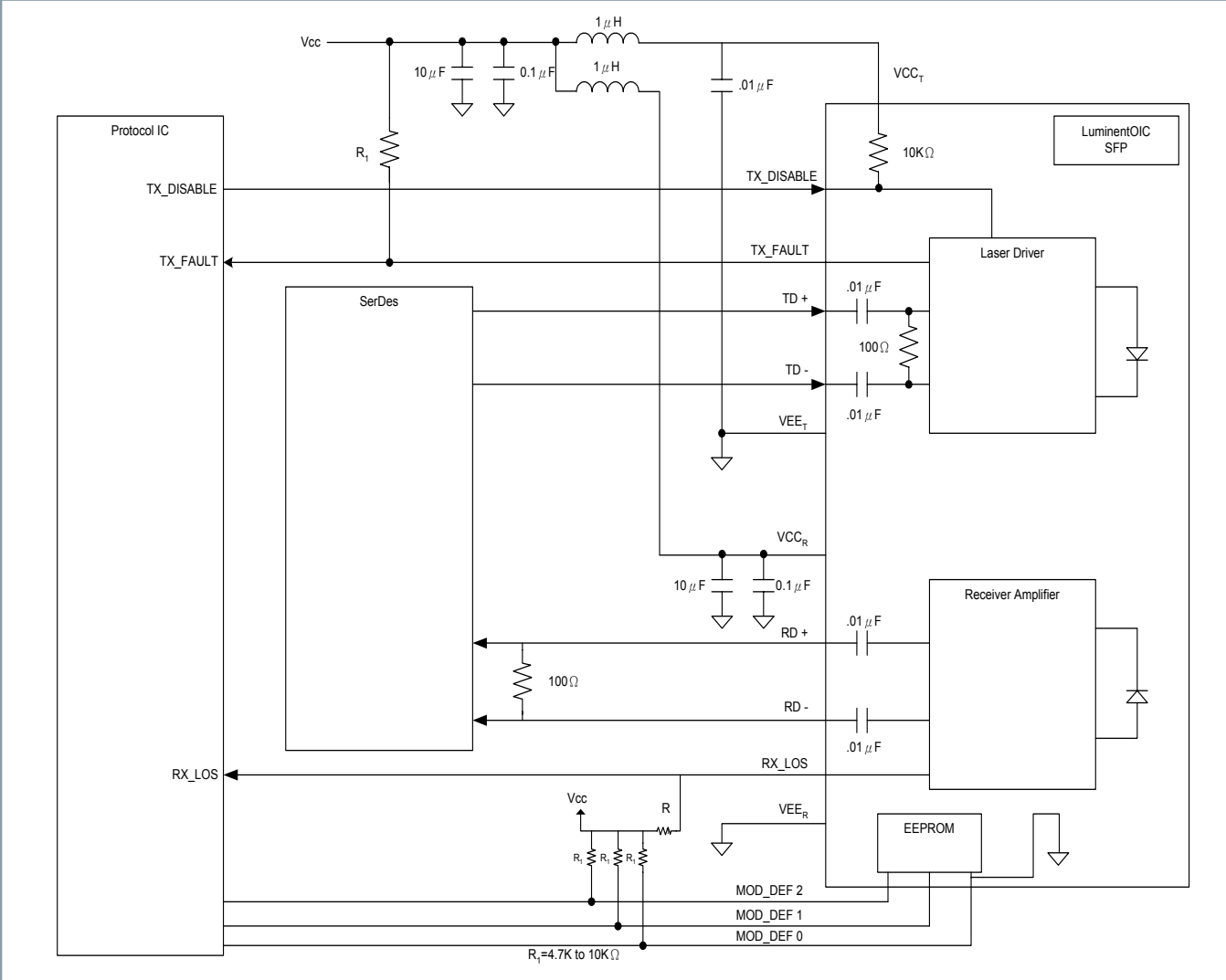

SPS-53-FE-BX-xxC

Ordering Information

Available Options:

- SPS-53-FE-BX-CDC
- SPS-53-FE-BX-TDC
- SPS-53-FE-BX-CNC
- SPS-53-FE-BX-TNC

Part numbering Definition:

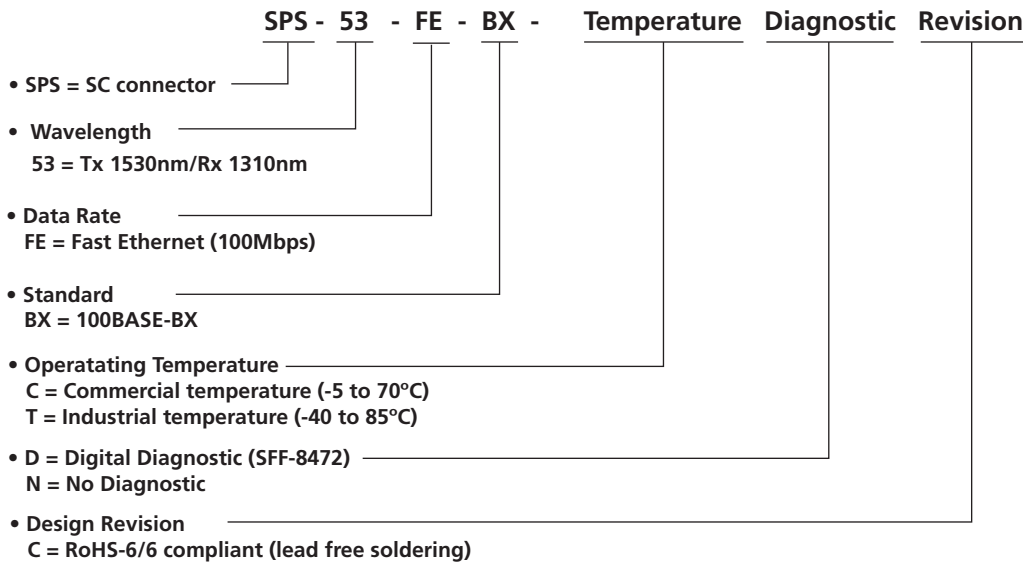

Warnings:

Handling Precautions: This device is susceptible to damage as a result of electrostatic discharge (ESD). A static free environment is highly recommended. Follow guidelines according to proper ESD procedures.

Laser Safety: Radiation emitted by laser devices can be dangerous to human eyes. Avoid eye exposure to direct or indirect radiation.

Legal Notes:

IMPORTANT NOTICE!
All information contained in this document is subject to change without notice, at LuminentOIC’s sole and absolute discretion. LuminentOIC warrants performance of its products to current specifications only in accordance with the company’s standard one-year warranty; however, specifications designated as “preliminary” are given to describe components only, and LuminentOIC expressly disclaims any and all warranties for said products, including express, implied, and statutory warranties, warranties of merchantability, fitness for a particular purpose, and non-infringement of proprietary rights. Please refer to the company’s Terms and Conditions of Sale for further warranty information.

LuminentOIC assumes no liability for applications assistance, customer product design, software performance, or infringement of patents, services, or intellectual property described herein. No license, either express or implied, is granted under any patent right, copyright, or intellectual property right, and LuminentOIC makes no representations or warranties that the product(s) described herein are free from patent, copyright, or intellectual property rights. Products described in this document are NOT intended for use in implantation or other life support applications where malfunction may result in injury or death to persons. LuminentOIC customers using or selling products for use in such applications do so at their own risk and agree to fully defend and indemnify LuminentOIC for any damages resulting from such use or sale.

THE INFORMATION CONTAINED IN THIS DOCUMENT IS PROVIDED ON AN “AS IS” BASIS. Customer agrees that LuminentOIC is not liable for any actual, consequential, exemplary, or other damages arising directly or indirectly from any use of the information contained in this document. Customer must contact LuminentOIC to obtain the latest version of this publication to verify, before placing any order, that the information contained herein is current.

© LuminentOIC, Inc. 2003
All rights reserved