

## General Description

The MIC5231  $\mu$ Cap low-dropout voltage regulator is intended for low-output-current biasing applications. It features extremely low ground current, not greater than 4 $\mu$ A under all load and temperature conditions, making it efficient and ideal for keep-alive applications in devices such as notebook computers.

The MIC5231 offers better than 2% initial accuracy and low dropout (typically 150mV at 10mA output current). An output capacitor is not required for stable operation, decreasing cost and board space. Tiny ceramic chip capacitors may be used to improve transient response.

The MIC5231 also features a control pin which allows the regulator to be shut down when not required. Its shutdown-state draws zero current, benefitting battery-powered applications.

The MIC5231 is available in fixed output voltages of 2.75V, 3.0V, 3.3V and 5V in the small SOT-23-5 IttyBitty™ package. Contact Micrel for other voltage options.

## Features

- Extremely low quiescent current—**only 0.65 $\mu$ A**
- **No output capacitor requirement**
- Stable with ceramic or tantalum capacitors
- IttyBitty™ SOT-23-5 surface-mount package
- 10mA output drive
- Low 150mV at 10mA dropout voltage
- Tight load and line regulation
- Low temperature coefficient
- Logic-level enable input

## Applications

- Real time clocks
- SRAM backup
- Cellular telephones
- Laptop, notebook and palmtop computers
- Battery-powered equipment
- Bar code scanners
- SMPS post-regulator and dc-to-dc modules

## Ordering Information

Part Number	Marking	Voltage	Temperature Range	Package
MIC5231-2.75BM5	LM2H	2.75V	-40°C to +125°C	SOT-23-5
MIC5231-3.0BM5	LM30	3.0V	-40°C to +125°C	SOT-23-5
MIC5231-3.3BM5	LM33	3.3V	-40°C to +125°C	SOT-23-5
MIC5231-5.0BM5	LM50	5.0V	-40°C to +125°C	SOT-23-5

## Typical Application

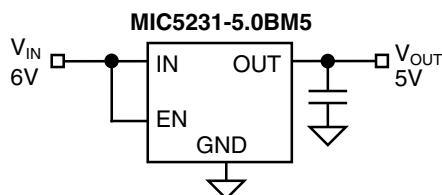

5V Linear Regulator Application

## Pin Configuration

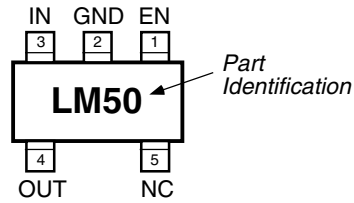

**MIC5231-5.0BM5**

## Pin Description

Pin Number	Pin Name	Pin Function
1	EN	Enable (Input): Active high. Logic high = enable; logic low = shutdown. Do not float.
2	GND	Ground
3	IN	Supply Input
4	OUT	Regulated Output
5	NC	not internally connected

### Absolute Maximum Ratings (Note 1)

Supply Voltage ( $V_{IN}$ ) ..... -0.6V to +14V  
 Lead Temperature (soldering, 5 sec.) ..... 260°C  
 Storage Temperature ( $T_A$ ) ..... -60°C to +150°C  
 ESD, **Note 3** ..... 2kV

### Operating Ratings (Note 2)

Input Voltage ( $V_{IN}$ ) ..... 3.5V to 12V  
 Ambient Temperature ( $T_A$ ) ..... -40°C to +85°C  
 Junction Temperature ( $T_J$ ) ..... -40°C to +125°C  
 Thermal Resistance, **Note 4**

## Electrical Characteristics

$V_{IN} = V_{OUT} + 1V$ ;  $I_L = 100\mu A$ ;  $C_L = 0.47\mu F$ ;  $T_J = 25^\circ C$ , **bold** values indicate  $-40^\circ C \leq T_J \leq +125^\circ C$ ; unless noted.

Symbol	Parameter	Conditions	Min	Typ	Max	Units
$V_{OUT}$	Output Voltage Accuracy	variation from nominal $V_{OUT}$	-2 <b>-3</b>		+2 <b>+3</b>	% %
$\Delta V_{OUT}/\Delta T$	Output Voltage Temperature Coefficient	<b>Note 5</b>		250		ppm/ $^\circ C$
$\Delta V_{OUT}/V_{OUT}$	Line Regulation	$V_{IN} = 6V$ to $12V$		0.2	0.25	%
$\Delta V_{OUT}/V_{OUT}$	Load Regulation	$I_L = 10\mu A$ to $10mA$ , <b>Note 6</b>		0.2	1	%
$V_{DO}$	Dropout Voltage, <b>Note 7</b>	$I_L = 1mA$		15		mV
		$I_L = 10mA$		150	300	mV
$I_Q$	Ground Pin Current	$V_{IN} = 6V$ , $I_L = 10mA$		0.65	3	$\mu A$
		$V_{IN} = 12V$ , $I_L = 10mA$		1.1	<b>4</b>	$\mu A$
PSRR	Ripple Rejection	$f = 100Hz$ , $I_L = 100\mu A$		50		dB

### Enable Input

$V_{ENL}$	Enable Input Voltage	$V_{EN} = \text{logic low (regulator off)}$		0.4	<b>0.18</b>	V
		$V_{EN} = \text{logic high ((regulator on)}$	<b>1.4</b>			V
$I_{ENL}$	Enable Input Current	$V_{ENL} \leq 0.18V$ (regulator off)		1		nA
$I_{ENH}$	Enable Input Current	$V_{ENH} \geq 1.4V$ (regulator on)		1		nA

**Note 1.** Exceeding the absolute maximum rating may damage the device.

**Note 2.** The device is not guaranteed to function outside its operating rating.

**Note 3.** Devices are ESD sensitive. Handling precautions recommended.

**Note 4:** The maximum allowable power dissipation at any  $T_A$  (ambient temperature) is  $P_{D(max)} = (T_{J(max)} - T_A) \div \theta_{JA}$ . The  $\theta_{JC}$  of the MIC5231 is  $130^\circ C/W$ . Mounted to a standard PC board, the  $\theta_{JA}$  is approximately  $235^\circ C/W$ .

**Note 5:** Output voltage temperature coefficient is defined as the worst case voltage change divided by the total temperature range.

**Note 6:** Regulation is measured at constant junction temperature using low duty cycle pulse testing.

**Note 7:** Dropout voltage is defined as the input to output differential at which the output voltage drops 2% below its nominal value measured at 1V differential. For outputs below 3.5V, dropout voltage is the input-to-output differential with the minimum input voltage 3.5V. Minimum input operating voltage is 3.5V.

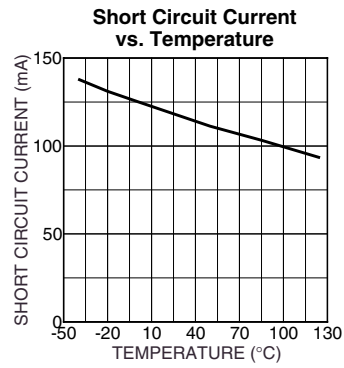
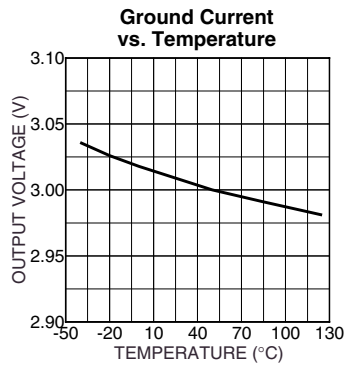
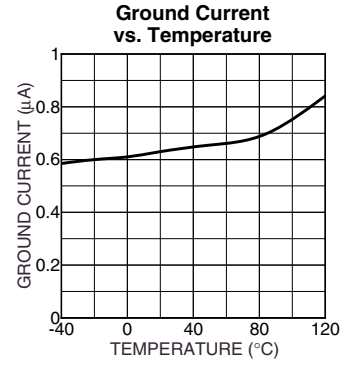
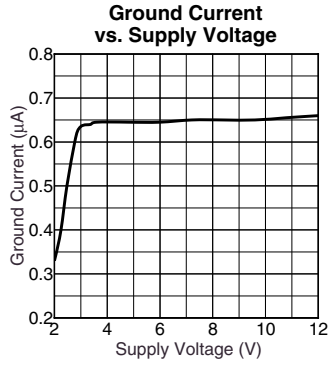
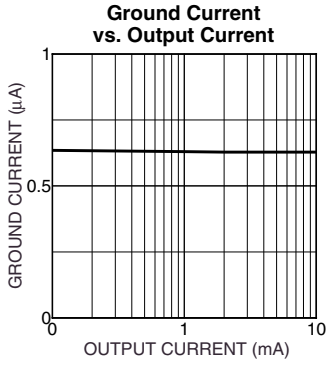

## Block Diagram

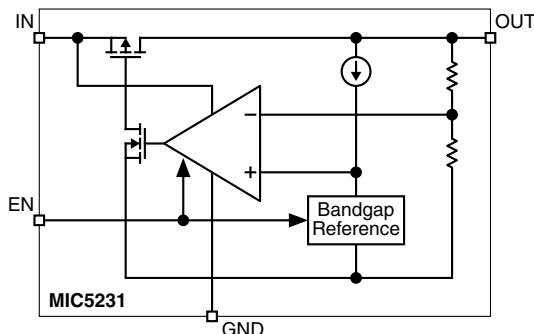

## Applications Information

### Input Capacitor

A 0.1 $\mu$ F (or larger) capacitor should be placed from the IN (supply input) to GND (ground) if there is more than 20 cm of wire between IN and the ac filter capacitor or if supplied from a battery.

### Output Capacitors

The MIC5231 does not require an output capacitor for stability. A 1 $\mu$ F or larger capacitor is recommended between OUT (output) and GND to improve the regulator's transient response. A 0.1 $\mu$ F capacitor can be used to reduce overshoot recovery time at the expense of overshoot amplitude. The ESR (effective series resistance) of this capacitor has no effect on regulator stability, but low-ESR capacitors improve high frequency transient response. The value of this capacitor may be increased without limit, but values larger than 10 $\mu$ F tend to increase the settling time after a step change in input voltage or output current.

The MIC5231 has no minimum load current; it will remain stable and in regulation with no load (other than the internal voltage divider). This is especially important in real-time clock and CMOS RAM keep-alive applications.

### Minimum Load Current

The MIC5231 does not require a minimum load for proper operation. This allows the device to operate in applications where very light output currents are required for keep-alive purposes. This is important for powering SRAM or Flash memory in low-power modes for handheld devices.

## Safe Operating Conditions

The MIC5231 does not incorporate current limit or thermal shutdown in the design. The output pass element is approximately 15 ohms, therefore, when a short occurs from the output to ground, the current is self-limited. The pass element has a positive temperature coefficient, such that when the device gets hot, the output impedance goes up, limiting the current even further. The maximum junction temperature for the device is 125°C, and it is important that this is not exceeded for any length of time.

## Thermal Considerations

The MIC5231 is not intended for sourcing currents that would cause a large power loss in the device, but since it is not current limited, it is possible to source more than the rated 10mA. At this point, it is important to ensure that the die temperature does not exceed 125°C.

Power dissipation in the regulator is calculated as follows:

$$P_D = (V_{IN} - V_{OUT}) * I_{OUT} + V_{IN} * I_{GND}$$

The MIC5231 consumes only 0.65 $\mu$ A over load and does not need to consider that contribution in the power dissipation equation, therefore the equation is simplified.

$$P_D = (V_{IN} - V_{OUT}) * I_{OUT}$$

The MIC5231, in the IttyBitty SOT23-5 package, has a thermal resistance, junction-to-ambient, of 235°C/W. Using this number, the power dissipation capability of that package, without exceeding a 125°C junction temperature rating, can easily be calculated.

$$P_{D(max)} = (T_{j(max)} - T_a) / \theta_{JA}$$

$$P_{D(max)} = (125^\circ\text{C} - T_a) / 235^\circ\text{C/W}$$

If the device is being operated at 85°C, the maximum power

dissipation allowed can easily be determined.

$$P_{D(\max)} = (125^{\circ}\text{C} - 85^{\circ}\text{C})/235^{\circ}\text{C}/\text{W}$$

$$P_{D(\max)} = 170\text{mW}$$

Therefore, the device can only dissipate 170mW maximum. If the MIC5231 is powered off of a 12V source and the output voltage is 3.3V, the maximum output current can be calculated.

$$P_D = (V_{in} - V_{out}) \cdot I_{out}$$

$$170\text{mW} = (12\text{V} - 3.3\text{V}) \cdot I_{out}$$

$$I_{out} = 170\text{mW}/8.7\text{V}$$

$$I_{out} = 19.5\text{mA}$$

Therefore, the device can source almost 20mA at an ambient of 85°C before the die temperature exceeds 125°C.

Package Information

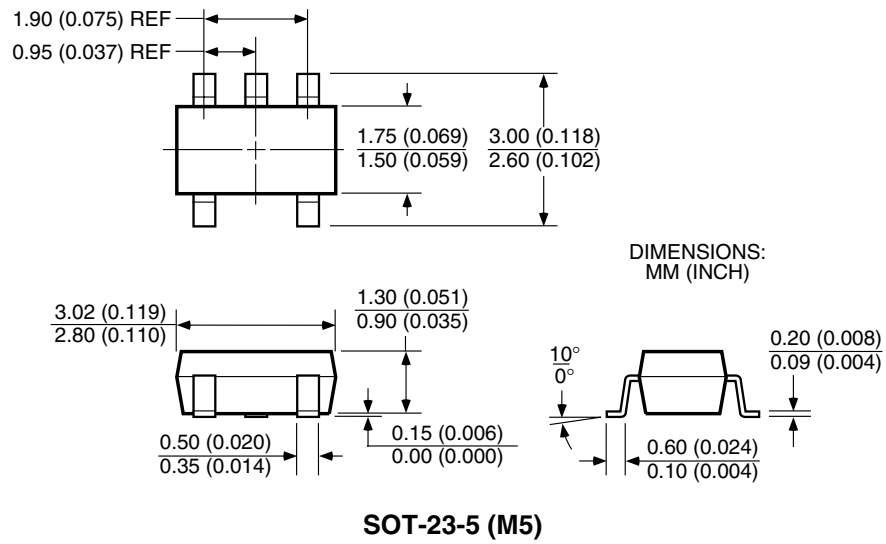

---

**MICREL INC. 1849 FORTUNE DRIVE SAN JOSE, CA 95131 USA**

TEL + 1 (408) 944-0800 FAX + 1 (408) 944-0970

This information is believed to be accurate and reliable, however no responsibility is assumed by Micrel for its use nor for any infringement of patents or other rights of third parties resulting from its use. No license is granted by implication or otherwise under any patent or patent right of Micrel Inc.

© 2000 Micrel Incorporated