

Toggle Switches

High Capacity Toggle Switches up to 20A

TK70 Series



TK70S1A3B2T2

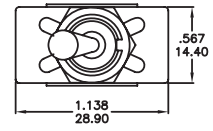
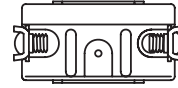
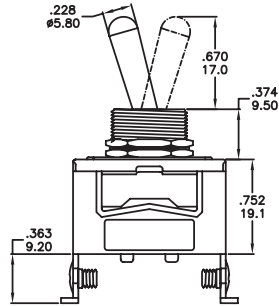

TK70S3A3B2T2

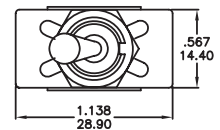
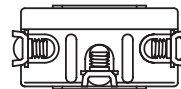
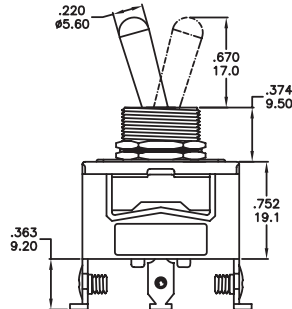

TK70D1A3B2T2

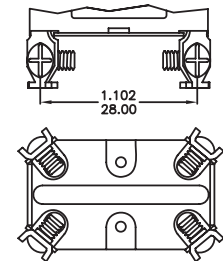
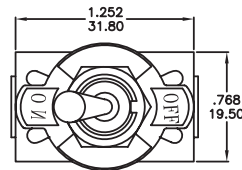
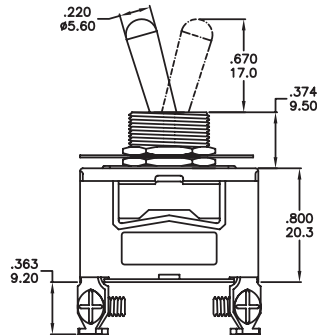

TK70D3A3B2T2

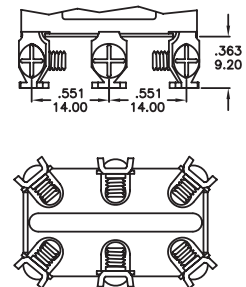
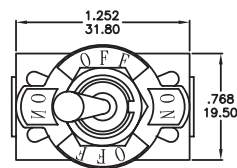
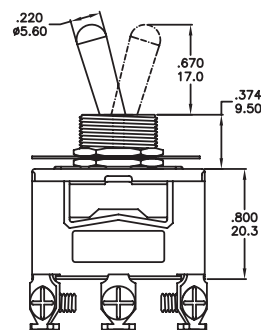

How to order:

TK70 1 2 3 4

- 1 POLES & CIRCUIT:**
 S1 SP OFF-NONE-ON
 S2 SP OFF-NONE-MOM
 S3 SP ON-NONE-ON
 S4 SP MOM-NONE-ON
 S5 SP ON-OFF-ON
 S6 SP MOM-OFF-ON
 S7 SP MOM-OFF-MOM

- D1 SP OFF-NONE-ON
 D2 SP OFF-NONE-MOM
 D3 SP ON-NONE-ON
 D4 SP MOM-NONE-ON
 D5 SP ON-OFF-ON
 D6 SP MOM-OFF-ON
 D7 SP MOM-OFF-MOM

- T1 3P OFF-NONE-ON
 F1 4P OFF-NONE-ON
- 2 ACTUATOR:**
 A1 See Drawings
 A2 See Drawings
 A3 See Drawings
 A4 See Drawings

- 3 BUSHING:**
 B1 See Drawings
 B2 See Drawings
 B3 See Drawings
 B4 See Drawings

- 4 TERMINALS:**
 T1 See Drawings
 T2 See Drawings
 T3 See Drawings
 T4 See Drawings
 T5 See Drawings

Toggle Switches

High Capacity Toggle Switches up to 20A

TK70 Series

SPECIFICATIONS

RATING: 20A 125VAC 15A 125/250VAC 10A 250VAC
INSULATION RESISTANCE: DC 500V 200MΩ Min.
CONTACT RESISTANCE: DC 2-4V 1A 20mΩ Max.
WITHSTAND VOLTAGE: AC 1500V Min.

SWITCH FUNCTION

NO. POLES	MODEL NO.	SWITCH FUNCTION			CONNECTED TERMINALS /SCHEMATIC		
		POS.1	POS.2	POS.3	POS.1	POS.2	POS.3
SP	TK70S1	OFF	NONE	ON	OPEN	N/A	1-3
	TK70S2	OFF	NONE	MOM			
	TK70S3	ON	NONE	ON			
	TK70S4	MOM	NONE	ON	2-3	OPEN	2-1
	TK70S5	ON	OFF	ON	1-3 RECOMM 5/3		1-3 RECOMM 5/3
	TK70S6	MOM	OFF	ON			
	TK70S7	MOM	OFF	MOM			
DP	TK70D1	OFF	NONE	ON	OPEN	N/A	1-3 4-6
	TK70D2	OFF	NONE	MOM			
	TK70D3	ON	NONE	ON			
	TK70D4	MOM	NONE	ON	2-3,5-6	OPEN	2-1,5-4
	TK70D5	ON	OFF	ON	1-3 RECOMM 5/3		1-3 RECOMM 5/3
	TK70D6	MOM	OFF	ON			
	TK70D7	MOM	OFF	MOM			
3P	TK70T1	OFF	NONE	ON	2-3,5-6 8-9,	OPEN	1-2,4-5 7-8,
4P	TK70F1	OFF	NONE	ON	2-3, 5-6 8-9,11-12	OPEN	1-2, 4-5 7-8,10-11

MOM=MOMENTARY

ACTUATOR OPTIONS

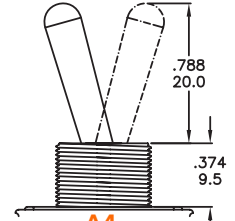
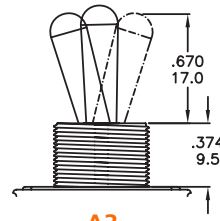
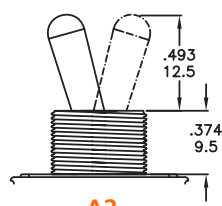
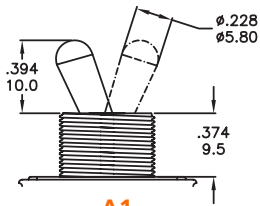

BUSHING OPTIONS

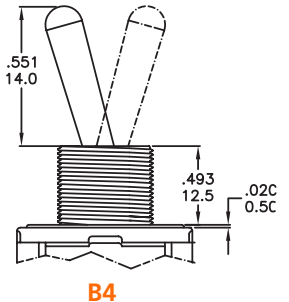
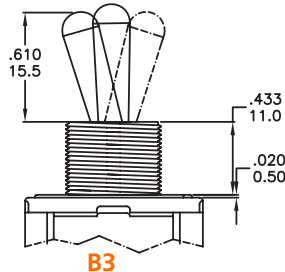
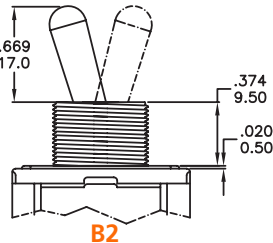
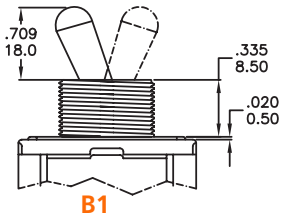

TERMINATION OPTIONS

