

FM IF DETECTOR/AMPLIFIER

FEATURES

- IF Input Frequency ~90 MHz (TYP)
- Balanced Input (IF)
- Includes Dual High Speed RSSI Outputs. One is for ASK demodulation, another one is for carrier sensing.
- RSSI outputs are accurate with stable temperature characteristic and include buffer amplifiers.
- High Speed RSSI Comparator for Carrier Sensing
- High Speed Data Comparator (~2 Mbps)
- Wide Band Demodulator (~1 MHz)
- Battery Save Function
- Low Voltage Operation: 3.0 ~ 5.5 V
- Very Small Package (TSSOP-24)

DESCRIPTION

The TK14551V is a wide band IF IC capable of operating up to 90 MHz. It includes an FM demodulator, RSSI, RSSI comparator and data comparator. These functions can perform high-speed operations. The TK14551V has a unique function that allows establishing the demodulation characteristics by changing the external RC time constant, and not changing the phase shifter constant. The RSSI output is individually trimmed, resulting in excellent accuracy, good linearity, and stable temperature characteristics. Because the TK14551V includes a dual high-speed RSSI output, it is possible to demodulate AM simply and to sense the carrier level at the same time.

Therefore, the TK14551V is suitable for high-speed data communication and can be used for various applications.

The TK14551V is available in the very small TSSOP-24 surface mount package.

APPLICATIONS

- Wide Band FSK Demodulation
- Wide Band FM Demodulation
- Video Signal Demodulation
- Wide Band ASK Demodulation

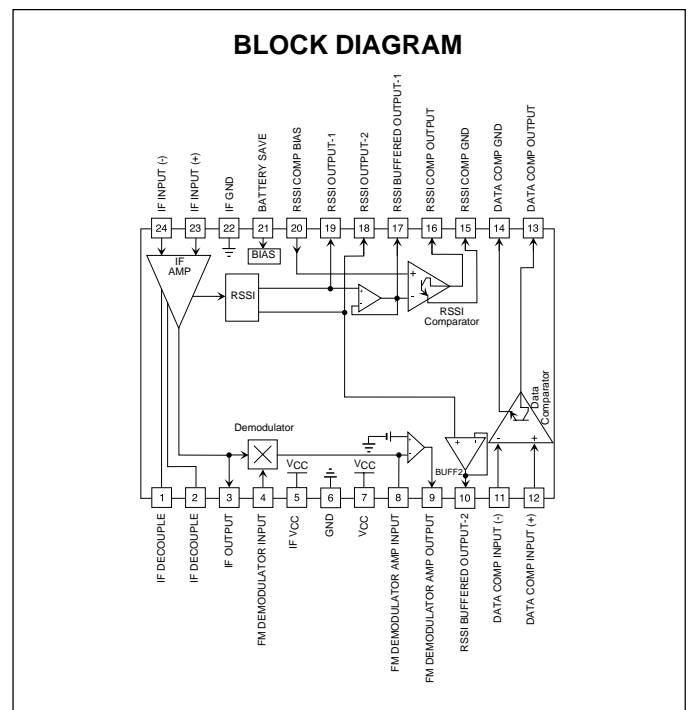
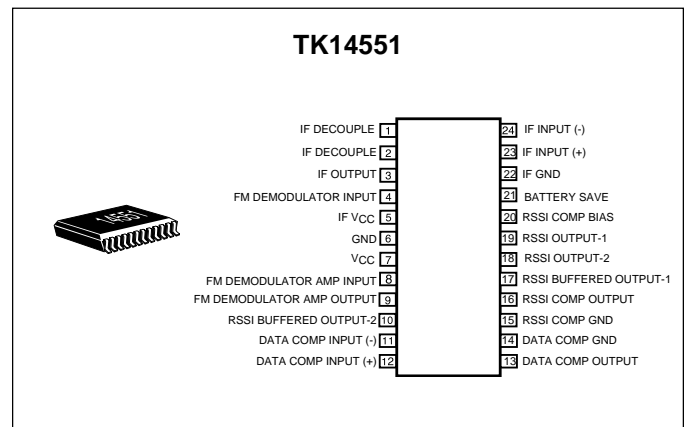

ORDERING INFORMATION

TK14551V

Tape/Reel Code

TAPE/REEL CODE
TL: Tape Left

TK14551V

ABSOLUTE MAXIMUM RATINGS

Supply Voltage	6 V	Storage Temperature Range	-55 to +150 °C
Operating Voltage Range	3.0 to 5.5 V	Operating Temperature Range	-40 to +85 °C
Power Dissipation (Note 1)	230 mW	Operating Frequency Range	0.1 to 90 MHz (typ.)

TK14551V ELECTRICAL CHARACTERISTICS

Test conditions: $V_{CC} = 3\text{ V}$, $T_A = 25\text{ °C}$, unless otherwise specified.

SYMBOL	PARAMETER	TEST CONDITIONS	MEASUREMENT POINT (NOTE 2)	MIN	TYP	MAX	UNITS
I_{CC}	Supply Current	Battery Save = OFF, Not including comparator output current.	A1	6	10	15	mA
		Battery Save = ON, Not including comparator output current.	A1		0.1	5.0	μA
V_{SON}	Battery Save On	Voltage at Pin 21 for standby mode		-0.1		0.2	V_{DC}
V_{SOFF}	Battery Save Off	Voltage at Pin 21 for operation mode		2.0		V_{CC}	V_{DC}
FM DEMODULATION ($f_{IN} = 10.7\text{ MHz}$)							
Limit	Limiting Sensitivity	-3 dB Point, 1 kHz \pm 100 kHz dev	VA		-65	-59	dBm
$V_{OUT(DET)}$	Demodulation Output Voltage	1 kHz \pm 100kHz dev, -20 dBm input	VA	60	100	160	mVrms
THD	Distortion		VA		0.5	2.0	%
S/N	Signal to Noise Ratio		VA	55	65		dB
f_{DB1}	Demodulating Frequency Band	Remove capacitor between Pin 8 and Pin 9. Standard measured value at 1 kHz	VA	1	1.5		MHz

Note 1: Power dissipation is 230 mW in free air. Derate at 1.84 mW/°C for operation above 25°C.

Note 2: Refer to Test Circuit.

TK14551V ELECTRICAL CHARACTERISTICSTest conditions: $V_{CC} = 3\text{ V}$, $T_A = 25\text{ }^\circ\text{C}$, unless otherwise specified.

SYMBOL	PARAMETER	TEST CONDITIONS	MEASUREMENT POINT (NOTE 2)	MIN	TYP	MAX	UNITS
RSSI OUTPUT ($f_{IN} = 40\text{ MHz}$)							
V_{RSSI}	RSSI Output Voltage	No input, DC measurement	VC	0.00	0.10	0.30	V_{DC}
		-60 dBm non-modulated input, DC measurement	VC	0.30	0.45	0.60	V_{DC}
		-30 dBm non-modulated input, DC measurement	VC	0.70	0.95	1.20	V_{DC}
		0 dBm non-modulated input, DC measurement	VC	1.05	1.35	1.65	V_{DC}
V_{OAM}	AM Demodulating Output Voltage	fm = 2 MHz (sine wave), modulation = 80%, -40 dBm input	VB	140	230	360	mV _{P-P}
V_{DAM}	AM Demodulating Output Voltage Deflection	-60 ~ -15 dBm input, fm = 2 MHz (sine wave), modulation = 80%	VB		±1.5	±3	dB
f_{DB2}	Demodulating Frequency Band	-6 dB point, modulation = 80%, Standard measured value at 100 kHz.	VB	2	3		MHz
RSSI COMPARATOR							
T_{R1}	Rise Time	IF no input, Pin 19 Input = $1 V_{DC}$, Pin 20 Input = 100 kHz, $0.1 V_{P-P}$, Square Wave (Duty Ratio = 50%, $T_R, T_F < 10\text{ ns}$), DC Offset = $1 V_{DC}$	VD		25	50	ns
T_{F1}	Fall Time		VD		15	30	ns
t_{PD1}	Propagation Delay Time (Low to High)		VD		55	110	ns
t_{PD2}	Propagation Delay Time (High to Low)		VD		55	110	ns
D_{R1}	Duty Ratio		VD	45	50	55	%
I_{SINK1}	Output Sink Current	DC measurement, Output Saturation Voltage = 0.3 V	A2	3.5	5.0		mA
V_{OUTH1}	Output Voltage High Level	DC measurement	VD	2.70	2.95	3.00	V_{DC}

TK14551V

TK14551V ELECTRICAL CHARACTERISTICS

Test conditions: $V_{CC} = 3\text{ V}$, $T_A = 25\text{ }^\circ\text{C}$, unless otherwise specified.

SYMBOL	PARAMETER	TEST CONDITIONS	MEASUREMENT POINT (NOTE 2)	MIN	TYP	MAX	UNITS
RSSI COMPARATOR (CONT.)							
V_{OUTL1}	Output Voltage Low Level	DC measurement, Output Sink Current = 5 mA	VD	0.00	0.30	0.45	V_{DC}
DATA COMPARATOR							
t_{PD3}	Propagation Delay Time (Low to High)	Input: DC Offset = $1 V_{DC}$, 2 MHz, $0.2 V_{P-P}$, Square Wave (Duty Ratio = 50%, $T_R, T_F < 10\text{ ns}$)	VE		55	110	ns
t_{PD4}	Propagation Delay Time (High to Low)		VE		55	110	ns
T_{R2}	Rise Time	Input: DC Offset = $1 V_{DC}$, 2 MHz, $0.2 V_{P-P}$, Sine Wave	VE		25	50	ns
T_{F2}	Fall Time		VE		15	30	ns
D_{R2}	Duty Ratio		VE	45	50	55	%
I_{SINK2}	Output Sink Current	DC measurement, Output Saturation Voltage = 0.3 V	A3	3.5	5.0		mA
V_{OUTH2}	Output Voltage High Level	DC measurement	VE	2.70	2.95	3.00	V_{DC}
V_{OUTL2}	Output Voltage Low Level	DC measurement, Output Sink Current = 5 mA	VE	0.00	0.30	0.45	V_{DC}
RSSI BUFFER AMPLIFIER 2							
I_{OUT}	Output Current	DC measurement	A4		± 200		μA
Z_{OUT}	Output Impedance	DC measurement	VB		130		Ω

TEST CIRCUIT

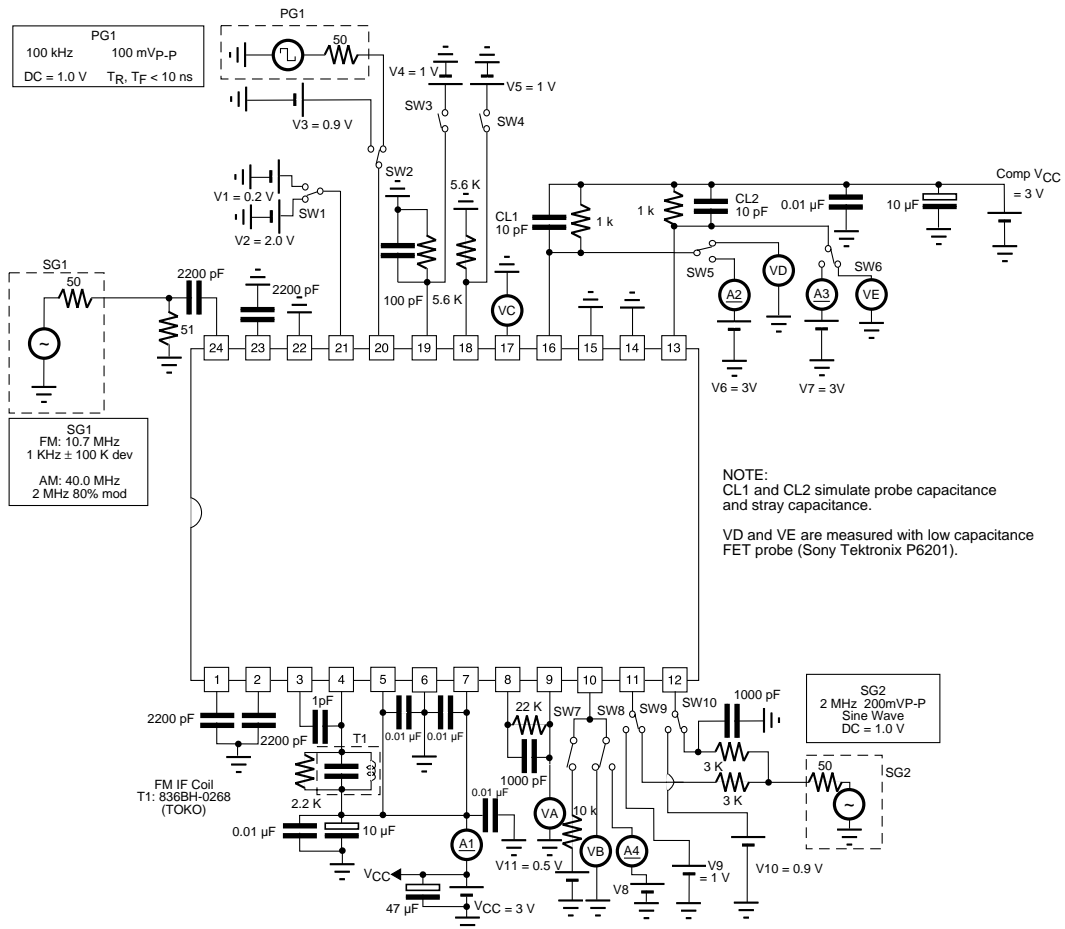

Example of 40 MHz (= f_{IN}) FM detection

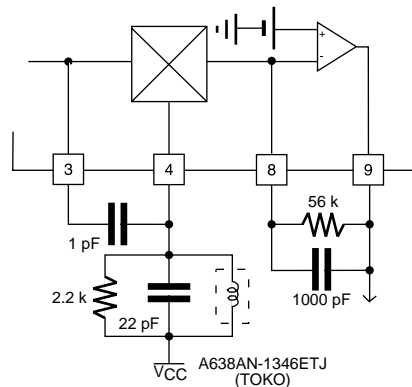

TEST CIRCUIT (CONT.)

Measurement of Battery Save Function:

Battery Save ON: SW1 = 0.2 V position
 Battery Save OFF: SW1 = 2 V position

Measurement of Comparator:

SW3 is closed only for the measurement of the RSSI comparator response characteristics and output sink current, supplying 1 V_{DC} to Pin 19.

PG1 is connected only for the measurement of the RSSI comparator response. Input the pulse wave to Pin 20, and measure the output wave (VD) of Pin 16.

I_{SINK1} (RSSI Comparator Output Current):

No IF input. SW2 = V3 position (supplying 0.9 V to Pin 20). SW3 = ON (supplying 1 V to Pin 19). SW5 = V6 position (supplying 3 V to Pin 16). Measure the DC current to Pin 16 from V6.

I_{SINK2} (Data Comparator Output Current):

SW9 = V9 position (supplying 1 V to Pin 11). SW10 = V10 position (supplying 0.9 V to Pin 12). SW6 = V7 position (supplying 3 V to Pin 13). Measure the DC current to Pin 13 from V7.

Measurement of T_R, T_F, t_{PD} (RSSI Comparator, Data Comparator):

RSSI Comparator: No IF input. SW2 = PG1 position. SW3 = ON (supplying 1 V to Pin 19). SW5 = VD position. Measure the output wave (VD).

Data Comparator: SW9 = 3 kΩ position. SW10 = 3 kΩ position. SW6 = VE position. Measure the output wave (VE).

T_R, T_F: Measure the time between the 10% point and the 90% point of the output wave.

t_{PD}: Measure the time between the 50% point of the input wave and the 50% point of the output wave.

Measurement of the Logarithmic Detection of RSSI Output:

SW7 = OFF. SW8 = VB position. Input AM modulation signal SG1 (f_{IN} = 40 MHz, f_m = 2 MHz, mod. = 80%, V_{IN} = -60, -40, -15 dBm) to Pin 24. Measure the logarithmic detection output voltage of Pin 10.

The AM demodulating output voltage deflection is standardizing the AM demodulating output voltage in the case of -40 dBm input, and calculated by the deflection by AM demodulating output voltage in the case of -60, -15 dBm input.

The measurement of demodulating frequency band is standardizing the AM demodulating output voltage of Pin 10 in the case that V_{IN} = -40 dBm, f_{IN} = 40 MHz, f_m = 100 kHz and 80% AM modulating output voltage at Pin 10, comparing it to the standard output voltage.

Measurement of Output Current of RSSI Buffer Amplifier 2:

SW7 = OFF. SW8 = V8 position. No IF input. SW4 = ON (supplying 1 V to Pin 18). Measure the DC current (A4) between V8 and Pin 10 in the case of V8 = 3 V, 0 V.

Measurement of Output Impedance of RSSI Buffer Amplifier 2:

No IF input. SW8 = VB position. SW4 = ON (supplying 1 V to Pin 18). At first, SW7 = OFF and measure the DC current (VB1) of Pin 10. Next, SW7 = ON and measure the DC current (VB2) of Pin 10. The output impedance (Z_{OUT}) is calculated by the following:

$$Z_{OUT} (\Omega) = 10 \text{ k} \cdot ((VB1 - VB2)/(VB2 - 0.5))$$

PIN FUNCTION DESCRIPTION

PIN NO.	SYMBOL	TERMINAL VOLTAGE	INTERNAL EQUIVALENT CIRCUIT	DESCRIPTION
1	IF DECOUPLE	1.8 V		Pin 1,2: The terminal to connect the bypass capacitor of the IF limiter amplifier.
2	IF DECOUPLE	1.8 V		Pin 23: IF Limiter Amplifier Non-inverting Input.
23	IF INPUT (+)	1.8 V		Pin 24: IF Limiter Amplifier Inverting Input.
24	IF INPUT (-)	1.8 V		
3	IF OUTPUT	2.0 V		IF Limiter Amplifier Output.
4	IF DEMODULATOR INPUT	3.0 V		FM Detector Input. Connection for the phase shift circuit.
5	IF V _{CC}	3.0 V		Power supply terminal of IF limiter amplifier, RSSI buffer amplifier-2 and FM detector
6	GND	0 V		GND Terminal
7	V _{CC}	3.0 V		Power supply terminal of RSSI buffer amplifier-1, RSSI comparator, and data comparator

TK14551V

PIN FUNCTION DESCRIPTION (CONT.)

PIN NO.	SYMBOL	TERMINAL VOLTAGE	INTERNAL EQUIVALENT CIRCUIT	DESCRIPTION
8 9	FM DEMODULATOR AMP INPUT FM DEMODULATOR AMP OUTPUT	1.4 V 1.4 V		Pin 8: FM Detector Post Amplifier Input. Pin 9: FM Detector Post Amplifier Output.
10	RSSI BUFFERED OUTPUT-2			RSSI Buffer Amplifier-2 Output.
11 12	DATA COMP INPUT (-) DATA COMP INPUT (+)			Pin 11: Data Comparator Inverting Input. Pin 12: Data Comparator Non-inverting Input.
13 14	DATA COMP OUTPUT DATA COMP GND	0 V		Pin 13: Data Comparator Output. The output circuit is open collector. Pin 14: The terminal to terminate the data comparator output.

PIN FUNCTION DESCRIPTION (CONT.)

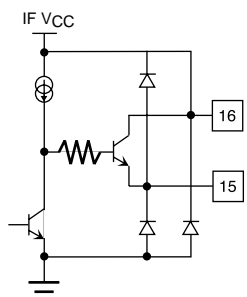
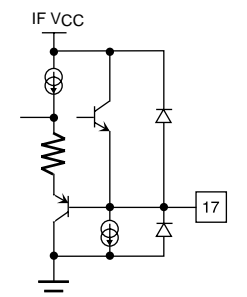
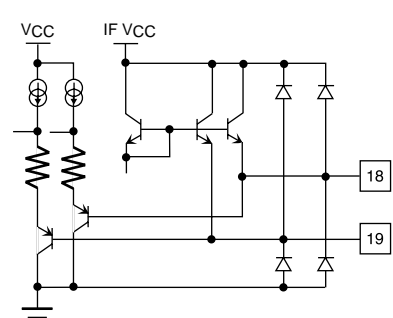
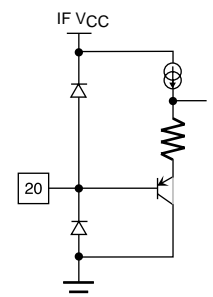
PIN NO.	SYMBOL	TERMINAL VOLTAGE	INTERNAL EQUIVALENT CIRCUIT	DESCRIPTION
15	RSSI COMP GND	0 V		<p>Pin 15: The terminal to terminate the RSSI comparator output.</p> <p>Pin 16: RSSI Comparator Output. The output circuit is open collector.</p>
16	RSSI COMP OUTPUT			
17	RSSI BUFFERED OUTPUT-1			RSSI Buffer Amplifier-1 Output.
18	RSSI OUTPUT-2			<p>Pin 18, 19: RSSI Output. These terminals are current outputs, converted to a voltage by connecting the external resistor between the output terminals and GND.</p>
19	RSSI OUTPUT-1			
20	RSSI COMP BIAS			RSSI Comparator Non-inverting Input. Supply the reference voltage.

TK14551V

PIN FUNCTION DESCRIPTION (CONT.)

PIN NO.	SYMBOL	TERMINAL VOLTAGE	INTERNAL EQUIVALENT CIRCUIT	DESCRIPTION
21	BATTERY SAVE	V_{BS}		<p>Battery Save Control.</p> <p>Battery Save OFF: $V_{BS} = 1.5 \text{ V to } V_{CC}$</p> <p>Battery Save ON: $V_{BS} < 0.3 \text{ V}$</p>
22	IF GND	0 V		GND Terminal

TYPICAL PERFORMANCE CHARACTERISTICS

$T_A = 25\text{ }^\circ\text{C}$, unless otherwise specified.

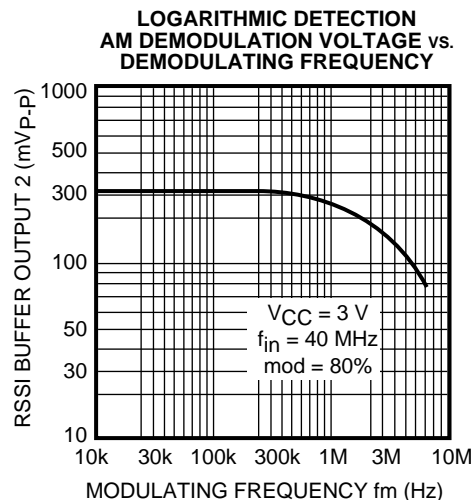
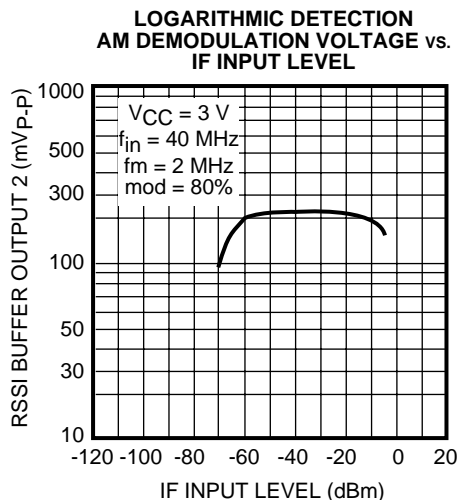
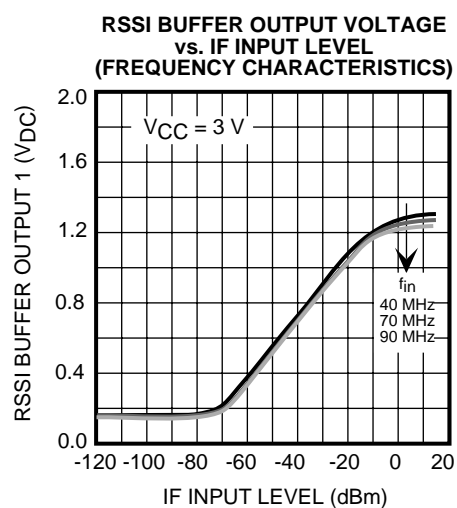
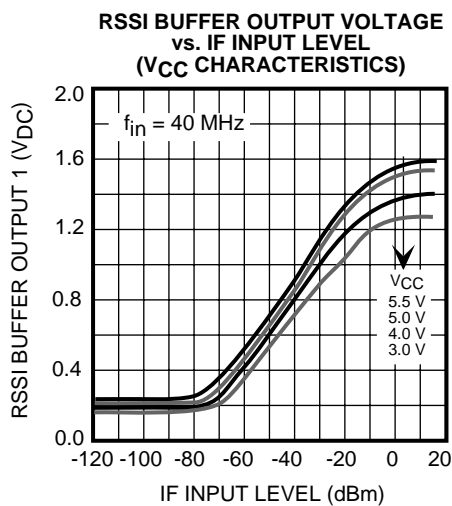
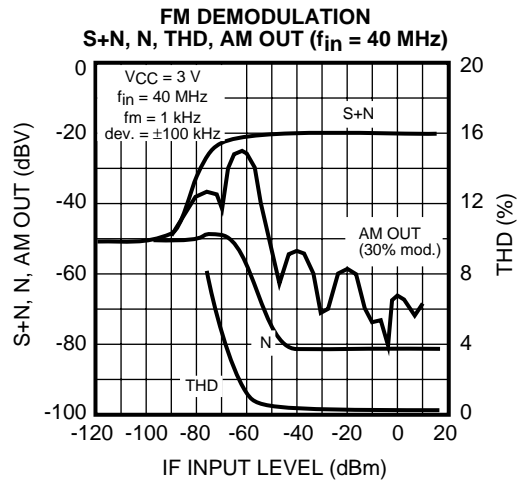
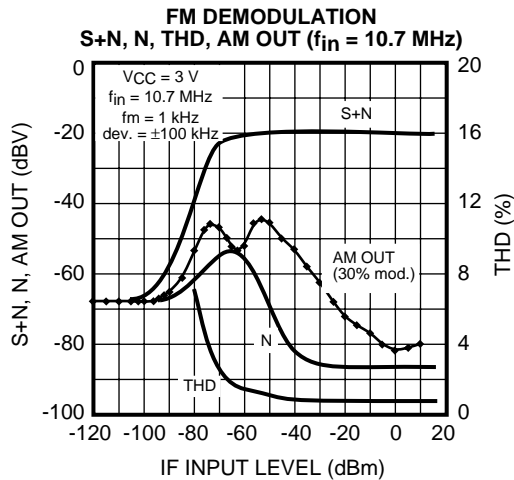

TYPICAL PERFORMANCE CHARACTERISTICS (CONT.)

$T_A = 25\text{ }^\circ\text{C}$, unless otherwise specified.

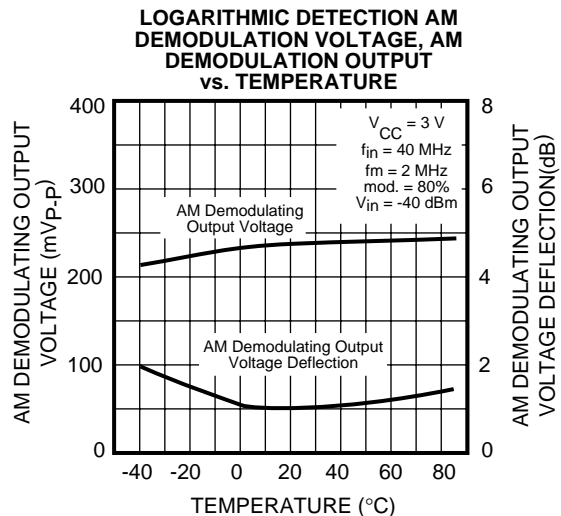
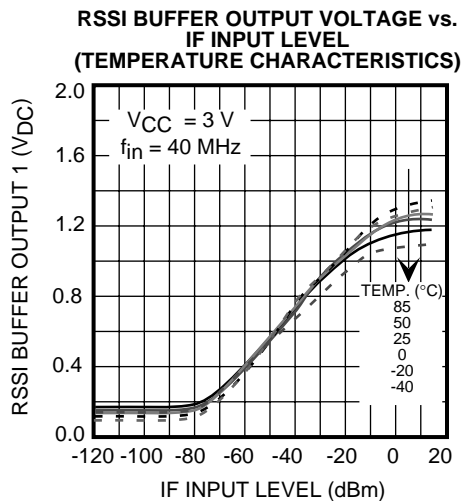
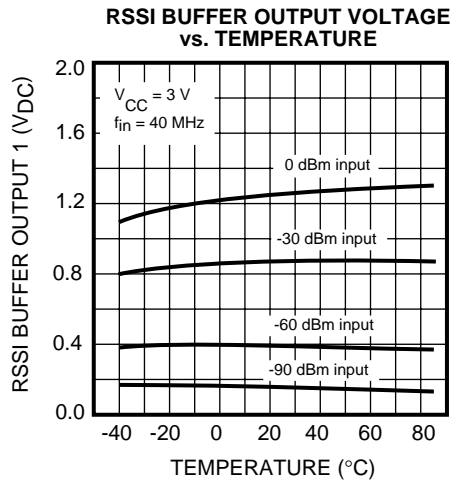
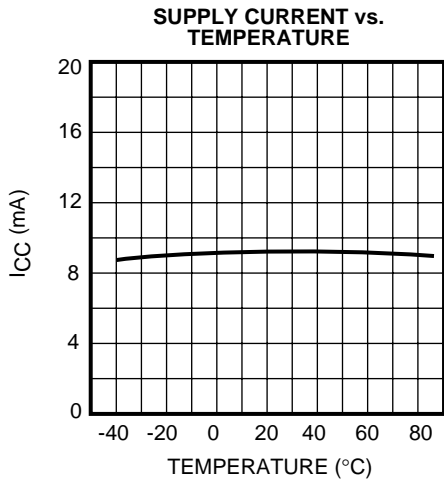
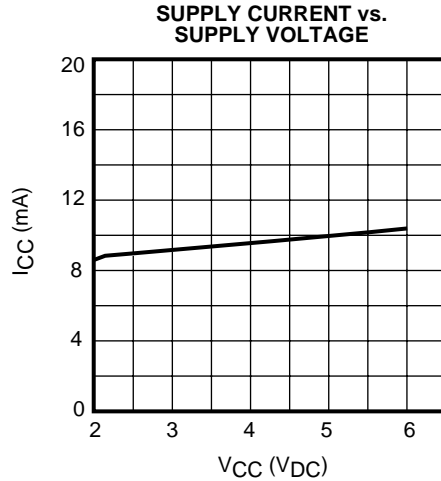
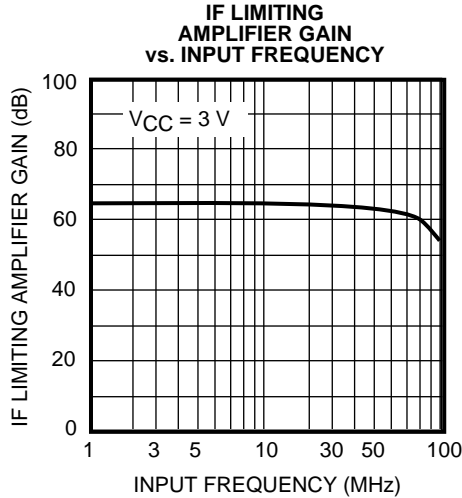

TYPICAL PERFORMANCE CHARACTERISTICS (CONT.)

$T_A = 25^\circ\text{C}$, unless otherwise specified.

**LOGARITHMIC DETECTION
AM DEMODULATION OUTPUT
vs. SUPPLY VOLTAGE**

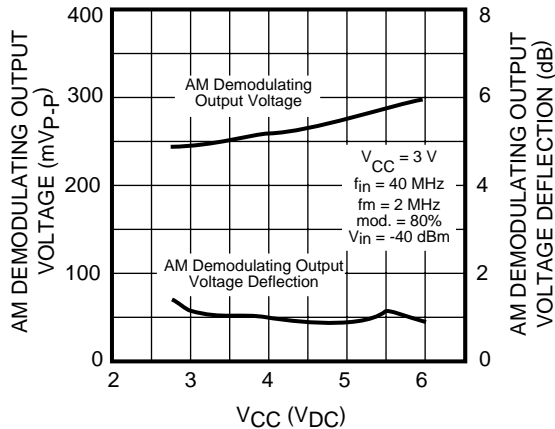

**FM DEMODULATION
DEMODULATION OUTPUT VOLTAGE,
TOTAL HARMONIC DISTORTION
vs. TEMPERATURE**

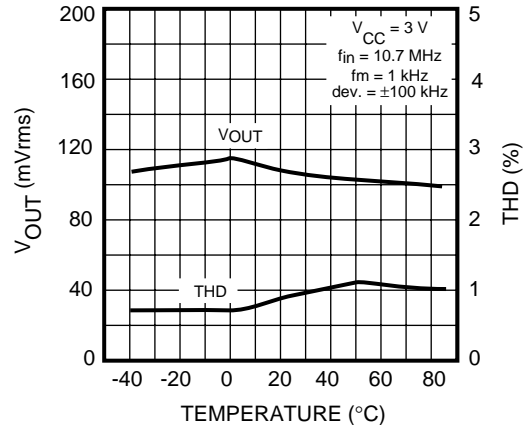

**FM DEMODULATION
S/N, -3 dB LIMITING SENSITIVITY
vs. TEMPERATURE**

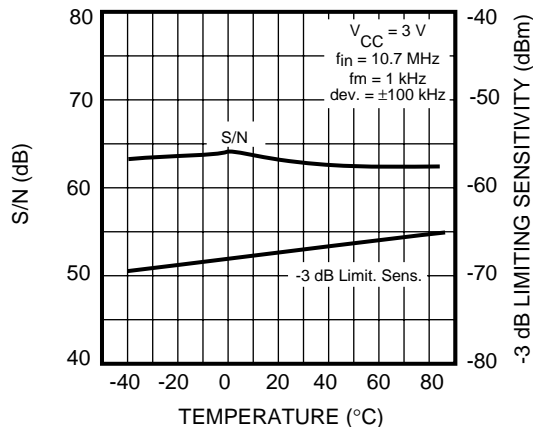

**FM DEMODULATION
DEMODULATION OUTPUT VOLTAGE,
TOTAL HARMONIC DISTORTION
vs. SUPPLY VOLTAGE**

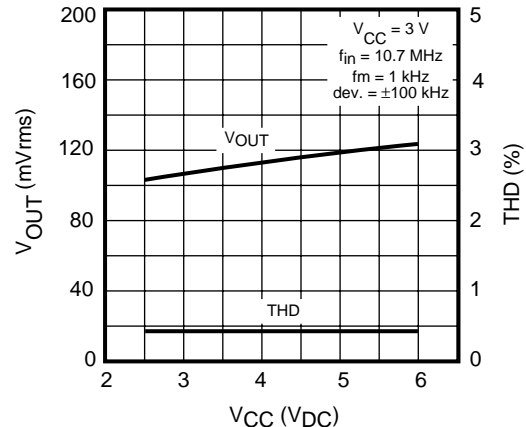

**FM DEMODULATION
S/N, -3 dB LIMITING SENSITIVITY
vs. SUPPLY VOLTAGE**

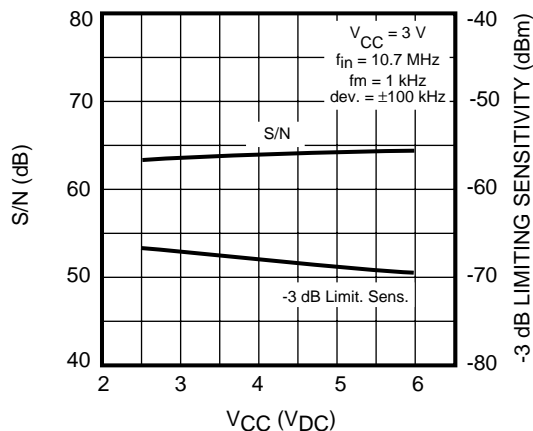

**DATA COMPARATOR
TRANSIENT RESPONSE
(RISE)**

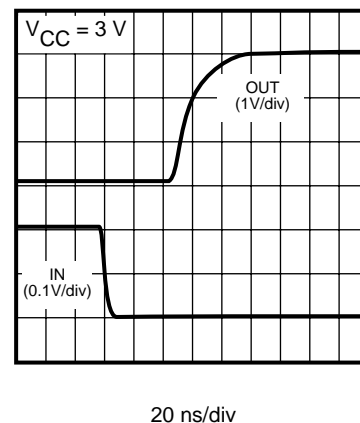

TYPICAL PERFORMANCE CHARACTERISTICS (CONT.)

$T_A = 25\text{ }^\circ\text{C}$, unless otherwise specified.

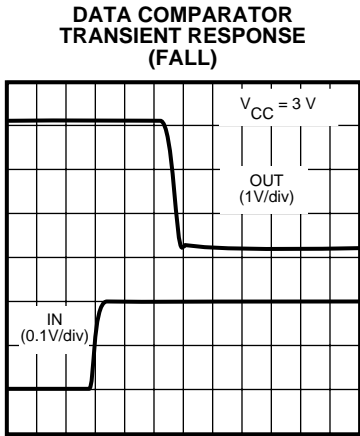

20 ns/div

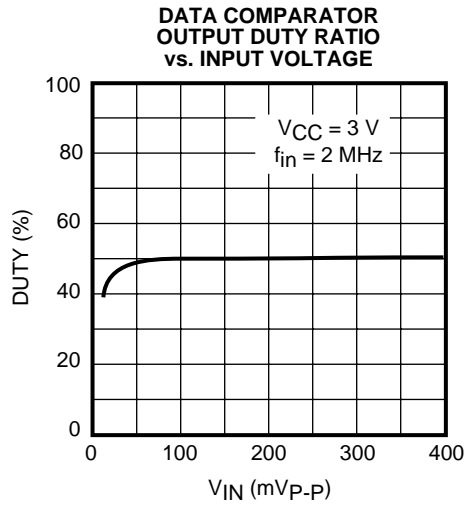

FM DEMODULATION FREQUENCY CHARACTERISTICS

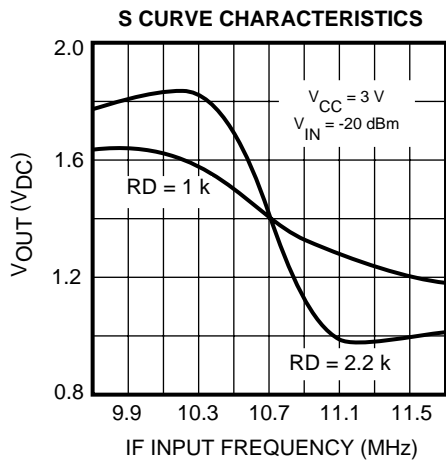
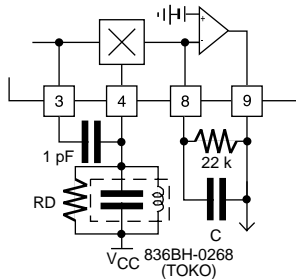

DEMODULATION OUTPUT VOLTAGE vs. DEMODULATING FREQUENCY
RD = 2.2 k Ω

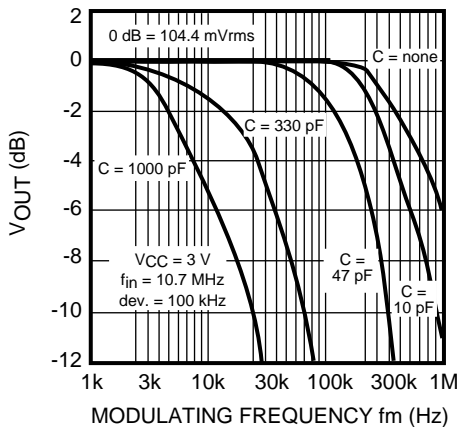

DEMODULATION OUTPUT VOLTAGE vs. DEMODULATING FREQUENCY
RD = 1.0 k Ω

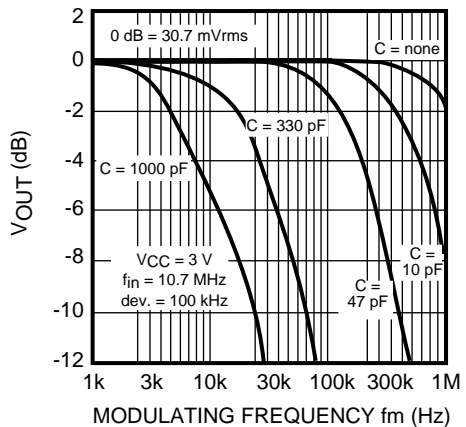

TYPICAL PERFORMANCE CHARACTERISTICS (CONT.)

$T_A = 25\text{ }^\circ\text{C}$, unless otherwise specified.

ASK Demodulation Output Wave, Effect of Inserting Active Filter

Condition: $V_{CC} = 3\text{ V}$, $f_{in} = 40\text{ MHz}$, $f_m = 2\text{ MHz}$ (sine wave), mod. = 80%, $V_{IN} = -40\text{ dBm}$

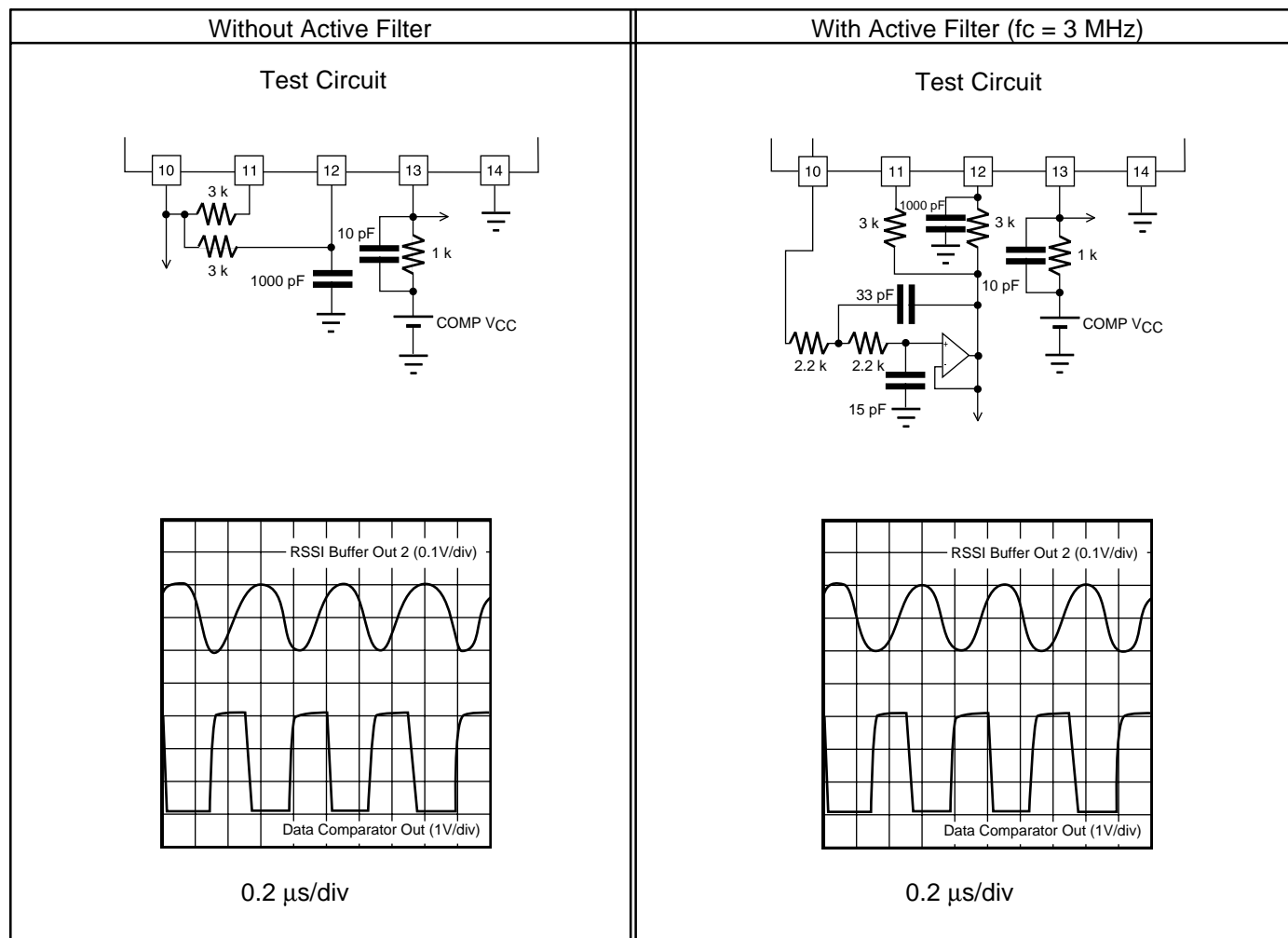

TYPICAL PERFORMANCE CHARACTERISTICS (CONT.)

$T_A = 25\text{ }^\circ\text{C}$, unless otherwise specified.

RSSI Buffer Output (Pin 17) Transient Response (IF Input ON/OFF)

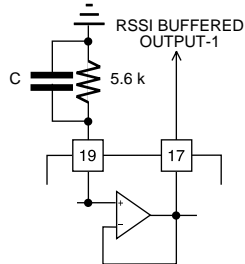

Condition
 $V_{CC} = 3\text{ V}$
 $f_{in} = 40\text{ MHz}$

• $C = 100\text{ pF}$

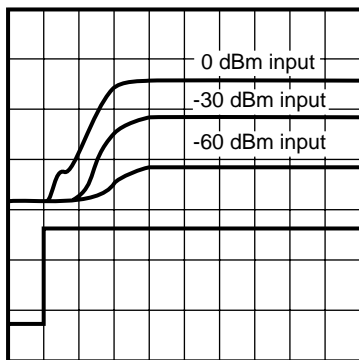

RSSI BUFFERED OUTPUT-1
 (0.5V/div)

SG GATE PULSE
 (1V/div)

2 $\mu\text{s/div}$

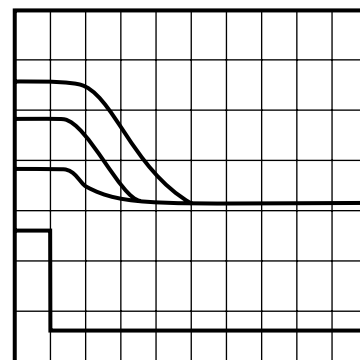

2 $\mu\text{s/div}$

• $C = 1000\text{ pF}$

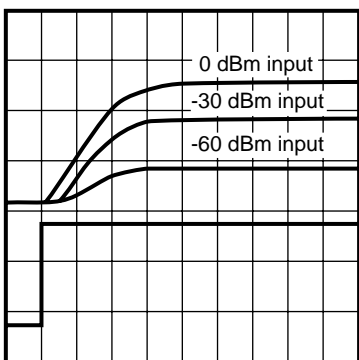

RSSI BUFFERED OUTPUT-1
 (0.5V/div)

SG GATE PULSE
 (1V/div)

5 $\mu\text{s/div}$

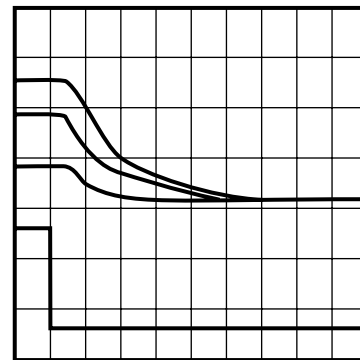

5 $\mu\text{s/div}$

• $C = 0.01\text{ }\mu\text{F}$

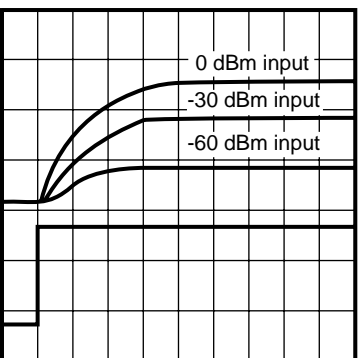

RSSI BUFFERED OUTPUT-1
 (0.5V/div)

SG GATE PULSE
 (1V/div)

50 $\mu\text{s/div}$

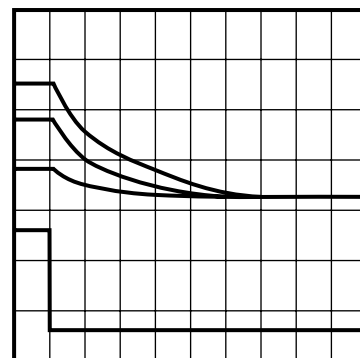

50 $\mu\text{s/div}$

TYPICAL PERFORMANCE CHARACTERISTICS (CONT.)

$T_A = 25\text{ }^\circ\text{C}$, unless otherwise specified.

RSSI Buffer Output-1 (Pin 17) Transient Response (Battery Save ON→OFF)

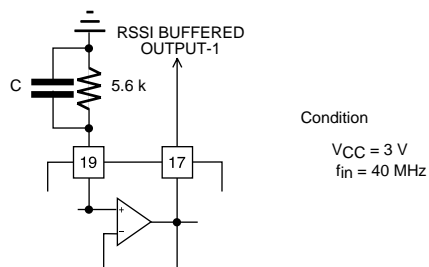

- $C = 100\text{ pF}$

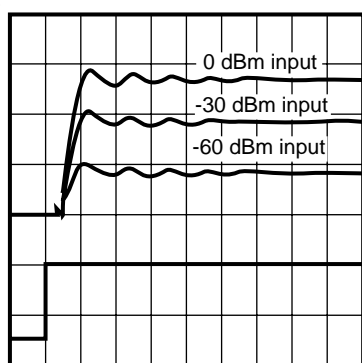

RSSI BUFFERED OUTPUT-1
(0.5V/div)

Battery Save
(1V/div)

2 $\mu\text{s/div}$

- $C = 1000\text{ pF}$

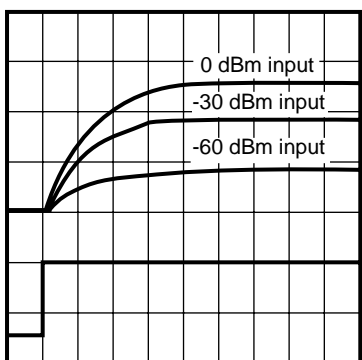

RSSI BUFFERED OUTPUT-1
(0.5V/div)

Battery Save
(1V/div)

5 $\mu\text{s/div}$

- $C = 0.01\text{ }\mu\text{F}$

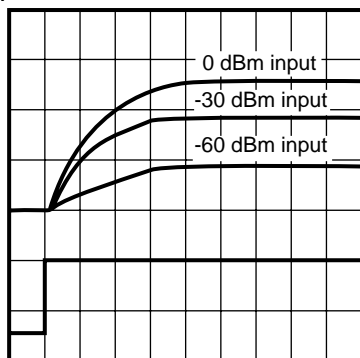

RSSI BUFFERED OUTPUT-1
(0.5V/div)

Battery Save
(1V/div)

50 $\mu\text{s/div}$

APPLICATION NOTES

If the input is FM or FSK modulation, whether the IF input is a balanced or an unbalanced input, there is no problem. But, if the input is ASK modulation and the IF input is a balanced input, the Bit Error Rate (BER) may be high. Therefore, if the input is ASK modulation, the IF input must be an unbalanced input. If the input is an unbalanced input as shown below, do not terminate Pin 1 (do not connect the bypass capacitor between Pin 1 and GND). If Pin 23 is the input do not terminate Pin 2.

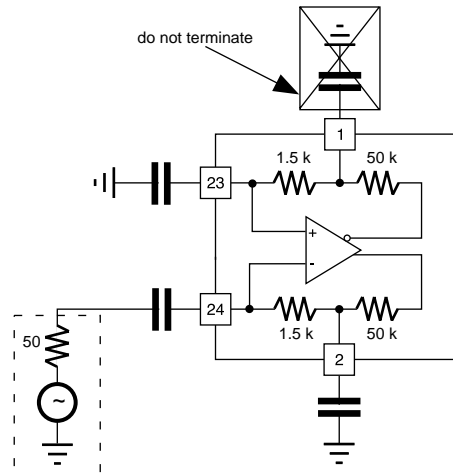

CIRCUIT DESCRIPTION

IF Limiter Amplifier:

The IF limiter amplifier is composed of four differential gain stages. The total gain of the IF limiter amplifier is about 64 dB. The output signal of the IF limiter amplifier is provided at Pin 3 through the emitter-follower output stage. The IF limiter amplifier output level is $0.5 V_{P-P}$.

The operating current of the IF limiter amplifier emitter-follower output is $550 \mu\text{A}$. If the capacitive load is heavy, the negative half cycle of the output waveform may be distorted. This distortion can be reduced by connecting an external resistor between Pin 3 and GND to increase the operating current. The increased operating current by using an external resistor is calculated as follows (see Figure 1):

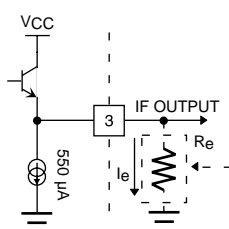

FIGURE 1

The increased operating current I_e (mA) = $(V_{CC} - 1.0)/R_e$ (k Ω).

Because the IF input is a balanced input, it is easy to match a SAW filter, etc.

If the IF input is an unbalanced input, connect Pin 23 or 24 with a bypass capacitor to ground.

The input resistance of the IF limiter amplifier is 1.5 k Ω (see Figure 2). If the impedance of the filter is lower than 1.5 k Ω , connect an external resistor between Pin 24 and Pin 2 or between Pin 23 and Pin 1 in parallel to provide the equivalent load impedance of the filter. Figure 2 shows an example of a filter with a 330 Ω impedance.

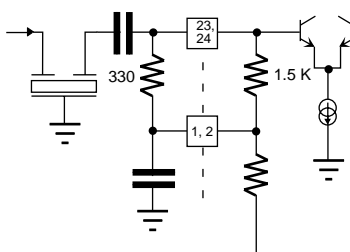
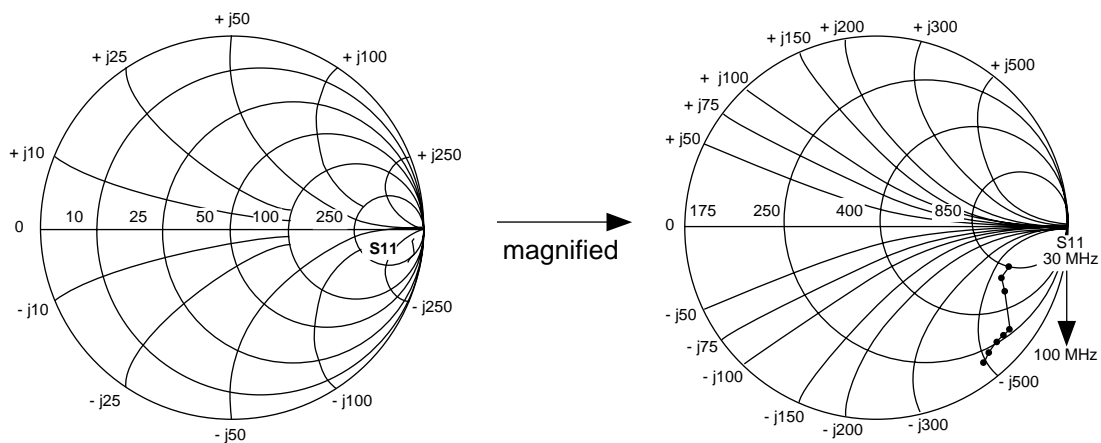

FIGURE 2

CIRCUIT DESCRIPTION

The input impedance of the IF limiter amplifier (between Pin 23, 24 and GND) is as follows:

FREQUENCY (MHz)	S11		$Z_{in} [\Omega]$ (series impedance)
	S11	$\angle \phi$	
30	0.932	-3.4	831-j701
40	0.928	-4.2	683-j667
50	0.930	-5.2	538-j672
60	0.939	-7.6	294-j613
70	0.933	-8.0	285-j574
80	0.926	-8.3	287-j537
90	0.920	-9.2	255-j490
100	0.916	-10.0	230-j450



CIRCUIT DESCRIPTION

RSSI, RSSI Buffer Amplifier:

Because the RSSI output of this product is a dual output, it has various uses. Because it includes a dual high-speed RSSI output, it is possible to sense the carrier level and to demodulate AM at the same time.

The RSSI output is a current output. It converts to a voltage by an external resistor between Pin 28,19 and GND. The time constant of the RSSI output is determined by the product of the external converting resistor and parallel capacitor. When the time constant is longer, the RSSI output is more immune to disturbances or the component of amplitude modulation, but the RSSI output response is lower. Determine the external resistor and capacitor with this in mind.

It is possible to modify the slope of the RSSI curve characteristic by changing the external resistor. In this case, the maximum range of converted RSSI output voltage is GND level to about $V_{CC} - 0.2\text{ V}$ (the supply voltage minus the collector saturation voltage of the output transistor).

In addition, it is possible to modify the temperature characteristic of the RSSI output voltage by changing the temperature characteristic of the external resistor. Normally, the temperature characteristic of the RSSI output voltage is very stable when using a carbon resistor or metal film resistor with a temperature characteristic of 0 to 200 ppm/°C.

This product is very accurate, because the RSSI characteristic is trimmed individually.

Both systems of RSSI output are connected to individual buffer amplifiers with an internal gain of 1. Therefore, even if the load impedance is heavy, it is possible to take out the RSSI output signal from the buffer amplifier output. The maximum input and output level of this buffer amplifier is $V_{CC} - 1.0\text{ V}$.

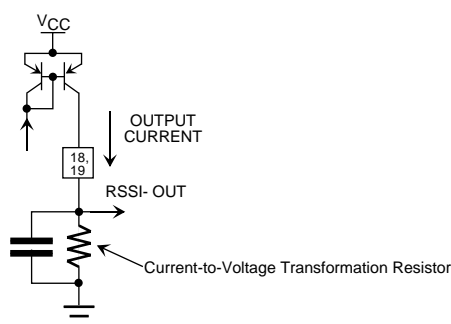

FIGURE 3 - RSSI OUTPUT STAGE

AM Demodulation by Using the RSSI Output:

Although the distortion of the RSSI output is high because it is a logarithmic detection of the envelope to the IF input, AM can be demodulated simply by using the RSSI output. In this case, the input dynamic range that can demodulate AM is the inside of the linear portion of the RSSI curve characteristic (see Figure 4).

This method does not have a feedback loop to control the gain because an AGC amplifier is not necessary (unlike the popularly used AM demodulation method). Therefore, it is a very useful application for some uses because it doesn't have the response time problem.

CIRCUIT DESCRIPTION

Figure 4 shows the AM demodulated waveform.

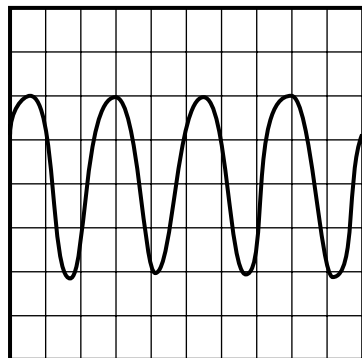

Operating Condition:
 $V_{CC} = 3\text{ V}$, $f_{in} = 40\text{ MHz}$,
 $f_m = 2\text{ MHz}$, $\text{Mod} = \pm 80\%$,
 $V_{IN} = -40\text{ dBm}$

50 mV/div
 0.2 $\mu\text{s}/\text{div}$

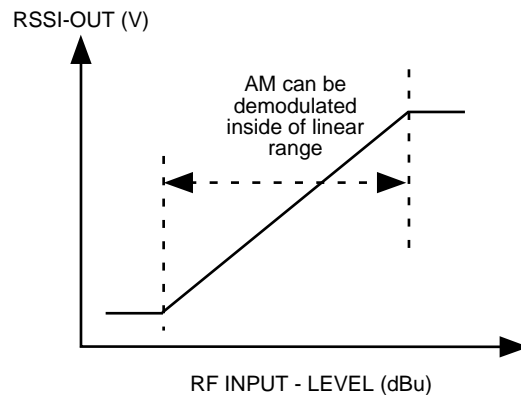
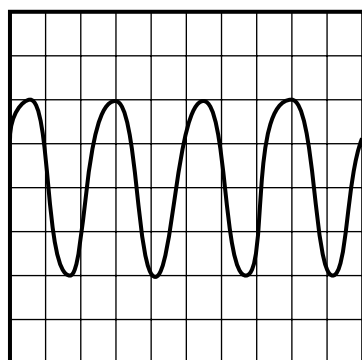

FIGURE 4 -AM DEMODULATED WAVEFORM

If it is necessary to improve the distortion of the AM demodulated waveform of logarithmic detection, connect a low pass filter to the RSSI buffer amplifier output. Figure 5 shows the AM demodulated waveform with a low pass filter inserted.



Operating Condition:
 $V_{CC} = 3\text{ V}$, $f_{in} = 40\text{ MHz}$,
 $f_m = 2\text{ MHz}$, $\text{Mod} = \pm 80\%$,
 $V_{IN} = -40\text{ dBm}$

50 mV/div
 0.2 $\mu\text{s}/\text{div}$

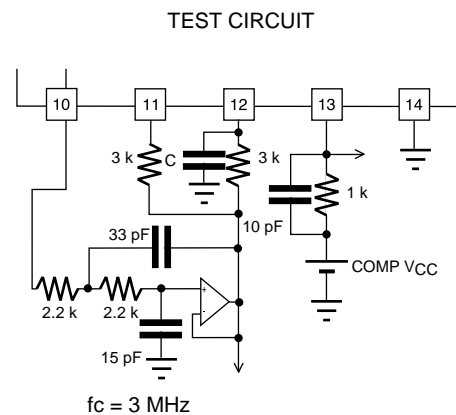

FIGURE 5

CIRCUIT DESCRIPTION

FM Detector:

The FM detector is included in the quadrature FM detector using a Gilbert multiplier.

It is suitable for high speed data communication because the demodulation bandwidth is over 1 MHz.

The phase shifter is connected between Pin 3 (IF limiter output) and Pin 4 (input detector). Any available phase shifter can be used: a LC resonance circuit, a ceramic discriminator, a delay line, etc.

Figure 6 shows the internal equivalent circuit of the detector.

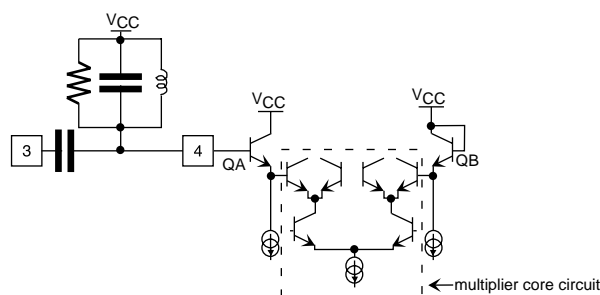

FIGURE 6 - DETECTOR INTERNAL EQUIVALENT CIRCUIT

The signal from the phase shifter is applied to the multiplier (in the dotted line) through emitter-follower stage QA. When the phase shifter is connected between pin 3 and pin 4, note that the bias voltage to pin 4 should be provided from an external source because pin 4 is only connected to the base of QA.

Because the base of QB (at the opposite side) is connected with the supply voltage, Pin 4 has to be biased with the equivalent voltage.

Using an LC resonance circuit is not a problem (see Figure 7). However, when using a ceramic discriminator, it is necessary to pay attention to bias. If there is a difference of the base voltages, the DC voltages of the multiplier do not balance. It alters the DC zero point or worsens the distortion of demodulation output.

The Pin 4 input level should be saturated at the multiplier; if this level is lower, it is easy to disperse the modulation output. Therefore, to have stable operation, Pin 4 should be higher than $100 \text{ mV}_{\text{P-P}}$.

The following figures show examples of the phase shifter.

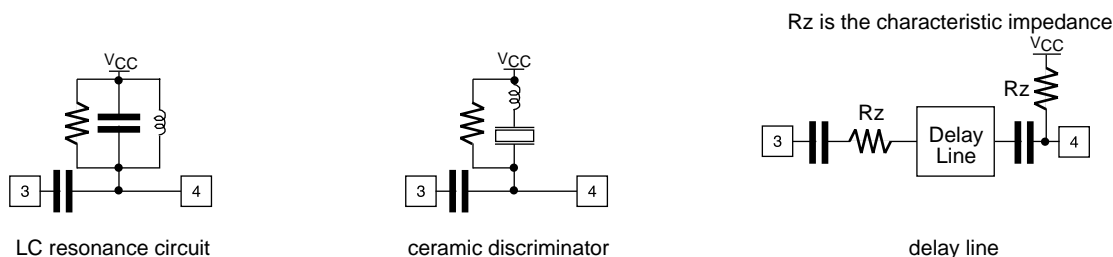

FIGURE 7 - EXAMPLES OF PHASE SHIFTERS

CIRCUIT DESCRIPTION

Establishing Demodulation Characteristics:

Generally, demodulation characteristics of FM detectors are determined by the external phase shifter. However, this product has a unique function which can optionally establish the demodulation characteristics by the time constant of the circuit parts after demodulation. The following explains this concept.

Figure 8 shows the internal equivalent circuit of the detector output stage.

The multiplier output current of the detector is converted to a voltage by the internal OP AMP. The characteristic of this stage is determined by converting the current to voltage with resistor R_0 and the capacitor C_0 connected between Pin 8 and Pin 9 (see Figure 8).

In other words, the slope of the S-curve characteristic can be established optionally with resistor R_0 without changing the constant of the phase shifter. The demodulated bandwidth can be established optionally by the time constant of this external resistor R_0 and capacitor C_0 inside of a bandwidth of the IF-filter and phase shifter. Figure 9 shows an example of this characteristic.

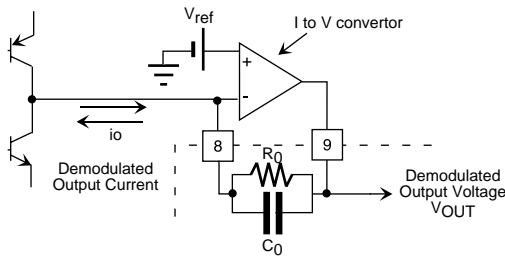

The -3 dB frequency F_c is calculated by the following:

$$F_c = \frac{1}{2 \pi C_0 R_0}$$

The S-curve output voltage is calculated by the following as centering around the internal reference voltage V_{ref} :

$$V_{OUT} = V_{ref} \pm i_o \times R_0$$

Where $V_{ref} = 1.4 \text{ V}$, maximum of current $i_o = \pm 100 \mu\text{A}$

FIGURE 8 - INTERNAL EQUIVALENT CIRCUIT OF DETECTOR OUTPUT STAGE

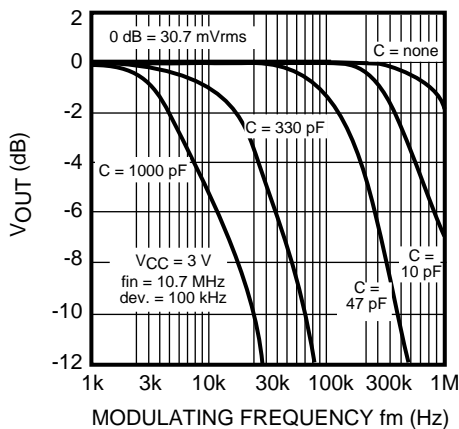

Operating Condition:

- Measured by the standard test circuit.
- Parallel resistor to phase shift coil = 1 kΩ.
- $f_{IN} = 10.7 \text{ MHz}$, modulation = $\pm 100 \text{ kHz}$.
- External capacitance $C_0 = 0 \sim 1000 \text{ pF}$.

FIGURE 9 - EXAMPLE: BAND WIDTH OF DEMODULATION VS. TIME CONSTANT CHARACTERISTIC

CIRCUIT DESCRIPTION

Center Voltage of Detector DC Output:

The center voltage of the detector DC output is determined by the internal reference voltage source. It is impossible to change this internal reference voltage source, but it is possible to change the center voltage by the following method.

As illustrated in Figure 10, the demodulated output current at Pin 8 is converted to the voltage by an external resistor R1, without using the internal OP AMP.

Figure 11 shows an example of a simple circuit that divides the supply voltage into halves using resistors. Since both circuits have a high output impedance, an external buffer amplifier should be connected.

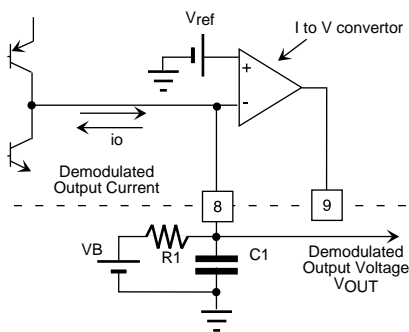

$$\text{Demodulated Output Voltage } V_{OUT} = V_B \pm R1 \times i_o$$

$$\text{Demodulated Bandwidth } F_c = \frac{1}{2 \pi C1(1/gm)}$$

1/gm is approximately 50 kΩ which is the output resistance of the multiplier.

Pin 9 is disconnected.

FIGURE 10 - EXAMPLE OF USING EXTERNAL REFERENCE SOURCE

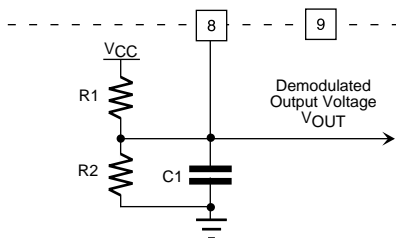

$$\text{Demodulated Output Voltage } V_{OUT} = V_{CC} / 2 \pm R1 \times i_o$$

$$\text{Demodulated Bandwidth } F_c = \frac{1}{2 \pi C1(1/gm)}$$

1/gm is approximately 50 kΩ, which is the output resistance of the multiplier.

Pin 9 is disconnected.

FIGURE 11 - EXAMPLE OF DIVIDING SUPPLY VOLTAGE INTO HALVES BY RESISTORS

TK14551V

CIRCUIT DESCRIPTION

RSSI Comparator, Data Comparator:

The TK14551V contains a general purpose high speed data comparator and RSSI comparator for the base band processing.

Because the input stage is composed of PNP transistors, it is possible to operate from a minimum voltage of 0.1 V to the supply voltage - 1.0 V (see Figure 12).

Moreover, since the HFE of this PNP transistor is over 100, the bias current is below 0.01 μA (this is below the value of the competitors products which typically use a lateral PNP transistor at the input stage).

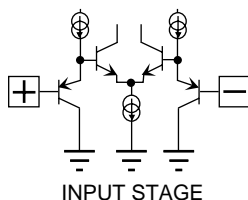

FIGURE 12 - COMPARATOR INPUT STAGE

Figure 13 shows the internal equivalent circuit of the comparator output stage. Because the comparator output is an open collector, it is suitable for many interface levels. This open collector output is connected with an electrostatic discharge protection diode at the GND side only; it is not connected with it at the power supply side in consideration of operating the voltage over the supply voltage of this IC.

When the collector pull-up resistor value is low, high operating currents result. To prevent interference to the other circuitry, the emitters of the output transistors are brought out independently at Pins 14 and 15.

Pins 14 and 15 are not connected with the substrate and other GNDs internal to the IC. Therefore, when operating these comparators, these terminals must be connected to GND.

When these comparators are operating at high speed, the etch pattern of Pins 13, 14, 15, and 16 (comparator output stages) should not be run close to the etch pattern of Pins 23 and 24 (IF inputs). The switching waveforms of the comparator outputs may have an effect on the IF inputs and may add noise to the zero crossing of the demodulated waveform, resulting in cross over distortion.

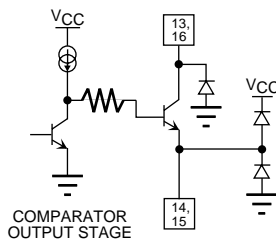

FIGURE 13 - COMPARATOR OUTPUT STAGE

Because the negative input of the RSSI comparator is connected to the RSSI buffer amplifier output-1 internally, it is used for carrier sensing.

The data comparator is used for the data shaper.

CIRCUIT DESCRIPTION

Battery Save Function:

Pin 21 is the control terminal for the battery save function. The ON/OFF operation of the whole IC can be switched by controlling the DC voltage at this terminal. Figure 14 shows the internal equivalent circuit of Pin 21.

Because it switches the bias circuit of the whole IC using the transistor in standby mode, it reduces the supply current to near zero. As the input terminal is connected with an electrostatic discharge protection diode at GND side only, it is possible to control the voltage above the supply voltage. It is possible to go into standby mode by disconnecting Pin 21, but it is not recommended because Pin 21 is a high impedance and may malfunction from an external disturbance.

When Pin 21 is disconnected, a suitable capacitor should be connected between Pin 21 and GND.

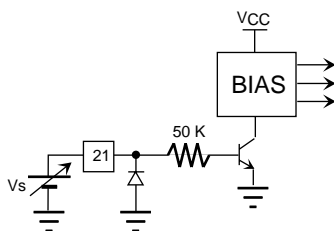

FIGURE 14 - BATTERY SAVE

Application of ASK(Amplitude Shift Keying) Demodulation:

Figure 15 shows an example application of ASK demodulation.

If the application circuit is like Figure 15, the transient response time is long because of the time constant of the rectifier (Pin 12) of the data comparator input.

On the other hand, if the circuit construction between the RSSI buffer amplifier output-2 (Pin 10) and the data comparator input is Figure 16, the transient response time is shortened. Since the demodulation is a logarithmic detection using the RSSI output, the demodulated wave of the RSSI buffer amplifier output-2 is distorted making the duty ratio of the data comparator output worse. The output duty ratio may be improved by adding the offset DC voltage (V_s) to the DC voltage of Pin 11 of the data comparator input. V_s is established at a few tens of mV. But, as the demodulation level of the RSSI buffer amplifier output-2 is changed by the dispersion, it is best to control V_s by a variable resistor, etc. It is possible to substitute the variable resistor for V_s .

TEST BOARD

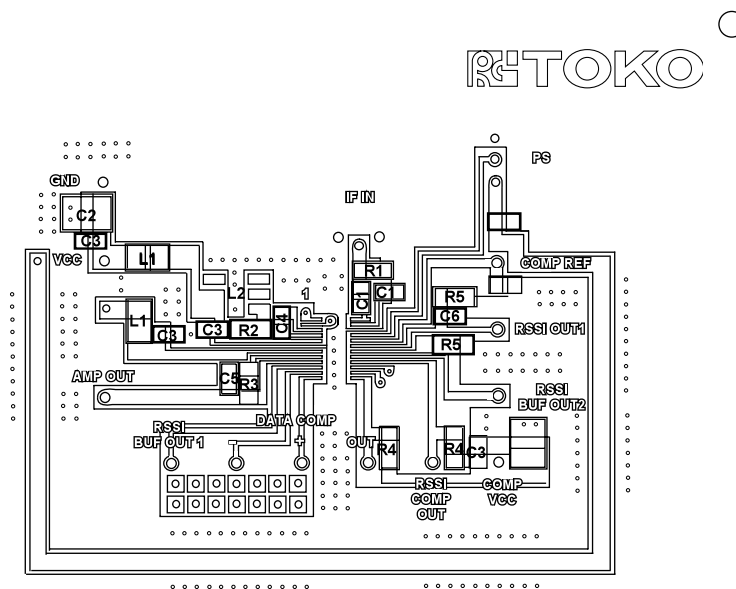

AP-353

TK14551V

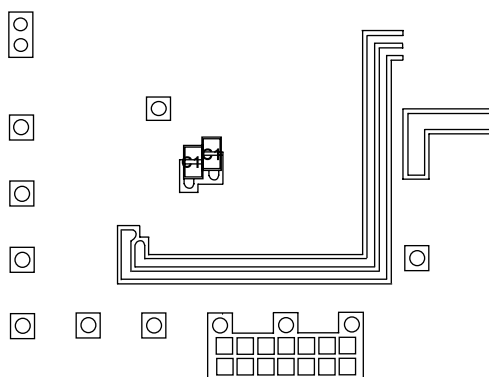

$C1 = 2200 \text{ pF}$, $C2 = 10 \text{ } \mu\text{F}$, $C3 = 0.01 \text{ } \mu\text{F}$, $C4 = 1 \text{ pF}$, $C5 = 1000 \text{ pF}$, $C6 = 100 \text{ pF}$
 $R1 = 50 \text{ } \Omega$, $R2 = 2.2 \text{ k}\Omega$, $R3 = 22 \text{ k}\Omega$, $R4 = 1 \text{ k}\Omega$, $R5 = 5.6 \text{ k}\Omega$
 $L1 = 10 \text{ } \mu\text{H}$, $L2 = 836\text{BH-0268 (TOKO)}$

NOTES

NOTES

PACKAGE OUTLINE

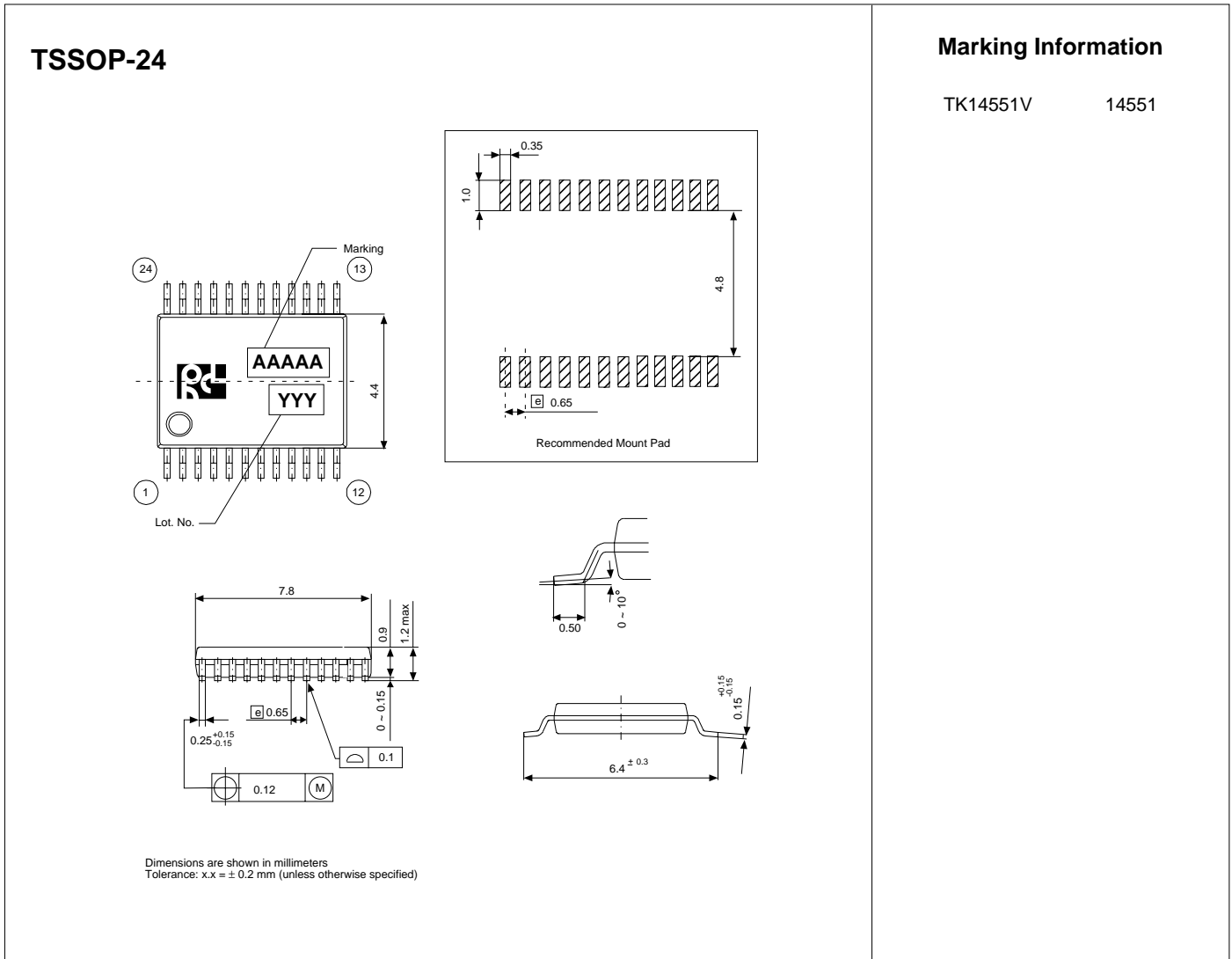

Toko America, Inc. Headquarters
 1250 Feehanville Drive, Mount Prospect, Illinois 60056
 Tel: (847) 297-0070 Fax: (847) 699-7864

TOKO AMERICA REGIONAL OFFICES

Midwest Regional Office
 Toko America, Inc.
 1250 Feehanville Drive
 Mount Prospect, IL 60056
 Tel: (847) 297-0070
 Fax: (847) 699-7864

Western Regional Office
 Toko America, Inc.
 2480 North First Street, Suite 260
 San Jose, CA 95131
 Tel: (408) 432-8281
 Fax: (408) 943-9790

Eastern Regional Office
 Toko America, Inc.
 107 Mill Plain Road
 Danbury, CT 06811
 Tel: (203) 748-6871
 Fax: (203) 797-1223

Semiconductor Technical Support
 Toko Design Center
 4755 Forge Road
 Colorado Springs, CO 80907
 Tel: (719) 528-2200
 Fax: (719) 528-2375

Visit our Internet site at <http://www.tokoam.com>

The information furnished by TOKO, Inc. is believed to be accurate and reliable. However, TOKO reserves the right to make changes or improvements in the design, specification or manufacture of its products without further notice. TOKO does not assume any liability arising from the application or use of any product or circuit described herein, nor for any infringements of patents or other rights of third parties which may result from the use of its products. No license is granted by implication or otherwise under any patent or patent rights of TOKO, Inc.