

FEATURES

- 0...4 "H₂O to 0...150 psi gage or differential, 0...15 to 0...150 psi absolute
- Precision temperature compensated
- Calibrated offset and span
- Voltage excitation
- Excellent long term stability

SERVICE

Non-corrosive, non-ionic working fluids such as clean dry air, dry gases and the like.

The media wetted materials are:

- port 1:
 - front side of silicon sensor chip
 - glass filled nylon
 - RTV
 - silgel (for devices of 5 psi and above)
 - ceramic (Al₂O₃)
- port 2:
 - silicon sensor chip
 - glass filled nylon
 - RTV
 - ceramic (Al₂O₃)

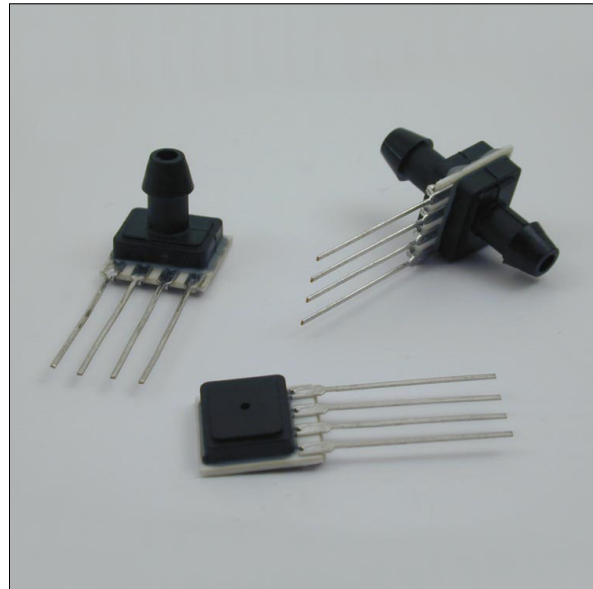

EQUIVALENT CIRCUIT

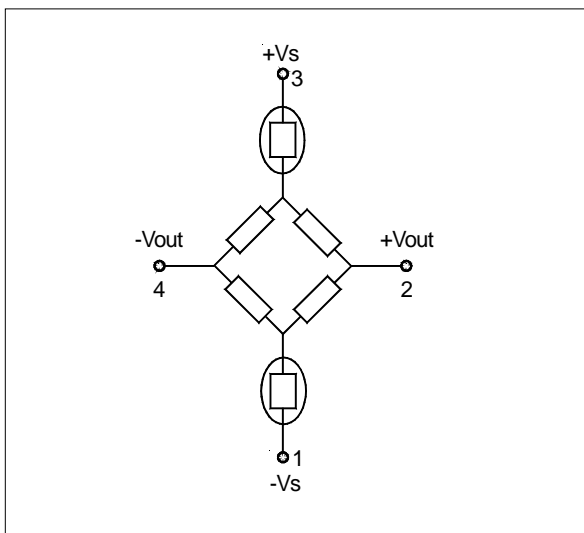

ELECTRICAL CONNECTION

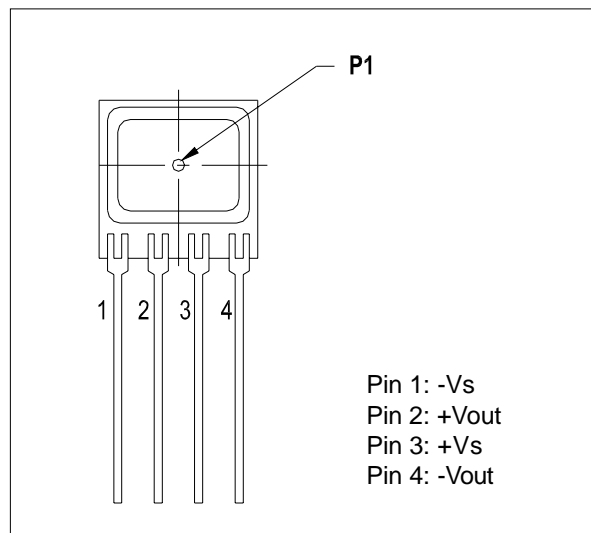

SPECIFICATIONS

Maximum ratings (for all devices)

Supply voltage V_s	3 to 16 V
Lead temperature (soldering 5 seconds)	315 °C
Common mode pressure	50 psig

Environmental specifications (for all devices)

Temperature range	
Compensated	0 to 70 °C
Operating	-25 to 85 °C
Storage	-40 to 125 °C
Humidity limits (non-condensing)	0 to 95 %RH

PRESSURE SENSOR CHARACTERISTICS

$V_s = 12\text{ V}$, $T_A = 25^\circ\text{C}$, pressure applied to port P1

Part no.	Operating pressure	Proof pressure ¹	Burst pressure ²	Full scale span ³		
				Min.	Typ.	Max.
CPCL04...	4 "H ₂ O	3 psi	5 psi	23 mV	25 mV	27 mV
CPCL10...	10 "H ₂ O	3 psi	5 psi	19 mV	20 mV	21 mV
CPC0.3...	0.3 psi	3 psi	5 psi	19 mV	20 mV	21 mV
CPC01...	1 psi	3 psi	5 psi	17 mV	18 mV	19 mV
CPC05...	5 psi	15 psi	25 psi	57 mV	60 mV	63 mV
CPC15...	15 psi	45 psi	75 psi	85 mV	90 mV	95 mV
CPC30...	30 psi	90 psi	150 psi	85 mV	90 mV	95 mV
CPC60...	60 psi	180 psi	300 psi	85 mV	90 mV	95 mV
CPC100...	100 psi	250 psi	400 psi	95 mV	100 mV	105 mV
CPC150...	150 psi	250 psi	400 psi	85 mV	90 mV	95 mV

PERFORMANCE CHARACTERISTICS

$V_S = 12\text{ V}$, $T_A = 25^\circ\text{C}$, pressure applied to port P1

Characteristics	Min.	Typ.	Max.	Unit
Zero pressure offset	-1.0	0	+1.0	mV
Combined non-linearity and hysteresis ⁴		±0.25	±1.0	%FSS
Temperature effects (0 to 70°C) ⁵	Span		±2.0	
	Offset		±1.0	mV
Input resistance	5			kΩ
Output resistance		3		
Response time (10 to 90 %FSS)	CPCL...		500	μs
	CPC...		100	
Common mode voltage ⁶		6		V

Notes

- ¹ Proof pressure is the maximum pressure which may be applied without causing durable shifts of the electrical parameters of the sensing element.
- ² Burst pressure is the maximum pressure which may be applied without causing damage to the sensing element or leaks from the housing.
- ³ Full scale span is the algebraic difference between the output voltage at full-scale pressure and the output at zero pressure. The span is ratiometric to the supply voltage.
- ⁴ Non-linearity refers to the **Best Straight Line** fit measured for offset pressure, full-scale pressure and ½ full-scale pressure.
- ⁵ Shift is relative to 25°C. The CPCL04... has a compensated temperature range from 0 to 50°C.
- ⁶ This is the common-mode voltage of the output arms (pins 2 and 4) for $V_S = 12\text{ V}$.

OUTLINE DRAWING

**Package version G and A
 (no port)**

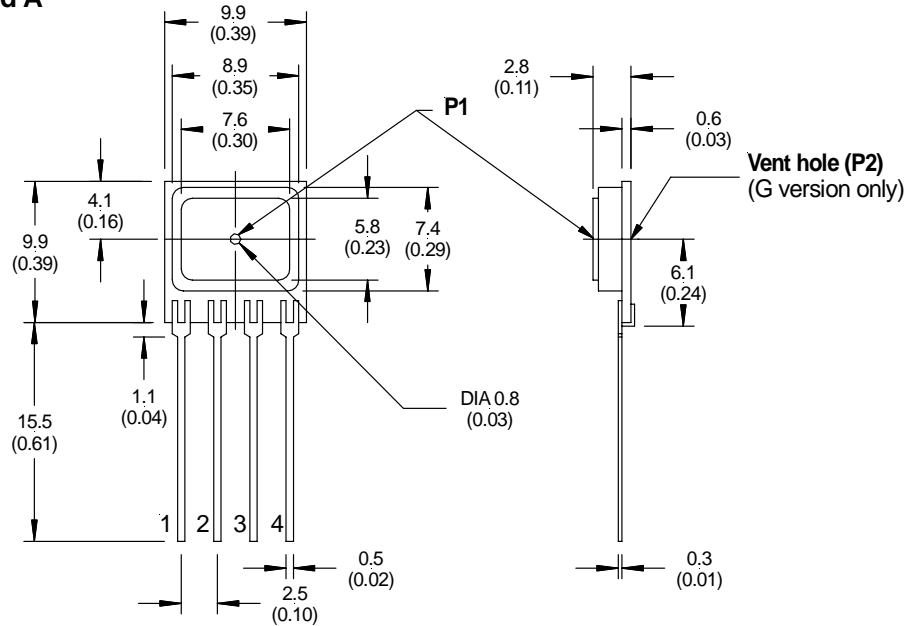

mass: approx. 2 g

dimensions in mm (inches)

Package version GF and AF

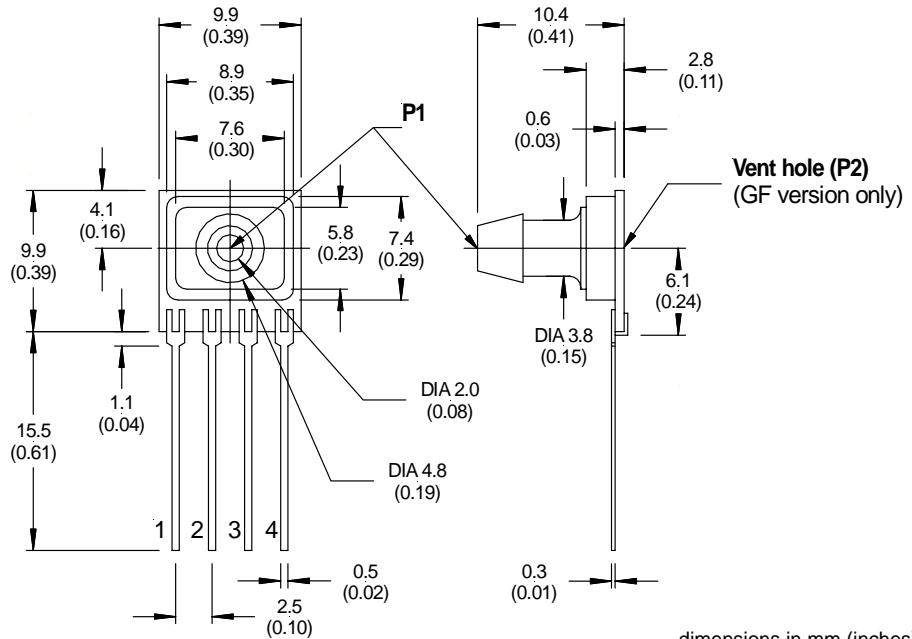

mass: approx. 2 g

dimensions in mm (inches)

OUTLINE DRAWING

Package version D

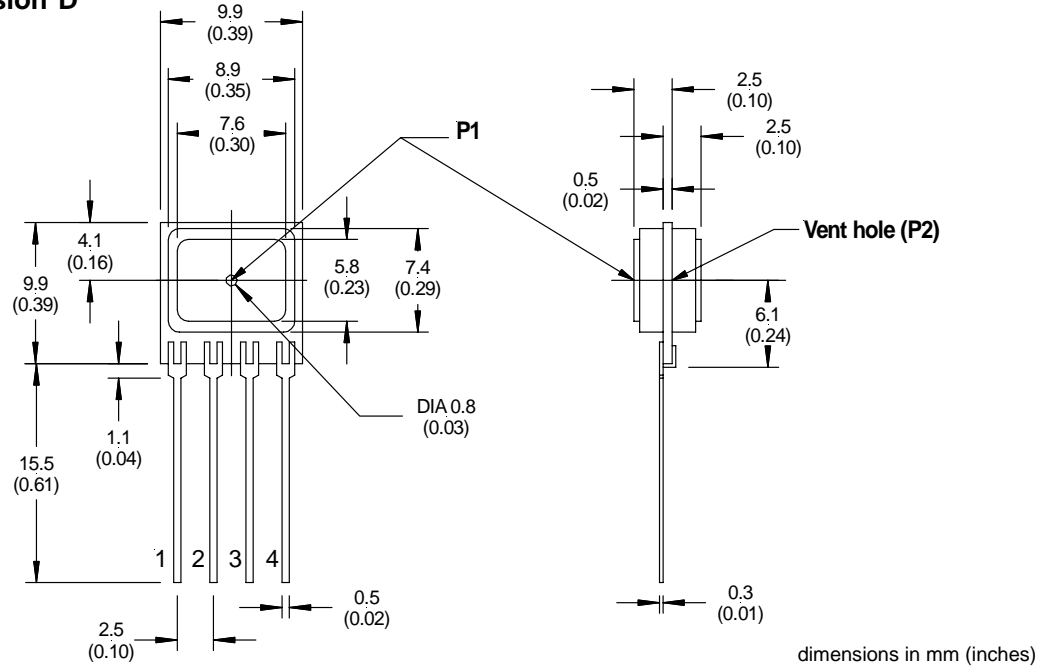

Package version DF

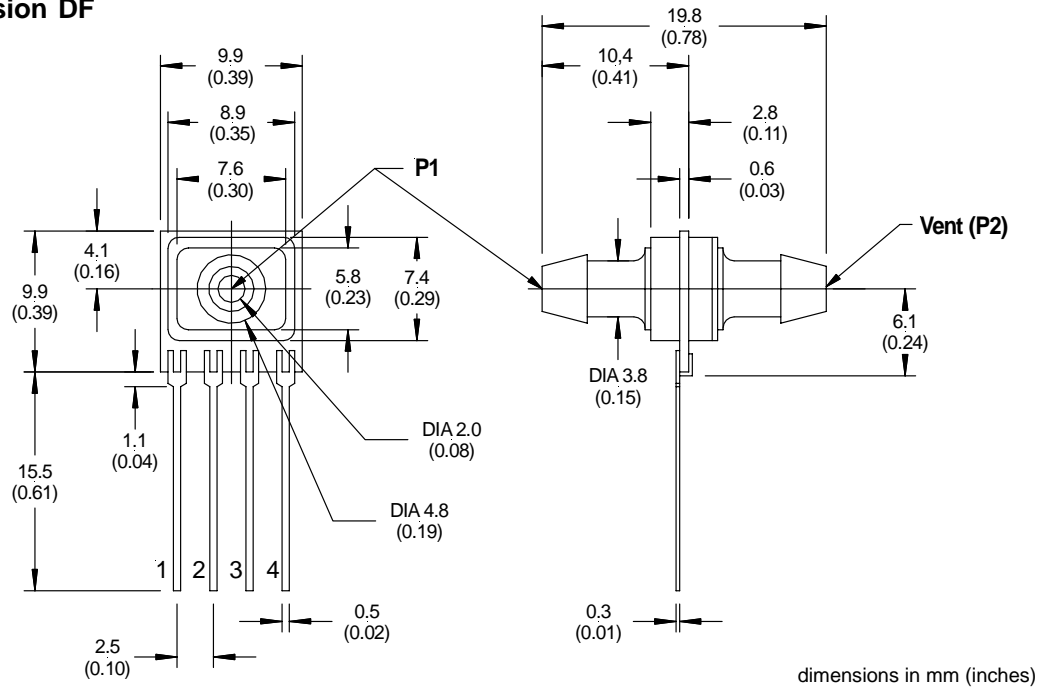

ORDERING INFORMATION

Pressure range	Absolute devices		Gage devices		Differential devices	
	No port (A)	Axial port (AF)	No port (G)	Axial port (GF)	No port (D)	Axial port (DF)
4 "H ₂ O			CPCL04GC	CPCL04GFC	CPCL04DC	CPCL04DFC
10 "H ₂ O			---	CPCL10GFC	---	CPCL10DFC
0.3 psi			CPC0.3GC	CPC0.3GFC	---	---
1 psi			---	CPC01GFC	---	CPC01DFC
5 psi			CPC05GC	CPC05GFC	---	CPC05DFC
15 psi	CPC15AC	CPC15AFC	---	CPC15GFC	---	CPC15DFC
30 psi	CPC30AC	CPC30AFC	---	---	---	---
60 psi	---	CPC60AFC	---	---	---	CPC60DFC
100 psi	---	CPC100AFC	CPC100GC	CPC100GFC	---	---
150 psi	---	---	---	CPC150GFC	---	CPC150DFC

Note

⁷ THESE DEVICES ARE AVAILABLE ON SPECIAL REQUEST. MINIMUM ORDER QUANTITY APPLIES.

Sensortechncs reserves the right to make changes to any products herein. Sensortechncs does not assume any liability arising out of the application or use of any product or circuit described herein, neither does it convey any license under its patent rights nor the rights of others.