

Radar Pulsed Power Transistor
25W, 3.1-3.4 GHz, 100µs Pulse, 10% Duty

M/A-COM Products
Released, 10 Jul 07

Features

- NPN silicon microwave power transistors
- Common base configuration
- Broadband Class C operation
- High efficiency inter-digitized geometry
- Diffused emitter ballasting resistors
- Gold metallization system
- Internal input and output impedance matching
- Hermetic metal/ceramic package
- RoHS compliant

Outline Drawing

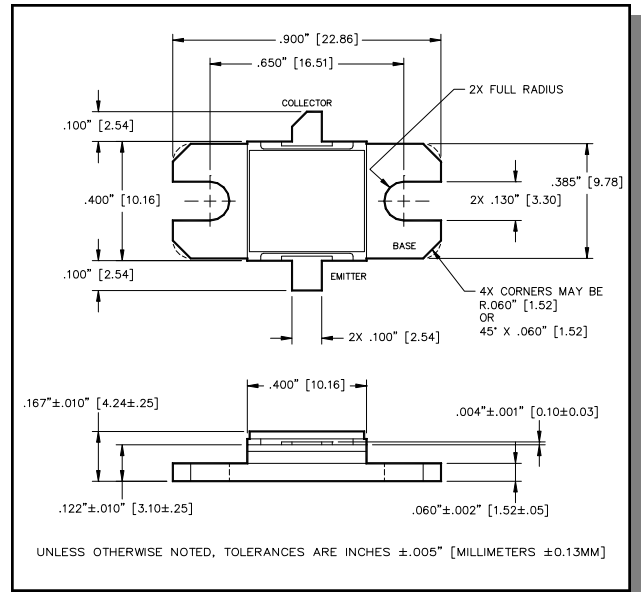

Absolute Maximum Ratings at 25°C

Parameter	Symbol	Rating	Units
Collector-Emitter Voltage	V_{CES}	65	V
Emitter-Base Voltage	V_{EBO}	3.0	V
Collector Current (Peak)	I_C	3.0	A
Power Dissipation @ +25°C	P_{TOT}	159	W
Storage Temperature	T_{STG}	-65 to +200	°C
Junction Temperature	T_J	200	°C

Electrical Specifications: $T_C = 25 \pm 5^\circ\text{C}$ (Room Ambient)

Parameter	Test Conditions	Frequency	Symbol	Min	Max	Units
Collector-Emitter Breakdown Voltage	$I_C = 10\text{mA}$		BV_{CES}	65	-	V
Collector-Emitter Leakage Current	$V_{CE} = 40\text{V}$		I_{CES}	-	1.5	mA
Thermal Resistance	$V_{CC} = 36\text{V}$, $P_{out} = 25\text{W}$	$F = 3.1, 3.25, 3.4\text{ GHz}$	$R_{TH(JC)}$	-	1.1	°C/W
Input Power	$V_{CC} = 36\text{V}$, $P_{out} = 25\text{W}$	$F = 3.1, 3.25, 3.4\text{ GHz}$	P_{IN}	-	4.45	W
Power Gain	$V_{CC} = 36\text{V}$, $P_{out} = 25\text{W}$	$F = 3.1, 3.25, 3.4\text{ GHz}$	G_P	7.5	-	dB
Collector Efficiency	$V_{CC} = 36\text{V}$, $P_{out} = 25\text{W}$	$F = 3.1, 3.25, 3.4\text{ GHz}$	η_C	35	-	%
Input Return Loss	$V_{CC} = 36\text{V}$, $P_{out} = 25\text{W}$	$F = 3.1, 3.25, 3.4\text{ GHz}$	RL	-	-6	dB
Load Mismatch Tolerance	$V_{CC} = 36\text{V}$, $P_{out} = 25\text{W}$	$F = 3.1, 3.25, 3.4\text{ GHz}$	VSWR-T	-	2:1	-

Radar Pulsed Power Transistor
25W, 3.1-3.4 GHz, 100µs Pulse, 10% Duty

M/A-COM Products
Released, 10 Jul 07

Typical RF Performance

Freq. (GHz)	Pin (W)	Pout (W)	Gain (dB)	Ic (A)	Eff (%)	RL (dB)	VSWR-T (2:1)
3.10	3.54	25.0	8.49	1.66	41.8	-10.0	-
3.25	3.57	25.0	8.45	1.73	40.1	-10.8	P
3.40	4.16	25.0	7.79	1.70	40.8	-17.6	-

Gain vs. Frequency

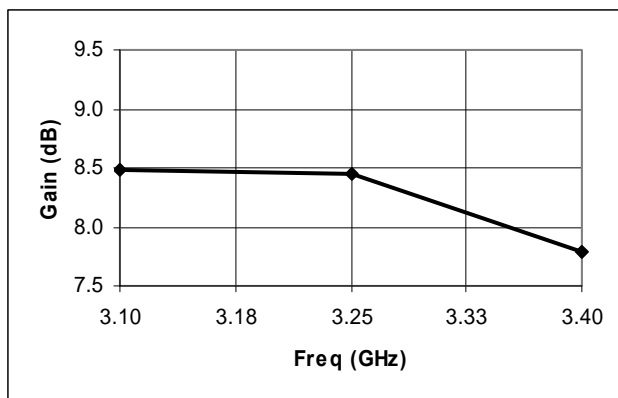

Collector Efficiency vs. Frequency

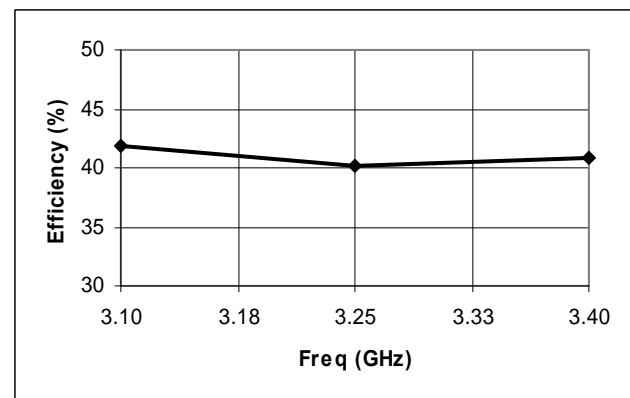

RF Test Fixture Impedance

F (GHz)	Z _{IF} (Ω)	Z _{OF} (Ω)
3.10	16.0 + j5.0	19.0 + j3.0
3.25	14.5 + j2.0	15.5 - j2.0
3.40	11.5 + j0.0	10.0 - j3.5

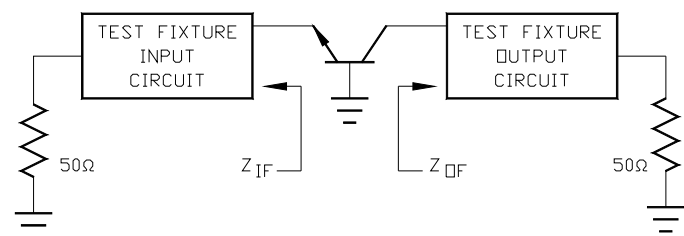

Radar Pulsed Power Transistor
25W, 3.1-3.4 GHz, 100µs Pulse, 10% Duty

M/A-COM Products
Released, 10 Jul 07

Test Fixture Circuit Dimensions

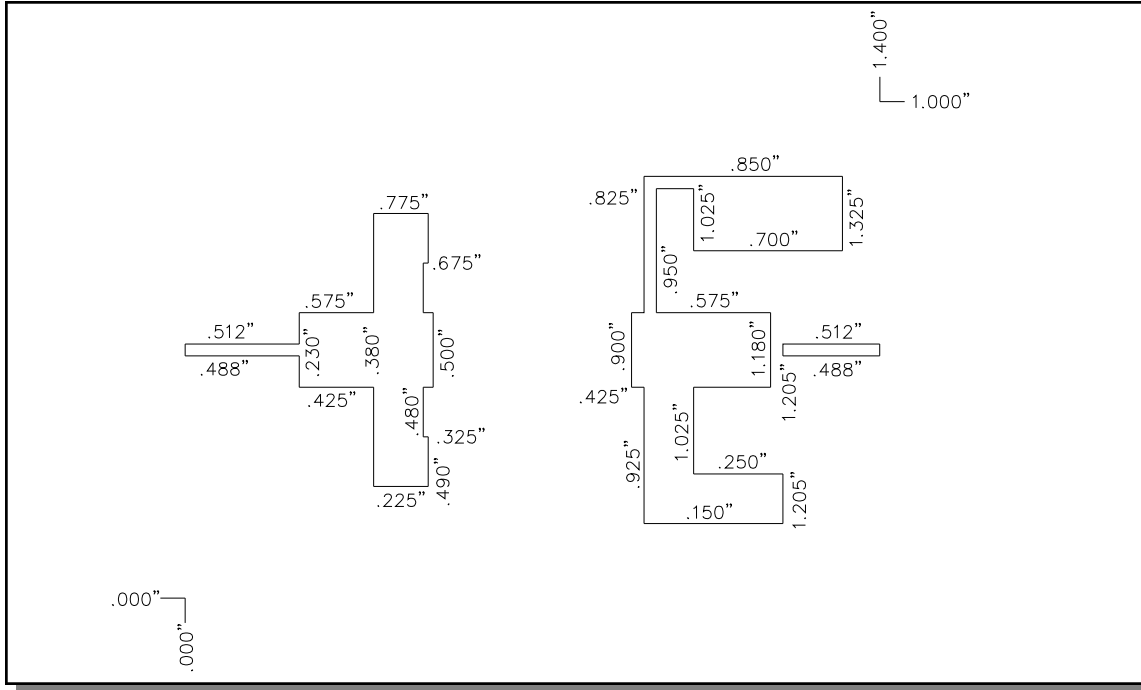

Test Fixture Assembly

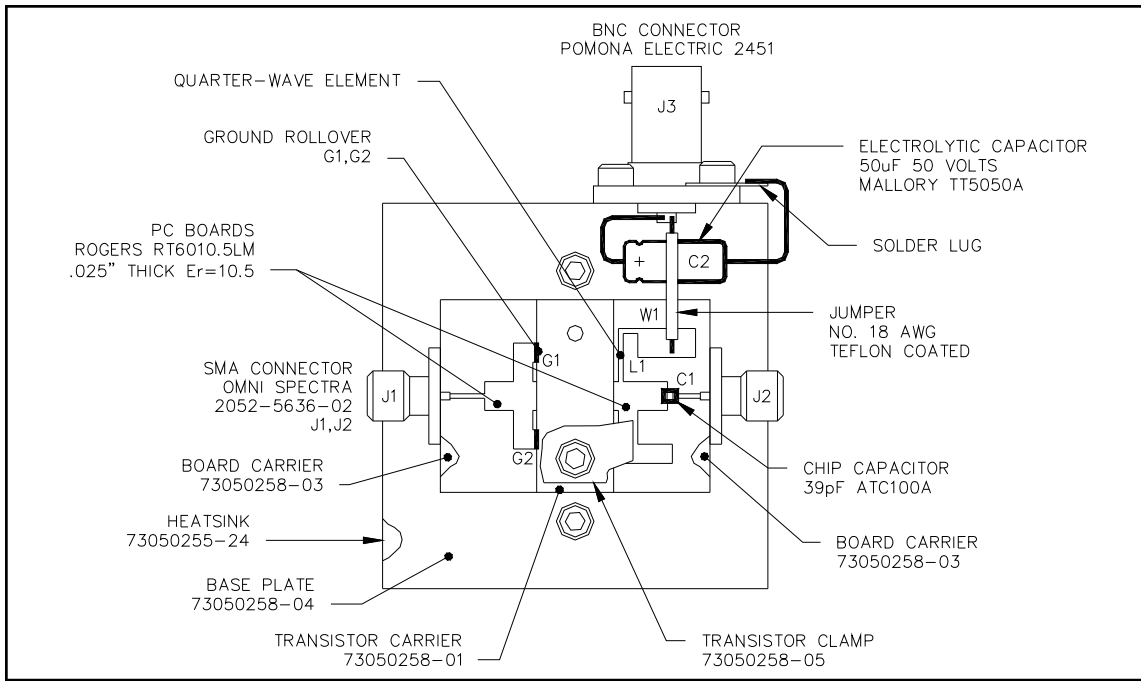

ADVANCED: Data Sheets contain information regarding a product M/A-COM Technology Solutions is considering for development. Performance is based on target specifications, simulated results, and/or prototype measurements. Commitment to develop is not guaranteed.

PRELIMINARY: Data Sheets contain information regarding a product M/A-COM Technology Solutions has under development. Performance is based on engineering tests. Specifications are typical. Mechanical outline has been fixed. Engineering samples and/or test data may be available. Commitment to produce in volume is not guaranteed.

- **North America** Tel: 800.366.2266 / Fax: 978.366.2266
 - **Europe** Tel: 44.1908.574.200 / Fax: 44.1908.574.300
 - **Asia/Pacific** Tel: 81.44.844.8296 / Fax: 81.44.844.8298
- Visit www.macomtech.com for additional data sheets and product information.

M/A-COM Technology Solutions Inc. and its affiliates reserve the right to make changes to the product(s) or information contained herein without notice.