

# Spread Spectrum Clock Generator

## Features

- 4- to 32-MHz input frequency range
- 4- to 128-MHz output frequency range
- Accepts clock, crystal, and resonator inputs
- 1x, 2x, and 4x frequency multiplication:
  - CY25811: 1x; CY25812: 2x; CY25814: 4x
- Center and down spread modulation
- Low power dissipation:
  - 3.3V = 52 mW-typ @ 6MHz
  - 3.3V = 60 mW-typ @ 12MHz
  - 3.3V = 72 mW-typ @ 24MHz
- Low cycle-to cycle jitter:
  - 8 MHz = 450 ps-max
  - 16 MHz = 225 ps-max
  - 32 MHz = 150 ps-max
- Available in 8-pin SOIC and TSSOP packages
- Commercial and industrial temperature ranges

## Applications

- Printers and MFPs
- LCD panels
- Digital copiers
- PDAs
- CD-ROM, VCD, and DVD
- Networking, LAN/WAN
- Scanners
- Modems
- Embedded digital systems

## Benefits

- Peak EMI reduction by 8 to 16 dB
- Fast time to market
- Cost reduction

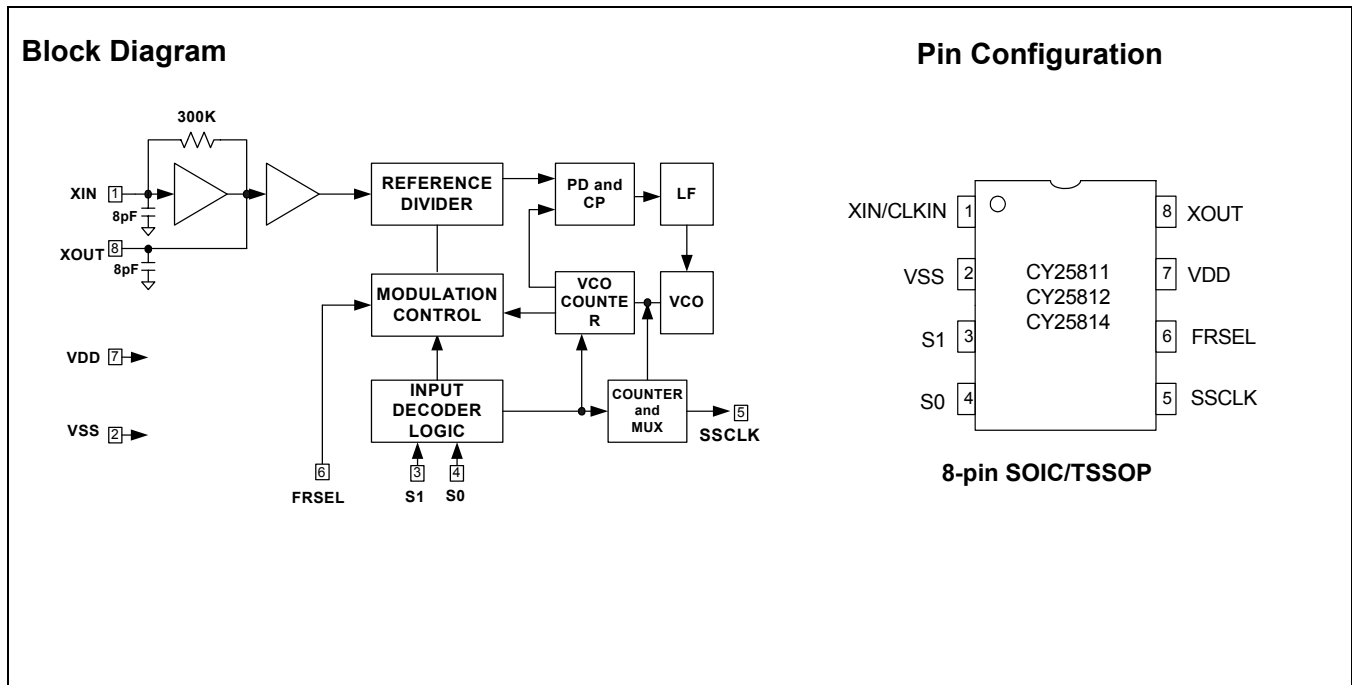

**Pin Definitions**

Pin No.	Name	Type	Description
1	Xin/CLK		<b>Crystal, ceramic resonator or clock input pin.</b>
2	VSS		<b>Power supply ground.</b>
3	S1		<b>Digital Spread% control pin.</b> 3-Level input (H-M-L). Default = M.
4	S0		<b>Digital Spread% control pin.</b> 3-Level input (H-M-L). Default = M.
5	SSCLK		<b>Spread Spectrum output clock.</b>
6	FRSEL		<b>Input frequency range selection digital control input.</b> 3-Level input (H-M-L). Default = M.
7	VDD		<b>Positive power supply.</b>
8	XOUT		<b>Crystal or ceramic resonator output pin.</b>

**Functional Description**

The CY25811/12/14 products are Spread Spectrum Clock Generator (SSCG) ICs used for the purpose of reducing electromagnetic interference (EMI) found in today's high-speed digital electronic systems.

The devices use a Cypress proprietary phase-locked loop (PLL) and Spread Spectrum Clock (SSC) technology to synthesize and modulate the frequency of the input clock. By frequency modulating the clock, the measured EMI at the fundamental and harmonic frequencies is greatly reduced.

This reduction in radiated energy can significantly reduce the cost of complying with regulatory agency requirements and improve time to market without degrading system performance.

The input frequency range is 4 to 32 MHz and accepts clock, crystal and ceramic resonator inputs. The output clock can be selected to produce 1x, 2x, or 4x multiplication of the input frequency with Spread Spectrum Frequency Modulation.

The use of 2x or 4x frequency multiplication eliminates the need for higher order crystals and enables the user to generate up to 128-MHz Spread Spectrum Clock (SSC) by using only first order crystals. This will reduce the cost while improving the system clock accuracy, performance and complexity.

Center Spread or Down Spread frequency modulation can be selected by the user based on four discrete values of

Spread % for each Spread Mode with the option of a Non-Spread mode for system test and verification purposes.

The CY25811/12/14 products are available in an 8-pin SOIC (150-mil.) package with a Commercial operating temperature range of 0 to 70°C and Industrial Temperature range of -40 to 85°C. Refer to CY25568 for multiple clock output options such as modulated and unmodulated clock outputs or Power-down function. For Automotive applications, refer to CY25811/12/14SE data sheet.

**Input Frequency Range and Selection**

The CY25811/12/14 input frequency range is 4 to 32 MHz. This range is divided into three segments and controlled by 3-Level FRSEL pin as given in *Table 1*.

**Table 1. Input Frequency Selection**

FRSEL	Input Frequency Range
0	4.0 to 8.0 MHz
1	8.0 to 16.0 MHz
M	16.0 to 32.0 MHz

**Spread% Selection**

The CY25811/12/14 SSCG products provide Center-Spread, Down-Spread and No-Spread functions. The amount of Spread% is selected by using 3-Level S0 and S1 digital inputs and Spread% values are given in *Table 2*.

**Table 2. Spread% Selection**

XIN (MHz)	FRSEL	S1 = 0	S1 = 0	S1 = 0	S1 = M	S1 = 1	S1 = 1	S1 = M	S1 = 1	S1 = M
		S0 = 0	S0 = M	S0 = 1	S0 = 0	S0 = 1	S0 = 0	S0 = 1	S0 = M	S0 = M
		Center (%)	Center (%)	Center (%)	Center (%)	Down (%)	Down (%)	Down (%)	Down (%)	No Spread
4-5	0	±1.4	±1.2	±0.6	±0.5	-3.0	-2.2	-1.9	-0.7	0
5-6	0	±1.3	±1.1	±0.5	±0.4	-2.7	-1.9	-1.7	-0.6	0
6-7	0	±1.2	±0.9	±0.5	±0.4	-2.5	-1.8	-1.5	-0.6	0
7-8	0	±1.1	±0.9	±0.4	±0.3	-2.3	-1.7	-1.4	-0.5	0
8-10	1	±1.4	±1.2	±0.6	±0.5	-3.0	-2.2	-1.9	-0.7	0
10-12	1	±1.3	±1.1	±0.5	±0.4	-2.7	-1.9	-1.7	-0.6	0
12-14	1	±1.2	±0.9	±0.5	±0.4	-2.5	-1.8	-1.5	-0.6	0
14-16	1	±1.1	±0.9	±0.4	±0.3	-2.3	-1.7	-1.4	-0.5	0
16-20	M	±1.4	±1.2	±0.6	±0.5	-3.0	-2.2	-1.9	-0.7	0

Table 2. Spread% Selection (continued)

XIN (MHz)	FRSEL	S1 = 0 S0 = 0	S1 = 0 S0 = M	S1 = 0 S0 = 1	S1 = M S0 = 0	S1 = 1 S0 = 1	S1 = 1 S0 = 0	S1 = M S0 = 1	S1 = 1 S0 = M	S1 = M S0 = M
20-24	M	±1.3	±1.1	± 0.5	± 0.4	-2.7	-1.9	-1.7	-0.6	0
24-28	M	±1.2	± 0.9	± 0.5	± 0.4	-2.5	-1.8	-1.5	-0.6	0
28-32	M	±1.1	± 0.9	± 0.4	± 0.3	-2.3	-1.7	-1.4	-0.5	0

### 3-Level Digital Inputs

S0, S1, and FRSEL digital inputs are designed to sense 3 different logic levels designated as High “1”, Low “0” and Middle “M”. With this 3-Level digital input logic, the 3-Level Logic is able to detect 9 different logic states.

S0, S1 and FRSEL pins include an on chip 20K (10K/10K) resistor divider. No external application resistors are needed to implement the 3-Level logic levels as shown below:

Logic Level “0”: 3-Level logic pin connected to GND.

Logic Level “M”: 3-Level logic pin left floating (no connection).

Logic Level “1”: 3-Level logic pin connected to V<sub>DD</sub>.

Figure 1 illustrates how to implement 3-Level Logic.

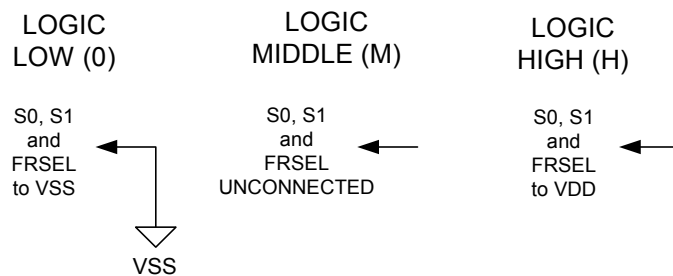

Figure 1. 3-Level Logic

### Modulation Rate

Spread Spectrum Clock Generators utilize frequency modulation (FM) to distribute energy over a specific band of frequencies. The maximum frequency of the clock (f<sub>max</sub>) and minimum frequency of the clock (f<sub>min</sub>) determine this band of frequencies. The time required to transition from f<sub>min</sub> to f<sub>max</sub> and back to f<sub>min</sub> is the period of the Modulation Rate. The Modulation Rate of SSCG clocks are generally referred to in terms of frequency, or

$$f_{mod} = 1/T_{mod}$$

The input clock frequency, f<sub>in</sub>, and the internal divider determine the Modulation Rate.

In the case of CY25811/2/4 devices, the (Spread Spectrum) modulation Rate, f<sub>mod</sub>, is given by the following formula:

$$f_{mod} = f_{in}/DR$$

where; f<sub>mod</sub> is the Modulation Rate, f<sub>in</sub> is the Input Frequency and DR is the Divider Ratio as given in Table 3. Notice that Input Frequency Range is set by FRSEL.

Table 3. Modulation Rate Divider Ratios

FRSEL	Input Frequency Range (MHz)	Divider Ratio (DR)
0	4 to 8	128
1	8 to 16	256
M	16 to 32	512

### Input and Output Frequency Selection

The relationship between input frequency versus output frequency in terms of device selection and FRSEL setting is given in Table 4. As shown, the input frequency range is selected by FRSEL and is the same for CY25811, CY25812, and CY25814. The selection of CY25811 (1x), CY25812 (2x) or CY25814 (4x) determines the frequency multiplication at the output (SSCLK, Pin 5) with respect to input frequency (XIN, Pin-1).

**Table 4. Input and Output Frequency Selection**

Input Frequency Range (MHz)	FRSEL	Product	Multiplication	Output Frequency Range (MHz)
4 to 8	0	CY25811	1x	4 to 8
8 to 16	1	CY25811	1x	8 to 16
16 to 32	M	CY25811	1x	16 to 32
4 to 8	0	CY25812	2x	8 to 16
8 to 16	1	CY25812	2x	16 to 32
16 to 32	M	CY25812	2x	32 to 64
4 to 8	0	CY25814	4x	16 to 32
8 to 16	1	CY25814	4x	32 to 64
16 to 32	M	CY25814	4x	64 to 128

**Absolute Maximum Conditions** (both Commercial and Industrial Grades)<sup>[1,2]</sup>

Parameter	Description	Condition	Min.	Max.	Unit
V <sub>DD</sub>	Supply Voltage		-0.5	4.6	V
V <sub>IN</sub>	Input Voltage	Relative to V <sub>SS</sub>	-0.5	V <sub>DD</sub> + 0.5	VDC
T <sub>S</sub>	Temperature, Storage	Non Functional	-65	150	°C
T <sub>A1</sub>	Temperature, Operating Ambient	Functional, C-Grade	0	70	°C
T <sub>A2</sub>	Temperature, Operating Ambient	Functional, I-Grade	-40	85	°C
T <sub>J</sub>	Temperature, Junction	Functional	-	150	°C
ESD <sub>HBM</sub>	ESD Protection (Human Body Model)	MIL-STD-883, Method 3015	2000	-	V
UL-94	Flammability Rating	@1/8 in.	V-0		
MSL	Moisture Sensitivity Level		1		

**DC Electrical Specifications** (Commercial Grade)

Parameter	Description	Condition	Min.	Max.	Unit
V <sub>DD</sub>	3.3 Operating Voltage	3.3 ± 5%	3.135	3.465	V
V <sub>IL</sub>	Input Low Voltage	S0, S1 and FRSEL Inputs	0	0.15V <sub>DD</sub>	V
V <sub>IM</sub>	Input Middle Voltage	S0, S1 and FRSEL Inputs	0.40V <sub>DD</sub>	0.60V <sub>DD</sub>	V
V <sub>IH</sub>	Input High Voltage	S0, S1 and FRSEL Inputs	0.85V <sub>DD</sub>	V <sub>DD</sub>	V
V <sub>OL1</sub>	Output Low Voltage	I <sub>OL</sub> = 4 ma, SSCLK Output	-	0.4	V
V <sub>OL2</sub>	Output Low Voltage	I <sub>OL</sub> = 10 ma, SSCLK Output	-	1.2	V
V <sub>OH1</sub>	Output High Voltage	I <sub>OH</sub> = 4 ma, SSCLK Output	2.4	-	V
V <sub>OH2</sub>	Output High Voltage	I <sub>OH</sub> = 6 ma, SSCLK Output	2.0	-	V
C <sub>IN1</sub>	Input Pin Capacitance	XIN (Pin 1) and XOUT (Pin 8)	6.0	9.0	pF
C <sub>IN2</sub>	Input Pin Capacitance	All Digital Inputs	3.5	6.0	pF
C <sub>L</sub>	Output Load Capacitor	SSCLK Output	-	15	pF
I <sub>DD1</sub>	Dynamic Supply Current	Fin = 12 MHz, no load	-	25	mA
I <sub>DD2</sub>	Dynamic Supply Current	Fin = 24 MHz, no load	-	30	mA
I <sub>DD3</sub>	Dynamic Supply Current	Fin = 32 MHz, no load	-	35	mA

**Notes:**

1. Operation at any Absolute Maximum Rating is not implied.
2. Single Power Supply: The voltage on any input or I/O pin cannot exceed the power pin during power up.

**AC Electrical Specifications (Commercial Grade)**

Parameter	Description	Condition	Min.	Max.	Unit
F <sub>IN</sub>	Input Frequency Range	Clock, Crystal or Ceramic Resonator Input	4	32	MHz
T <sub>R1</sub>	Clock Rise Time	SSCLK, CY25811 and CY25812	2.0	5.0	ns
T <sub>F1</sub>	Clock Fall Time	SSCLK, CY25811 and CY25812	2.0	4.4	ns
T <sub>R2</sub>	Clock Rise Time	SSCLK, only CY25814 when FRSEL = M	1.0	2.2	ns
T <sub>F2</sub>	Clock Fall Time	SSCLK, only CY25814 when FRSEL = M	1.0	2.2	ns
T <sub>DCIN</sub>	Input Clock Duty Cycle	XIN	40	60	%
T <sub>DCOUT</sub>	Output Clock Duty Cycle	SSCLK	40	60	%
T <sub>CCJ1</sub>	Cycle-to-Cycle Jitter, Spread on	Fin = 4 MHz, Fout = 4 MHz, CY25811	–	800	ps
T <sub>CCJ2</sub>	Cycle-to-Cycle Jitter, Spread on	Fin = 8 MHz, Fout = 8 MHz, CY25811	–	450	ps
T <sub>CCJ3</sub>	Cycle-to-Cycle Jitter, Spread on	Fin = 8 MHz, Fout = 16 MHz, CY25812	–	400	ps
T <sub>CCJ4</sub>	Cycle-to-Cycle Jitter, Spread on	Fin = 16 MHz, Fout = 32 MHz, CY25812	–	380	ps
T <sub>CCJ5</sub>	Cycle-to-Cycle Jitter, Spread on	Fin = 16 MHz, Fout = 64 MHz, CY25814	–	380	ps
T <sub>CCJ6</sub>	Cycle-to-Cycle Jitter, Spread on	Fin = 32 MHz, Fout = 128 MHz, CY25814	–	380	ps
T <sub>SU</sub>	PLL Lock Time	Fom V <sub>DD</sub> 3.0V to valid SSCLK	–	3	ms

**DC Electrical Specifications (Industrial Grade)**

Parameter	Description	Condition	Min.	Max.	Unit
V <sub>DD</sub>	3.3 Operating Voltage	3.3 ± 5%	3.135	3.465	V
V <sub>IL</sub>	Input Low Voltage	S0, S1 and FRSEL Inputs	0	0.13V <sub>DD</sub>	V
V <sub>IM</sub>	Input Middle Voltage	S0, S1 and FRSEL Inputs	0.40V <sub>DD</sub>	0.60V <sub>DD</sub>	V
V <sub>IH</sub>	Input High Voltage	S0, S1 and FRSEL Inputs	0.85V <sub>DD</sub>	V <sub>DD</sub>	V
V <sub>OL1</sub>	Output Low Voltage	I <sub>OL</sub> = 4 ma, SSCLK Output	–	0.4	V
V <sub>OL2</sub>	Output Low Voltage	I <sub>OL</sub> = 10 ma, SSCLK Output	–	1.2	V
V <sub>OH1</sub>	Output High Voltage	I <sub>OH</sub> = 4 ma, SSCLK Output	2.4	–	V
V <sub>OH2</sub>	Output High Voltage	I <sub>OH</sub> = 6 ma, SSCLK Output	2.0	–	V
C <sub>IN1</sub>	Input Pin Capacitance	XIN (Pin 1) and XOUT (Pin 8)	6.0	9.0	pF
C <sub>IN2</sub>	Input Pin Capacitance	All Digital Inputs	3.5	6.0	pF
C <sub>L</sub>	Output Load Capacitor	SSCLK Output	–	15	pF
I <sub>DD1</sub>	Dynamic Supply Current	Fin = 12 MHz, no load	–	26	mA
I <sub>DD2</sub>	Dynamic Supply Current	Fin = 24 MHz, no load	–	32	mA
I <sub>DD3</sub>	Dynamic Supply Current	Fin = 32 MHz, no load	–	37	mA

**AC Electrical Specifications (Industrial Grade)**

Parameter	Description	Condition	Min.	Max.	Unit
F <sub>IN</sub>	Input Frequency Range	Clock, Crystal or Ceramic Resonator Input	4	32	MHz
T <sub>R1</sub>	Clock Rise Time	SSCLK, CY25811 and CY25812	2.0	5.0	ns
T <sub>F1</sub>	Clock Fall Time	SSCLK, CY25811 and CY25812	2.0	4.4	ns
T <sub>R2</sub>	Clock Rise Time	SSCLK, only CY25814 when FRSEL = M	1.0	2.2	ns
T <sub>F2</sub>	Clock Fall Time	SSCLK, only CY25814 when FRSEL = M	1.0	2.2	ns
T <sub>DCIN</sub>	Input Clock Duty Cycle	XIN	40	60	%
T <sub>DCOUT</sub>	Output Clock Duty Cycle	SSCLK	40	60	%
T <sub>CCJ1</sub>	Cycle-to-Cycle Jitter, Spread on	Fin = 6MHz, CY25811/12/14	–	650	ps
T <sub>CCJ2</sub>	Cycle-to-Cycle Jitter, Spread on	Fin = 12MHz, CY25811/12/14	–	400	ps
T <sub>CCJ3</sub>	Cycle-to-Cycle Jitter, Spread on	Fin = 24MHz, CY25811/12/14	–	400	ps
T <sub>SU</sub>	PLL Lock Time	From V <sub>DD</sub> 3.0V to valid SSCLK	–	4	ms

### Characteristic Curves

The following curves demonstrate the characteristic behavior of the CY25811/12/14 when tested over a number of environmental and application-specific parameters. These are typical performance curves and are not meant to replace any parameter specified in DC and AC Specification tables.

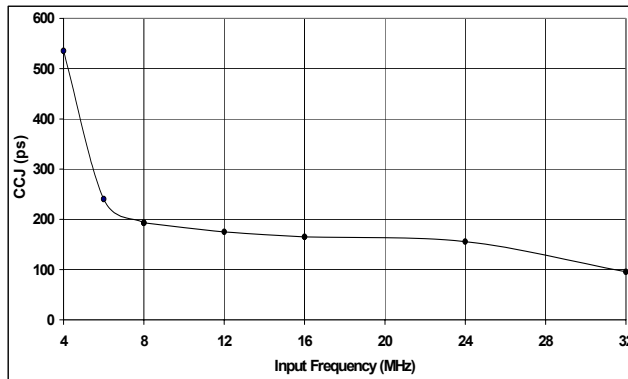

**Jitter vs. Input Frequency (No Load)**

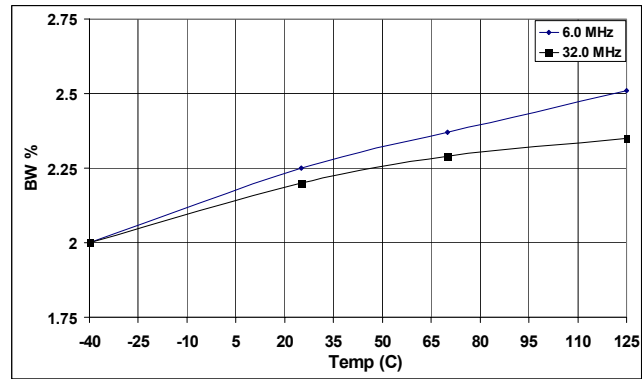

**Bandwidth % vs. Temperature**

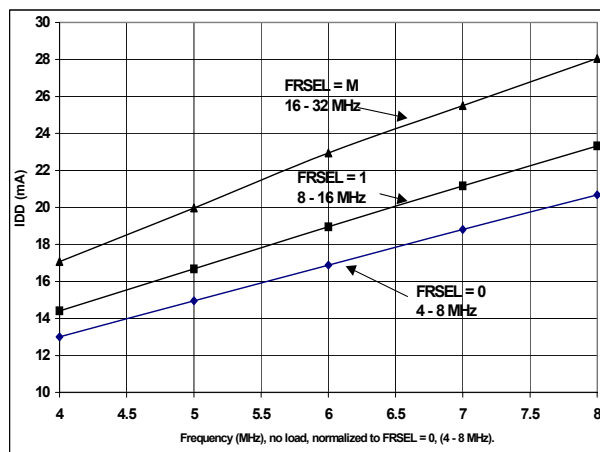

**IDD vs. Frequency (FRSEL = 0, 1, M)**

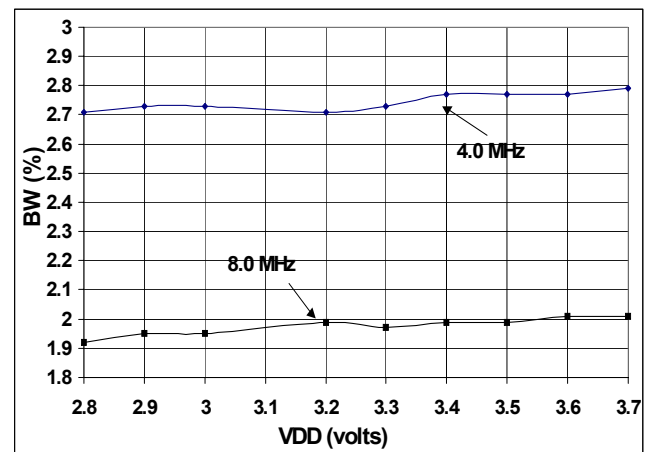

**Bandwidth % vs. VDD**

**Figure 2. Characteristic Curves**

**SSCG Profiles**

CY25811/12/14 SSCG products use a non-linear “optimized” frequency profile as shown in *Figure 3*. The use of Cypress proprietary “optimized” frequency profile maintains flat energy distribution over the fundamental and higher order harmonics. This results in additional EMI reduction in electronic systems.

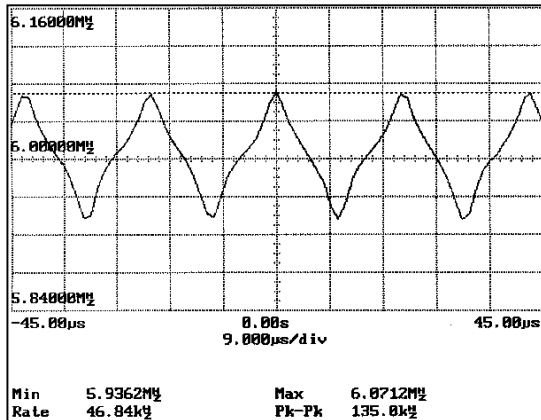

Xin = 6.0 MHz	SSCLK1 = 6.0 MHz
S1, S0 = 0	
FRSEL = 0	P/N = CY25811

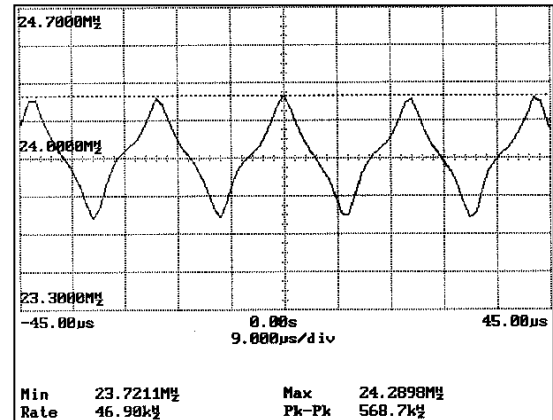

Xin = 24.0 MHz	SSCLK1 = 24.0 MHz
S1, S0 = 0	
FRSEL = M	P/N = CY25811

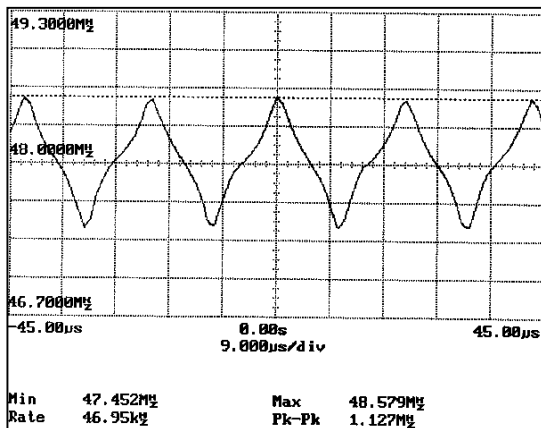

Xin = 12.0 MHz	SSCLK1 = 48.0 MHz
S1, S0 = 0	
FRSEL = 1	P/N = CY25814

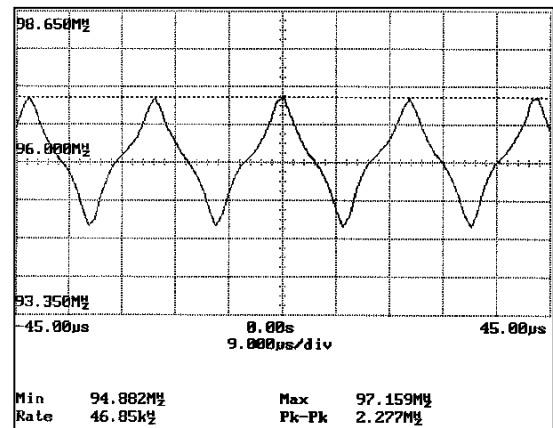

Xin = 24.0 MHz	SSCLK1 = 96.0 MHz
S1, S0 = 0	
FRSEL = M	P/N = CY25814

**Figure 3. Spread Spectrum Profiles (Frequency vs. Time)**

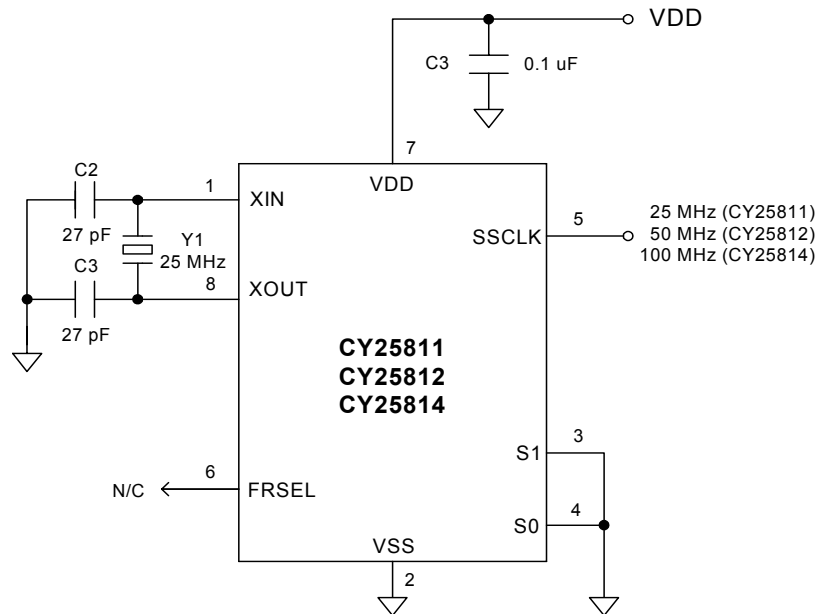
**Application Schematic**

**Ordering Information**

Part Number	Package Type	Product Flow
CY25811SC	8-pin SOIC	Commercial, 0° to 70°C
CY25811SCT	8-pin SOIC – Tape and Reel	Commercial, 0° to 70°C
CY25811SI	8-pin SOIC	Industrial, -40° to 85°C
CY25811SIT	8-pin SOIC – Tape and Reel	Industrial, -40° to 85°C
CY25811ZC	8-pin TSSOP	Commercial, 0° to 70°C
CY25811ZCT	8-pin TSSOP – Tape and Reel	Commercial, 0° to 70°C
CY25812SC	8-pin SOIC	Commercial, 0° to 70°C
CY25812SCT	8-pin SOIC – Tape and Reel	Commercial, 0° to 70°C
CY25812SI	8-pin SOIC	Industrial, -40° to 85°C
CY25812SIT	8-pin SOIC – Tape and Reel	Industrial, -40° to 85°C
CY25812ZC	8-pin TSSOP	Commercial, 0° to 70°C
CY25812ZCT	8-pin TSSOP – Tape and Reel	Commercial, 0° to 70°C
CY25814SC	8-pin SOIC	Commercial, 0° to 70°C
CY25814SCT	8-pin SOIC – Tape and Reel	Commercial, 0° to 70°C
CY25814SI	8-pin SOIC	Industrial, -40° to 85°C
CY25814SIT	8-pin SOIC – Tape and Reel	Industrial, -40° to 85°C
CY25814ZC	8-pin TSSOP	Commercial, 0° to 70°C
CY25814ZCT	8-pin TSSOP – Tape and Reel	Commercial, 0° to 70°C
<b>Lead Free Devices</b>		
CY25811SXC	8-pin SOIC	Commercial, 0° to 70°C
CY25811SXCT	8-pin SOIC – Tape and Reel	Commercial, 0° to 70°C
CY25811SXI	8-pin SOIC	Industrial, -40° to 85°C
CY25811SXIT	8-pin SOIC – Tape and Reel	Industrial, -40° to 85°C

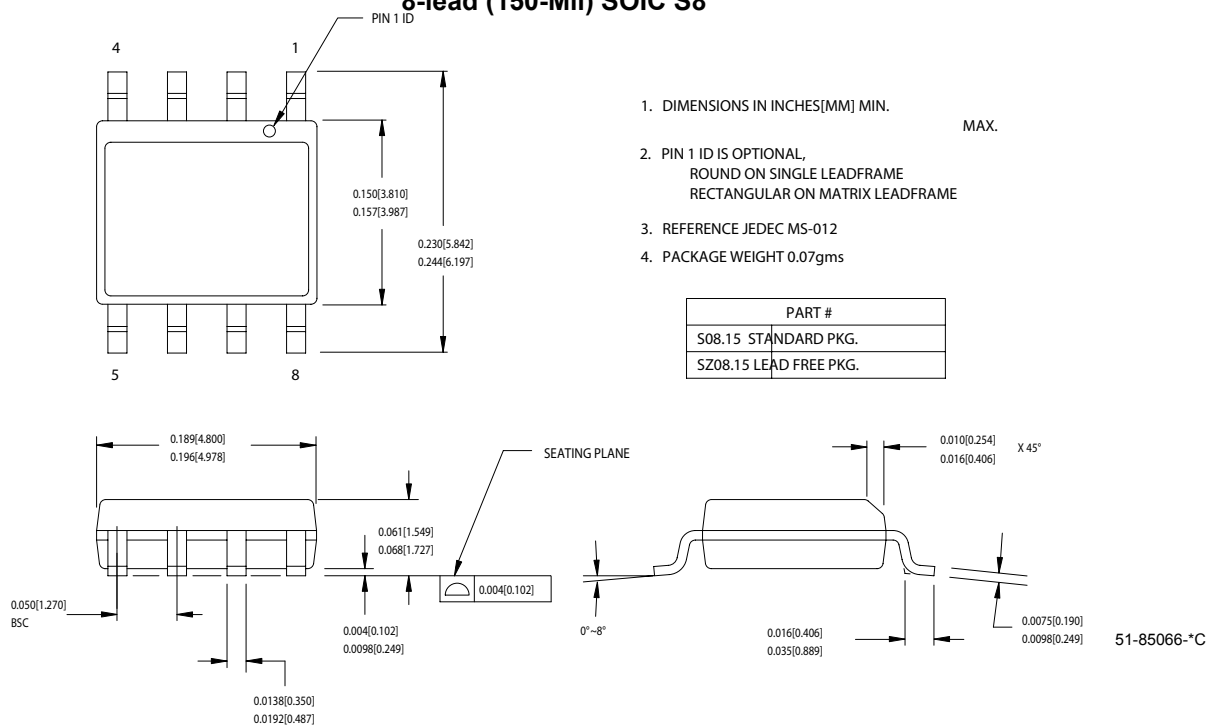

**Ordering Information** (continued)

CY25811ZXC	8-pin TSSOP	Commercial, 0° to 70°C
CY25811ZXCT	8-pin TSSOP – Tape and Reel	Commercial, 0° to 70°C
CY25812SXC	8-pin SOIC	Commercial, 0° to 70°C
CY25812SXCT	8-pin SOIC – Tape and Reel	Commercial, 0° to 70°C
CY25812SXI	8-pin SOIC	Industrial, –40° to 85°C
CY25812SXIT	8-pin SOIC – Tape and Reel	Industrial, –40° to 85°C
CY25812ZXC	8-pin TSSOP	Commercial, 0° to 70°C
CY25812ZXCT	8-pin TSSOP – Tape and Reel	Commercial, 0° to 70°C
CY25814SXC	8-pin SOIC	Commercial, 0° to 70°C
CY25814SXCT	8-pin SOIC – Tape and Reel	Commercial, 0° to 70°C
CY25814SXI	8-pin SOIC	Industrial, –40° to 85°C
CY25814SXIT	8-pin SOIC – Tape and Reel	Industrial, –40° to 85°C
CY25814ZXC	8-pin TSSOP	Commercial, 0° to 70°C
CY25814ZXCT	8-pin TSSOP – Tape and Reel	Commercial, 0° to 70°C

**Package Drawing and Dimensions**
**8-lead (150-Mil) SOIC S8**

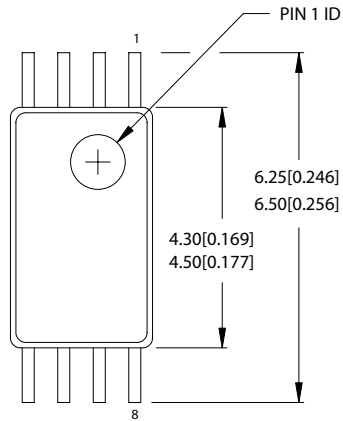
**8-Lead Thin Shrunk Small Outline Package (4.40 MM Body) Z8**

DIMENSIONS IN MM[INCHES] MIN.  
MAX.

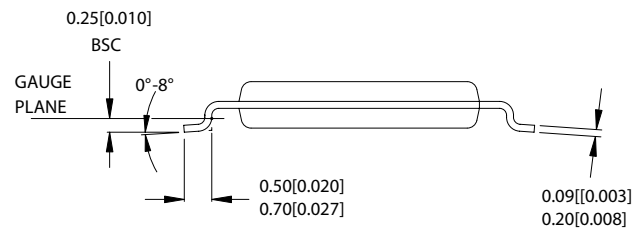
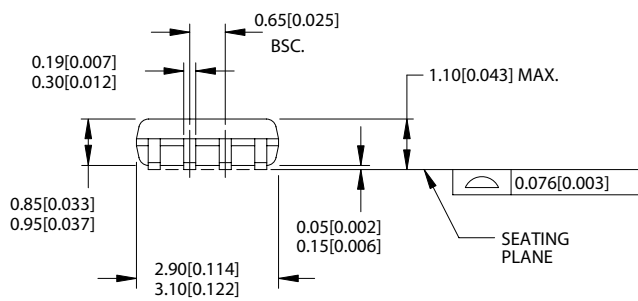

51-85093-\*A

Intel and Pentium are registered trademarks of Intel Corporation. All product and company names mentioned in this document are the trademarks of their respective holders.

**Document History Page**

Document Title: CY25811/12/14 Spread Spectrum Clock Generator				
Document Number: 38-07112				
REV.	ECN NO.	Issue Date	Orig. of Change	Description of Change
**	107516	06/14/02	NDP	Converted from IMI to Cypress
*A	108002	06/29/02	NDP	Deleted Junction Temp. in Absolute Maximum Ratings
*B	121578	01/29/03	RGL	Converted from Word to FrameMaker Added 8-pin TSSOP package in Commercial Temp. only Added an Industrial Temperature Range to all existing 8-pin SOIC packages
*C	125550	05/14/03	RGL	Changed IDD values from 19.6/22/27.2 to 25/30/35 in Commercial Grade DC Specs table Changed IDD values from 24/26.5/33 to 26/32/37 in Industrial grade DC Specs table Changed $T_{CCJ1/2}$ values from 675/260 to 800/450 in Commercial grade AC Specs table Changed $T_{CCJ1}$ value from 350 to 650 in Industrial grade AC Specs table
*D	131941	12/24/03	RGL	Removed automotive in the Applications section Changed the Output Clock Duty Cycle ( $T_{DCOUT}$ ) from min. 45 and max. 55 to 40 and 60% respectively for both industrial and commercial grade Changed the min. Input Low Voltage ( $V_{IL}$ ) from $0.15V_{DD}$ to $0.13V_{DD}$ Removed preliminary from the industrial AC/DC Electrical Specifications table
*E	231057	See ECN	RGL	Added Lead Free Devices