



## N-Channel Enhancement-Mode Vertical DMOS FETs

### Ordering Information Standard Commercial Devices

BV <sub>DSS</sub> / BV <sub>DGS</sub>	R <sub>DS(ON)</sub> (max)	I <sub>D(ON)</sub> (min)	Order Number / Package	
			TO-52	TO-92
60V	5Ω	0.75A	VN10KN9	VN10KN3

### High Reliability Devices

See pages 5-4 and 5-5 for MILITARY STANDARD Process Flows and Ordering Information.

### Features

- Free from secondary breakdown
- Low power drive requirement
- Ease of paralleling
- Low C<sub>ISS</sub> and fast switching speeds
- Excellent thermal stability
- Integral Source-Drain diode
- High input impedance and high gain
- Complementary N- and P-channel devices

### Applications

- Motor control
- Converters
- Amplifiers
- Switches
- Power supply circuits
- Drivers (relays, hammers, solenoids, lamps, memories, displays, bipolar transistors, etc.)

### Absolute Maximum Ratings

Drain-to-Source Voltage	BV <sub>DSS</sub>
Drain-to-Gate Voltage	BV <sub>DGS</sub>
Gate-to-Source Voltage	± 30V
Operating and Storage Temperature	-55°C to +150°C
Soldering Temperature*	300°C

\* Distance of 1.6 mm from case for 10 seconds.

### Advanced DMOS Technology

These enhancement-mode (normally-off) transistors utilize a vertical DMOS structure and Supertex's well-proven silicon-gate manufacturing process. This combination produces devices with the power handling capabilities of bipolar transistors and with the high input impedance and positive temperature coefficient inherent in MOS devices. Characteristic of all MOS structures, these devices are free from thermal runaway and thermally-induced secondary breakdown.

Supertex vertical DMOS FETs are ideally suited to a wide range of switching and amplifying applications where high breakdown voltage, high input impedance, low input capacitance, and fast switching speeds are desired.

### Package Options

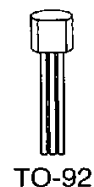

Note: See package outline section for discrete pinout.

# Thermal Characteristics

Package	$I_D$ (continuous) <sup>1,2</sup>	$I_D$ (pulsed)	Power Dissipation @ $T_C = 25^\circ\text{C}$	$\theta_{ja}$ $^\circ\text{C/W}$	$\theta_{jc}$ $^\circ\text{C/W}$	$I_{DR}$	$I_{DRM}$
TO-52	0.31A	1.0A	1.0W	170	125	0.31A	1.0A
TO-92	0.31A	1.0A	1.0W	170	125	0.31A	1.0A

**Notes:**

- $I_D$  (continuous) is limited by max rated  $T_j$ .
- VN0106N3 can be used if an  $I_D$  (continuous) of 0.5 is needed.

# Electrical Characteristics (@ $25^\circ\text{C}$ unless otherwise specified)

Symbol	Parameter	Min	Typ	Max	Unit	Conditions
$BV_{DSS}$	Drain-to-Source Breakdown Voltage	VN10K	60		V	$V_{GS} = 0V, I_D = 100\mu\text{A}$
$V_{GS(th)}$	Gate Threshold Voltage	0.8		2.5	V	$V_{GS} = V_{DS}, I_D = 1\text{mA}$
$\Delta V_{GS(th)}$	Change in $V_{GS(th)}$ with Temperature		-3.8		mV/ $^\circ\text{C}$	$V_{GS} = V_{DS}, I_D = 1\text{mA}$
$I_{GSS}$	Gate Body Leakage			100	nA	$V_{GS} = 15V, V_{DS} = 0V$
$I_{DSS}$	Zero Gate Voltage Drain Current			10	$\mu\text{A}$	$V_{GS} = 0V, V_{DS} = 45V$
				500	$\mu\text{A}$	$V_{GS} = 0V, V_{DS} = 45V, T_A 125^\circ\text{C}$
$I_{D(ON)}$	ON-State Drain Current	0.75			A	$V_{GS} = 10V, V_{DS} = 10V$
$R_{DS(ON)}$	Static Drain-to-Source ON-State Resistance			7.5	$\Omega$	$V_{GS} = 5V, I_D = 0.2A$
				5.0	$\Omega$	$V_{GS} = 10V, I_D = 0.5A$
$\Delta R_{DS(th)}$	Change in $R_{DS(th)}$ with Temperature		0.7		%/ $^\circ\text{C}$	$V_{GS} = 10V, I_D = 500\text{mA}$
$G_{FS}$	Forward Transconductance	100			mS	$V_{DS} = 10V, I_D = 500\text{mA}$
$C_{ISS}$	Input Capacitance		48	60	pF	$V_{DS} = 25V, V_{GS} = 0V$ $f = 1\text{MHz}$
$C_{OSS}$	Common Source Output Capacitance		16	25		
$C_{RSS}$	Reverse Transfer Capacitance		2	5		
$t_{(ON)}$	Turn-ON Time			10	ns	$V_{DD} = 15V, I_D = 0.6A,$ $R_{GEN} = 25\Omega$
$t_{(OFF)}$	Turn-OFF Time			10		
$V_{SD}$	Diode Forward Voltage Drop		0.8		V	$V_{GS} = 0V, I_{SD} = 0.5A$
$t_{rr}$	Reverse Recovery Time		160		ns	$V_{GS} = 0, I_{SD} = 0.5A$

**Notes:**

- All D.C. parameters 100% tested at  $25^\circ\text{C}$  unless otherwise stated. (Pulse test: 300 $\mu\text{s}$  pulse, 2% duty cycle.)
- All A.C. parameters sample tested.

# Switching Waveforms and Test Circuit

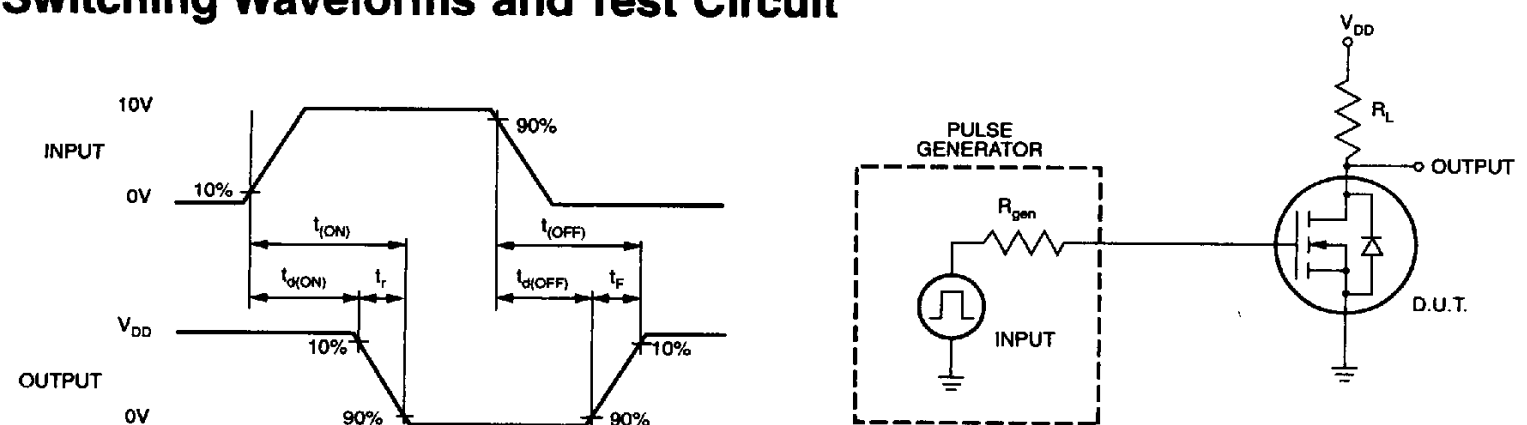

# Typical Performance Curves

Output Characteristics

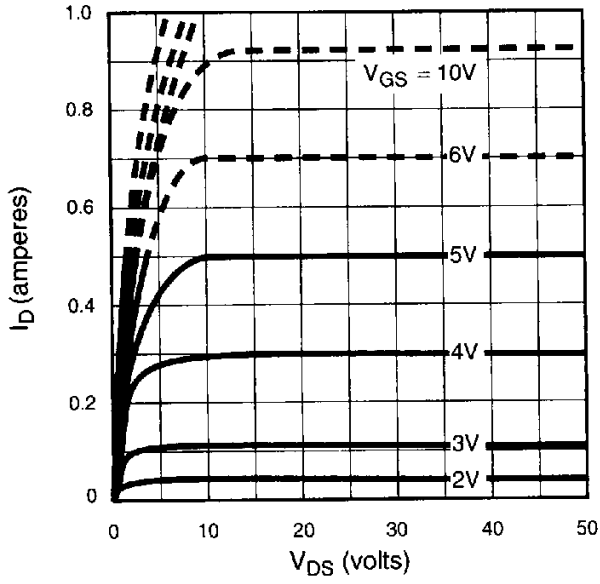

Saturation Characteristics

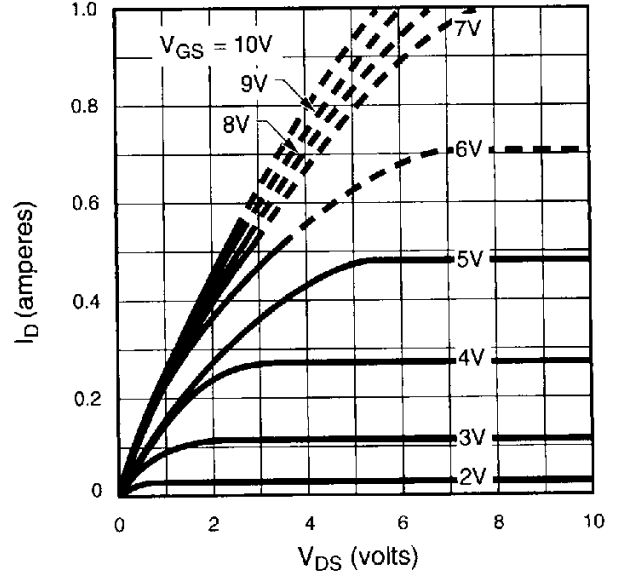

Transconductance vs. Drain Current

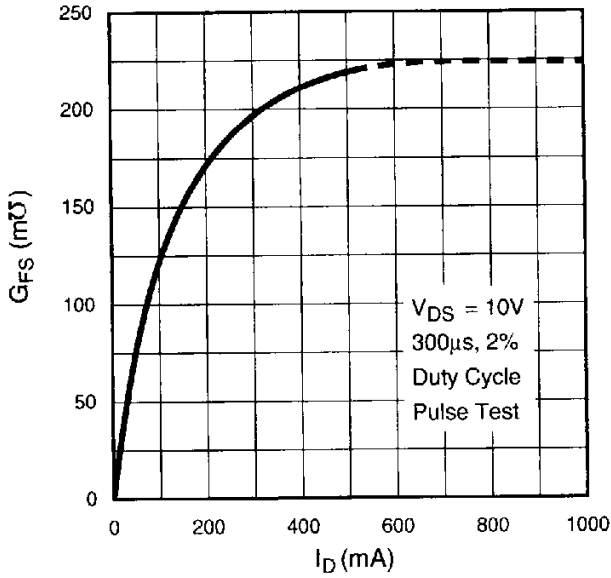

Power Dissipation vs. Case Temperature

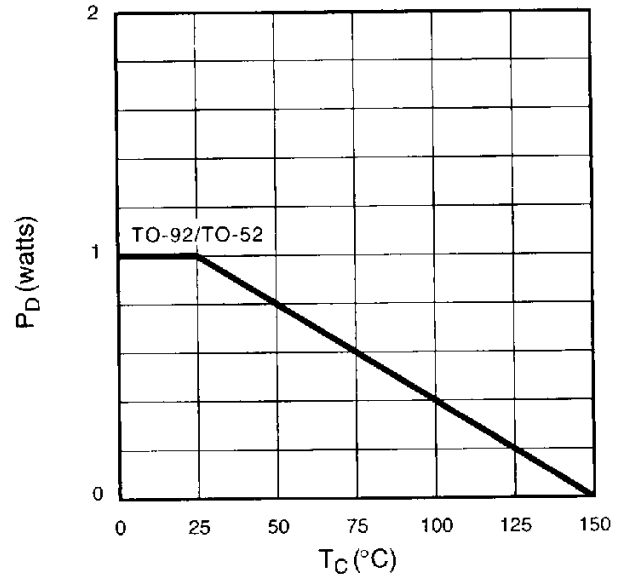

Maximum Rated Safe Operating Area

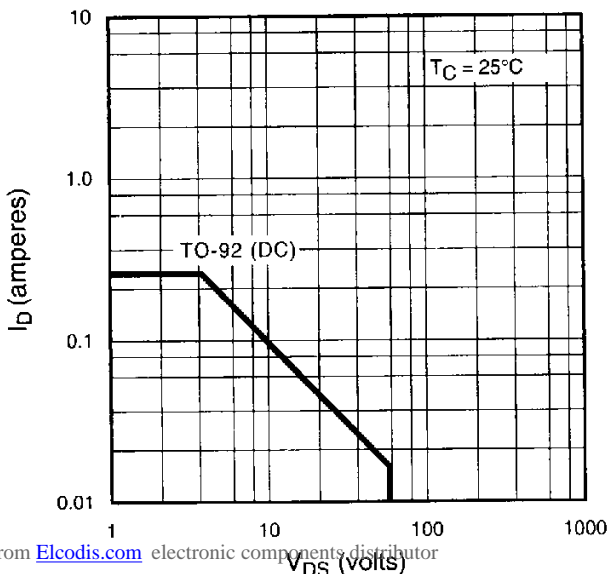

Switching Waveform

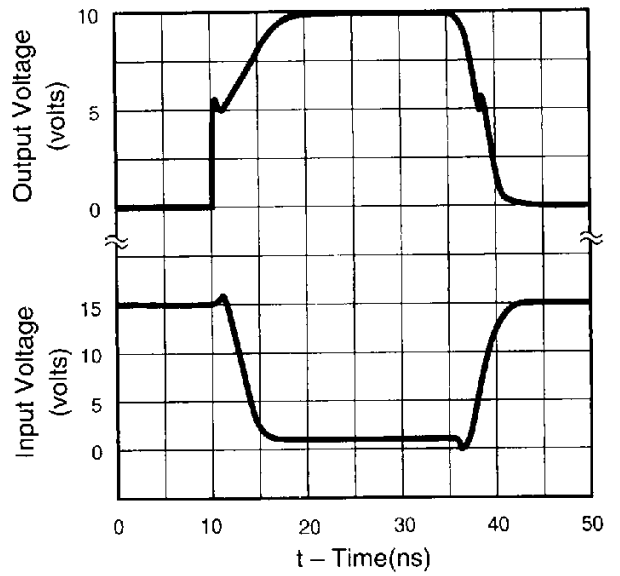

# Typical Performance Curves

## BV<sub>DSS</sub> Variation with Temperature

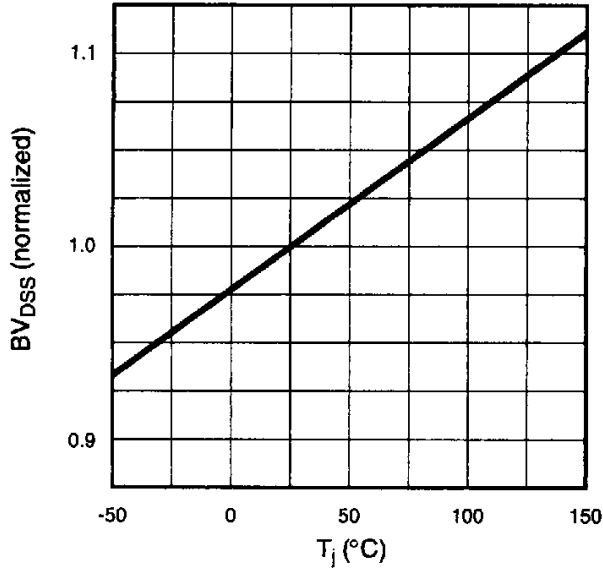

## On-Resistance vs. Gate-to-Source Voltage

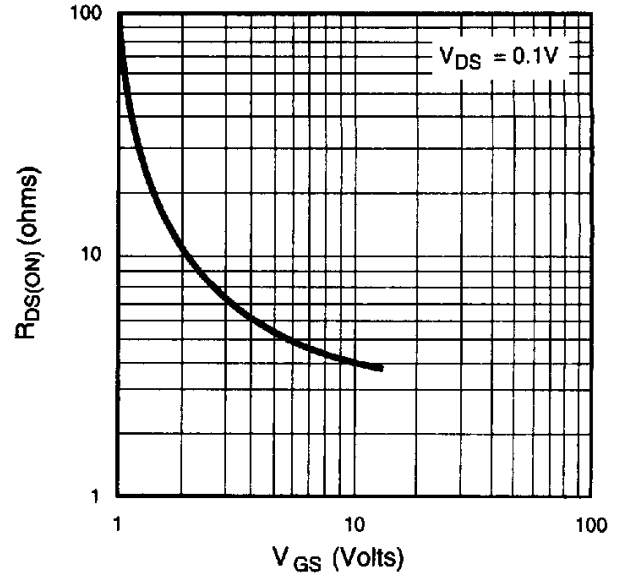

## Transfer Characteristics

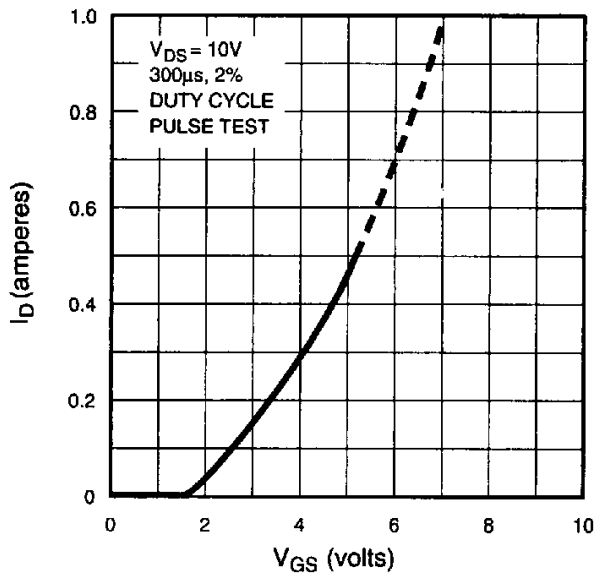

## Output Conductance vs Drain Current

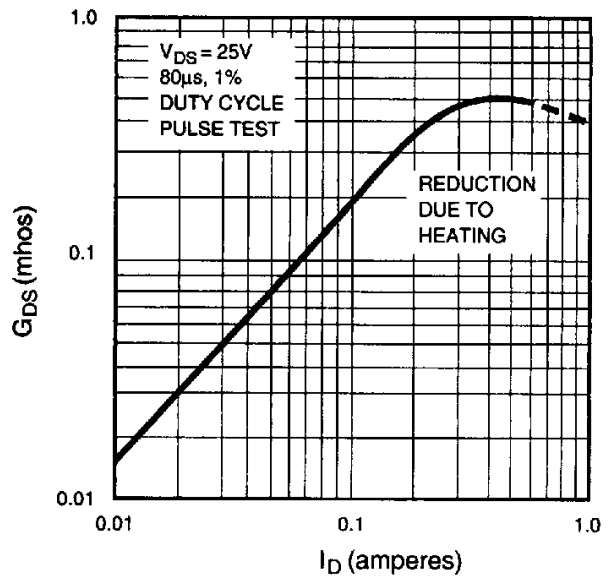

## Capacitance vs. Drain-to-Source Voltage

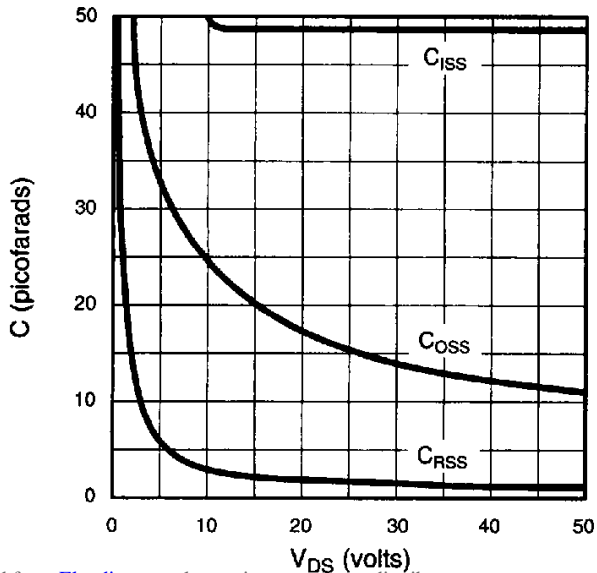

## Transconductance vs Gate-Source Voltage

