

MPEG Clock Generator with VCXO

Features

- Integrated phase-locked loop (PLL)
- Low-jitter, high-accuracy outputs
- VCXO with analog adjust
- 3.3V operation
- 8-pin SOIC package

Benefits

- Highest-performance PLL tailored for multimedia applications
- Meets critical timing requirements in complex system designs
- Large ± 150 -ppm range, better linearity
- Enables application compatibility

Part Number	Outputs	Input Frequency Range	Output Frequencies	VCXO Profile
CY2412-1	3	13.5-MHz pullable crystal input per Cypress specification	Two 27 MHz outputs, one 54 MHz (3.3V)	Linear
CY2412-3	3	13.5-MHz pullable crystal input per Cypress specification	27 MHz, 13.5 MHz, 54 MHz (3.3V)	Linear

Logic Block Diagram

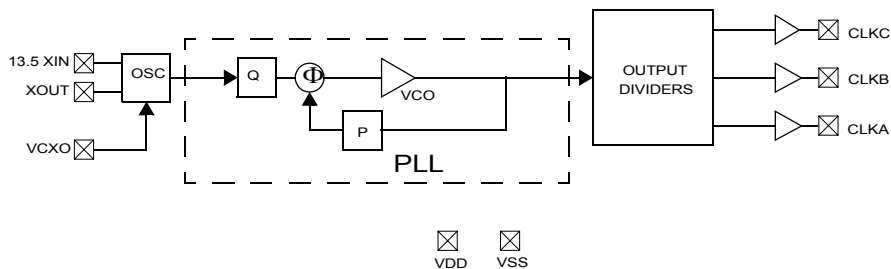

Pin Configuration

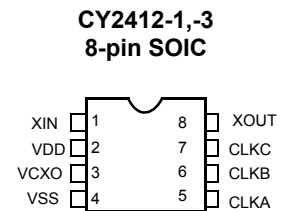

Pin Summary

Pin Name	Pin Number	Pin Description
X _{IN}	1	Reference Crystal Input
V _{DD}	2	Voltage Supply
VCXO	3	Input Analog Control for VCXO
V _{SS}	4	Ground
CLKA	5	54-MHz clock output
CLKB	6	13.5-MHz clock output
CLKC	7	27-MHz clock output
X _{OUT} ^[2]	8	Reference Crystal Output

Pullable Crystal Specifications^[1]

Parameter	Description	Condition	Min.	Typ.	Max.	Unit
F _{NOM}	Nominal crystal frequency	Parallel resonance, fundamental mode, AT cut	–	13.5	–	MHz
C _{LNOM}	Nominal load capacitance		–	14	–	pF
R ₁	Equivalent series resistance (ESR)	Fundamental mode	–	–	25	Ω
R ₃ /R ₁	Ratio of third overtone mode ESR to fundamental mode ESR	Ratio used because typical R ₁ values are much less than the maximum spec.	3	–	–	
DL	Crystal drive level	No external series resistor assumed	–	0.5	2.0	mW
F _{3SEPHI}	Third overtone separation from 3*F _{NOM}	High side	300	–	–	ppm
F _{3SEPLO}	Third overtone separation from 3*F _{NOM}	Low side	–	–	–150	ppm
C ₀	Crystal shunt capacitance		–	–	7	pF
C ₀ /C ₁	Ratio of shunt to motional capacitance		180	–	250	
C ₁	Crystal motional capacitance		14.4	18	21.6	pF

Note:

1. Crystals that meet this specification includes: Ecliptek ECX-5788-13.500M, Siward XTL001050A-13.5-14-400, Raltron A-13.500-14-CL, PDI HA13500XFSA14XC.

Absolute Maximum Conditions

Parameter	Description	Min.	Max.	Unit
V _{DD}	Supply Voltage	-0.5	7.0	V
T _S	Storage Temperature ^[3]	-65	125	°C
T _J	Junction Temperature	-	125	°C
	Digital Inputs	V _{SS} - 0.3	V _{DD} + 0.3	V
	Digital Outputs referred to V _{DD}	V _{SS} - 0.3	V _{DD} + 0.3	V
	Electrostatic Discharge	2		kV

Recommended Operating Conditions

Parameter	Description	Min.	Typ.	Max.	Unit
V _{DD}	Operating Voltage	3.14	3.3	3.47	V
T _A	Ambient Temperature	0		70	°C
C _{LOAD}	Max. Load Capacitance			15	pF
f _{REF}	Reference Frequency		13.5		MHz
t _{PU}	Power-up time for all VDDs to reach minimum specified voltage (power ramps must be monotonic)	0.05		500	ms

DC Electrical Characteristics

Parameter	Description	Test Conditions	Min.	Typ.	Max.	Unit
I _{OH}	Output High Current	V _{OH} = V _{DD} - 0.5, V _{DD} = 3.3V	12	24		mA
I _{OL}	Output Low Current	V _{OL} = 0.5, V _{DD} = 3.3V	12	24		mA
C _{IN}	Input Capacitance				7	pF
I _{IZ}	Input Leakage Current			5		μA
f _{ΔXO}	VCXO pullability range		±150			ppm
V _{VCXO}	VCXO input range		0		V _{DD}	V
f _{VBW}	VCXO input bandwidth			DC to 200		kHz
I _{DD}	Supply Current	Sum of Core and Output Current			35	mA

AC Electrical Characteristics

Parameter ^[4]	Description	Test Conditions	Min.	Typ.	Max.	Unit
DC	Output Duty Cycle	Duty Cycle is defined in <i>Figure 1</i> , 50% of V _{DD}	45	50	55	%
ER	Rising Edge Rate	Clock Edge Rate, Measured from 20% to 80% of V _{DD} , C _{LOAD} = 15 pF. See <i>Figure 2</i> .	0.8	1.4		V/ns
EF	Falling Edge Rate	Output Clock Edge Rate, Measured from 80% to 20% of V _{DD} , C _{LOAD} = 15 pF. See <i>Figure 2</i> .	0.8	1.4		V/ns
t _g	Clock Jitter	Peak to Peak period jitter		100	200	ps
t ₁₀	PLL Lock Time				3	ms

Notes:

2. Float X_{OUT} if X_{IN} is externally driven.
3. Rated for ten years.
4. Not 100% tested.

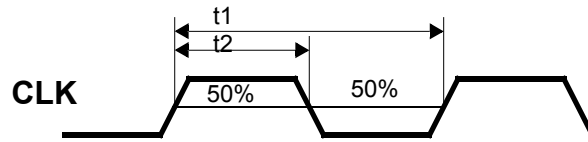

Figure 1. Duty Cycle Definition; $DC = t2/t1$

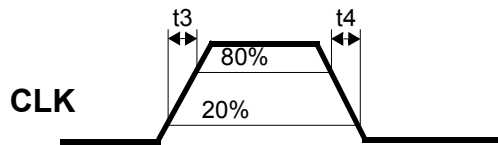
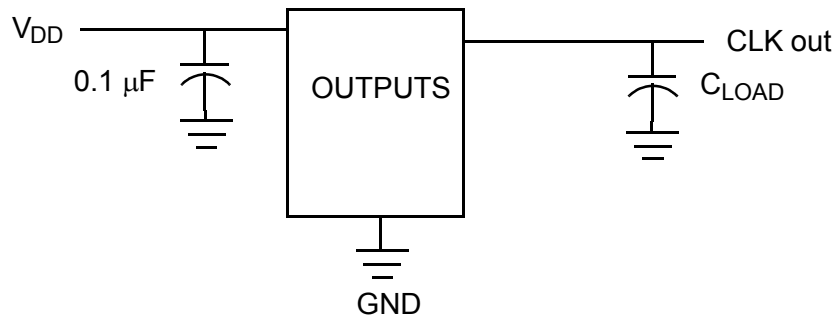

Figure 2. Rise and Fall Time Definitions: $ER = 0.6 \times VDD / t3$, $EF = 0.6 \times VDD / t4$

Test Circuit



Ordering Information

Ordering Code	Package Type	Operating Range	Operating Voltage
CY2412SC-1	8-pin SOIC	Commercial	3.3V
CY2412SC-1T	8-pin SOIC–Tape and Reel	Commercial	3.3V
CY2412SC-3	8-pin SOIC	Commercial	3.3V
CY2412SC-3T	8-pin SOIC–Tape and Reel	Commercial	3.3V
Lead-free			
CY2412SXC-1	8-pin SOIC	Commercial	3.3V
CY2412SXC-1T	8-pin SOIC–Tape and Reel	Commercial	3.3V
CY2412SXC-3	8-pin SOIC	Commercial	3.3V
CY2412SXC-3T	8-pin SOIC–Tape and Reel	Commercial	3.3V

Package Diagram

8-lead (150-Mil) SOIC S8

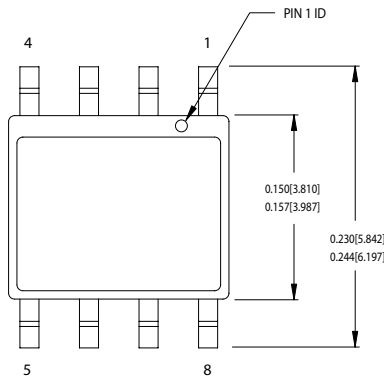

1. DIMENSIONS IN INCHES[MM] MIN. MAX.
2. PIN 1 ID IS OPTIONAL, ROUND ON SINGLE LEADFRAME RECTANGULAR ON MATRIX LEADFRAME
3. REFERENCE JEDEC MS-012
4. PACKAGE WEIGHT 0.07gms

PART #	
S08.15	STANDARD PKG.
SZ08.15	LEAD FREE PKG.

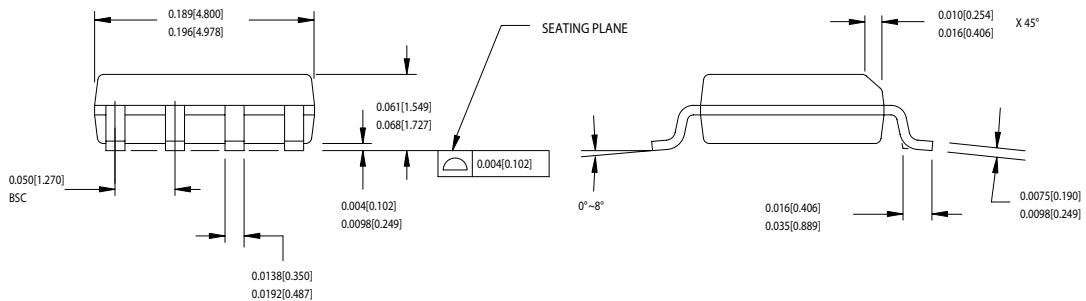

51-85066-C

All products and company names mentioned in this document may be the trademarks of their respective holders.

Document History Page

Document Title: CY2412 MPEG Clock Generator with VCXO				
Document Number: 38-07227				
REV.	ECN NO.	Issue Date	Orig. of Change	Description of Change
**	110492	10/28/01	SZV	Change from Spec number: 38-00898 to 38-07227
*A	112457	03/14/02	CKN	Added CY2412-2 to data sheet
*B	116961	08/06/02	CKN	Removed CY2412-2 from the datasheet. Added CY2412-3 to data sheet
*C	121879	12/14/02	RBI	Power-up requirements added to Operating Conditions Information
*D	299735	See ECN	RGL	Added lead-free for CY2412-1 and CY2412-3 devices