

Notice for TAIYO YUDEN products

Please read this notice before using the TAIYO YUDEN products.

REMINDERS

- Product information in this catalog is as of October 2009. All of the contents specified herein are subject to change without notice due to technical improvements, etc. Therefore, please check for the latest information carefully before practical application or usage of the Products.

Please note that Taiyo Yuden Co., Ltd. shall not be responsible for any defects in products or equipment incorporating such products, which are caused under the conditions other than those specified in this catalog or individual specification.

- Please contact Taiyo Yuden Co., Ltd. for further details of product specifications as the individual specification is available.
- Please conduct validation and verification of products in actual condition of mounting and operating environment before commercial shipment of the equipment.
- All electronic components or functional modules listed in this catalog are developed, designed and intended for use in general electronics equipment.(for AV, office automation, household, office supply, information service, telecommunications, (such as mobile phone or PC) etc.). Before incorporating the components or devices into any equipment in the field such as transportation,(automotive control, train control, ship control), transportation signal, disaster prevention, medical, public information network (telephone exchange, base station) etc. which may have direct influence to harm or injure a human body, please contact Taiyo Yuden Co., Ltd. for more detail in advance. Do not incorporate the products into any equipment in fields such as aerospace, aviation, nuclear control, submarine system, military, etc. where higher safety and reliability are especially required.

In addition, even electronic components or functional modules that are used for the general electronic equipment, if the equipment or the electric circuit require high safety or reliability function or performances, a sufficient reliability evaluation check for safety shall be performed before commercial shipment and moreover, due consideration to install a protective circuit is strongly recommended at customer's design stage.

- The contents of this catalog are applicable to the products which are purchased from our sales offices or distributors (so called "TAIYO YUDEN' s official sales channel"). It is only applicable to the products purchased from any of TAIYO YUDEN' s official sales channel.
- Please note that Taiyo Yuden Co., Ltd. shall have no responsibility for any controversies or disputes that may occur in connection with a third party's intellectual property rights and other related rights arising from your usage of products in this catalog. Taiyo Yuden Co., Ltd. grants no license for such rights.
- Caution for export**
Certain items in this catalog may require specific procedures for export according to "Foreign Exchange and Foreign Trade Control Law" of Japan, "U.S. Export Administration Regulations", and other applicable regulations. Should you have any question or inquiry on this matter, please contact our sales staff.
Should you have any question or inquiry on this matter, please contact our sales staff.



REFLOW

FEATURES

- Compact and Low-profile
- Wide bandwidth and High Gain
- Stable temperature characteristics

APPLICATIONS

- Bluetooth®, Wireless LAN, GPS, WiMAX, ZigBee, UWB

ORDERING CODE

A F △ 2 1 6 M 2 4 5 0 0 1 - T

1 Type

AH	Multilayer Antenna
AF	Helical Antenna

2 Electrode Code

△	With Plating
---	--------------

△=Blank space

3 Dimensions (case size) [mm]

216	2.5×1.6
816	8.0×1.6
116	11.0×1.6
316	3.2×1.6
083	8.0×3.0
104	10.0×4.0
122	12.0×2.0
086	8.0×6.0

4 Special Code

F	Inverted F
M	Mono Pole
N	Mono Pole (Dual)

5 Frequency [MHz]

example	
1575	1574.397~1576.443
2450	2400~2500
5550	3100~8000

1. Describe Center Frequency
2. Lower Frequency for Dualband

6 Spec Code

01~	
S1~	Applicable to AH104F

7 Packaging

-T	Tape & Reel
----	-------------

EXTERNAL DIMENSIONS/STANDARD QUANTITY

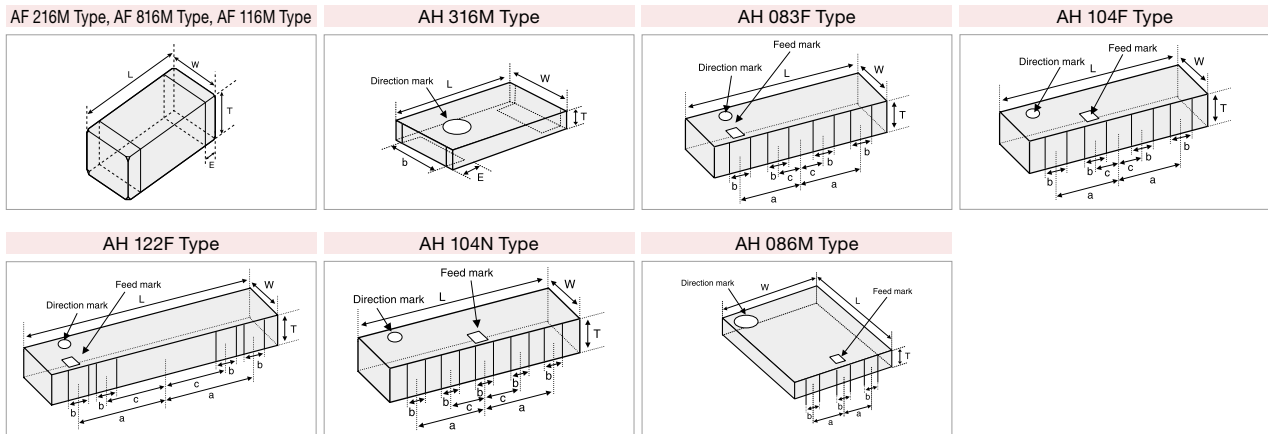

Type	L	W	T	E	a	b	c	Standard Quantity (pcs) Embossed Tape
AF 216M	2.5±0.2	1.6±0.2	1.6±0.2	0.5±0.3	—	—	—	2000
AF 816M	8±0.2	1.6±0.2	1.6±0.2	0.5±0.3	—	—	—	
AF 116M	11±0.2	1.6±0.2	1.6±0.2	0.5±0.3	—	—	—	
AH 316M	3.2±0.15	1.6±0.15	0.5±0.1	0.5±0.2	—	1.0 min.	—	3000
AH 083F	8±0.3	3±0.3	1±0.3	—	3.1±0.3	1±0.3	1.15±0.3	1000
AH 104F	10±0.3	4±0.3	1±0.3	—	2.5±0.3	1±0.3	1±0.3	2000
AH 122F	12±0.3	2±0.3	0.95±0.3	—	5.1±0.3	1±0.3	3.1±0.3	
AH 104N	10±0.3	4±0.3	1±0.3	—	3±0.3	0.8±0.3	1.5±0.3	
AH 086M	8±0.3	6±0.3	1±0.3	—	1.8±0.2	1±0.3	—	1000

Unit : mm (inch)

PART NUMBERS

Applications	Ordering Code	External Dimensions (mm)	Center Frequency (MHz)
GPS	AF816M157502	8.0×1.6×1.6	1575
	AF116M157502	11.0×1.6×1.6	1575
	AH316M157501	3.2×1.6×0.5	1575
W-LAN (2.4GHz) Bluetooth® WiMAX (2.5GHz) ZigBee	AF216M245001	2.5×1.6×1.6	2450
	AH316M245001	3.2×1.6×0.5	2450
	AH083F245001	8.0×3.0×1.0	2450
	AH104F2450S1	10.0×4.0×1.0	2450
	AH104F2650S1	10.0×4.0×1.0	2650
	AH122F245001	12.0×2.0×0.95	2450
W-LAN (2.4GHz/5GHz)	AH104N2450D1	10.0×4.0×1.0	2450/5400
UWB & WiMAX (3.5GHz)	AH086M555001	8.0×6.0×1.0	5550
	AH086M555003	8.0×6.0×1.0	5550

* This catalog contains the typical specification only due to the limitation of space. When you consider purchase of our products, please check our specification. For details of each product (characteristics graph, reliability information, precautions for use, and so on), see our Web site (<http://www.ty-top.com/>) or CD catalogs.

Typical Characteristics on Taiyo Yuden evaluation board

● AF 816M157502

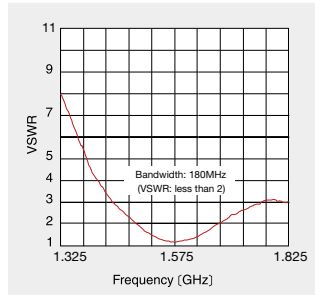

Typical characteristics of VSWR

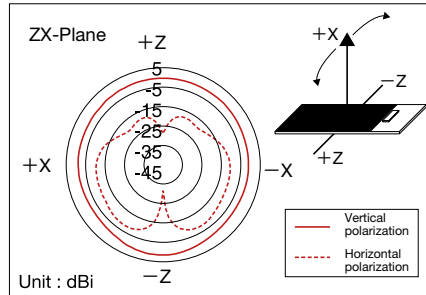

Typical characteristics of radiation pattern (@1.575GHz)

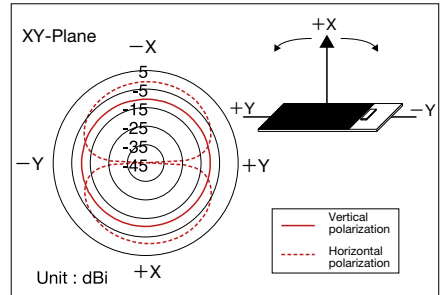

● AH 116M157502

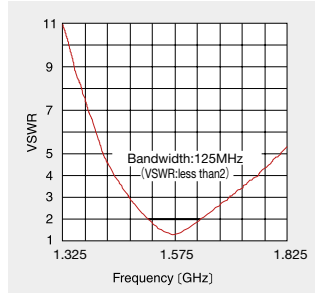

Typical characteristics of VSWR

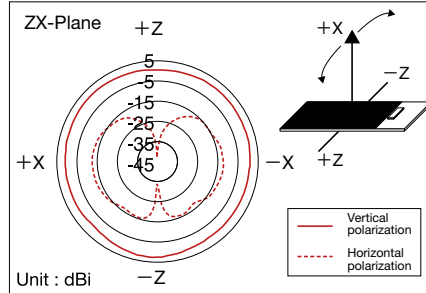

Typical characteristics of radiation pattern (@1.575GHz)

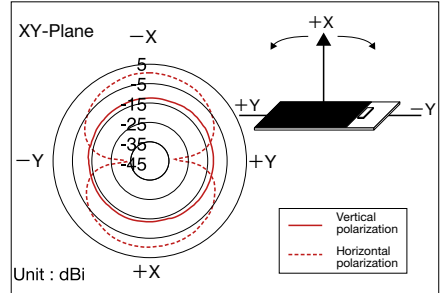

● AH 316M157501

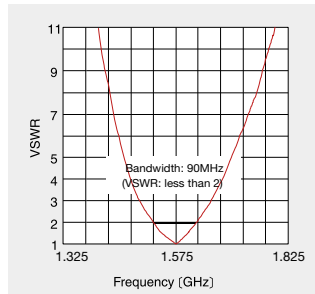

Typical characteristics of VSWR

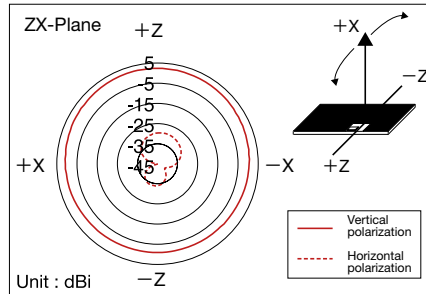

Typical characteristics of radiation pattern (@1.575GHz)

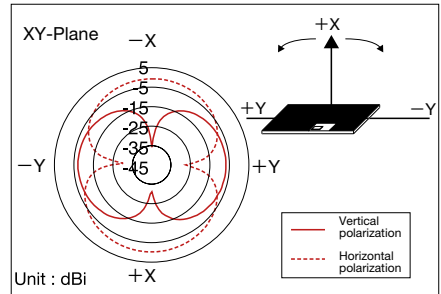

● AF 216M245001

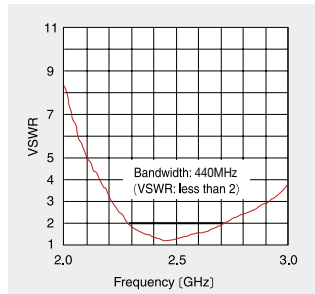

Typical characteristics of VSWR

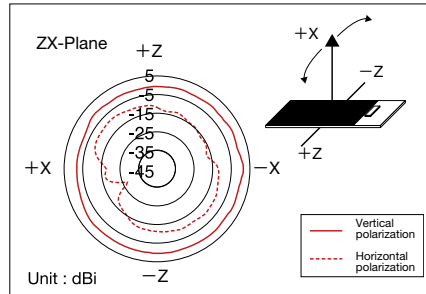

Typical characteristics of radiation pattern (@2.45GHz)

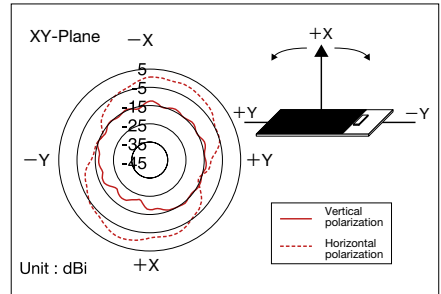

● AH 316M245001

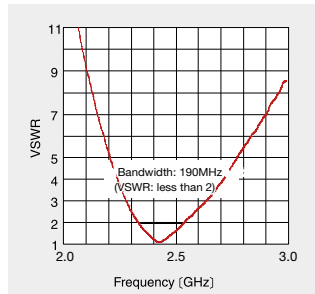

Typical characteristics of VSWR

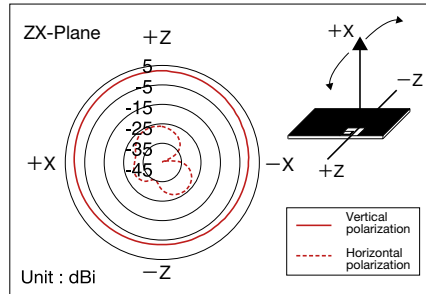

Typical characteristics of radiation pattern (@2.45GHz)

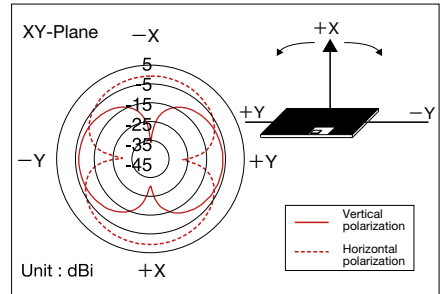

* This catalog contains the typical specification only due to the limitation of space. When you consider purchase of our products, please check our specification. For details of each product (characteristics graph, reliability information, precautions for use, and so on), see our Web site (<http://www.ty-top.com/>) or CD catalogs.

ELECTRICAL CHARACTERISTICS-TYPICAL CHARACTERISTICS

Typical Characteristics on Taiyo Yuden evaluation board

● AH 083F245001

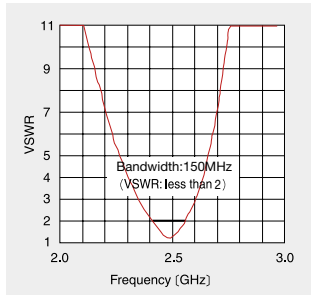

Typical characteristics of VSWR

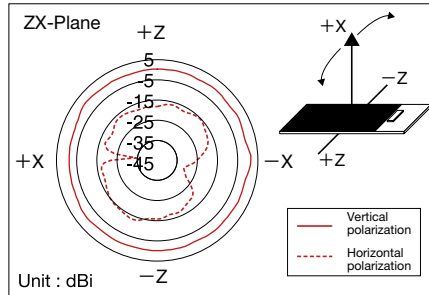

Typical characteristics of radiation pattern (@2.45GHz)

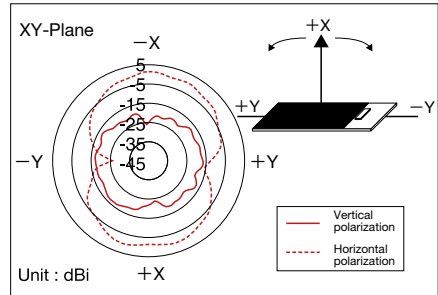

● AH 104F2450S1

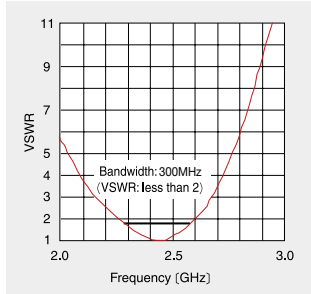

Typical characteristics of VSWR

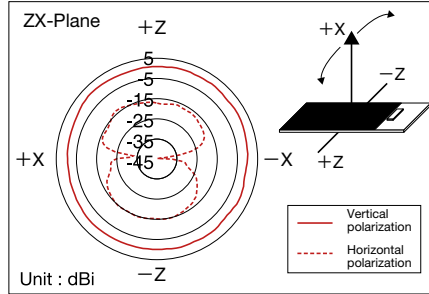

Typical characteristics of radiation pattern (@2.45GHz)

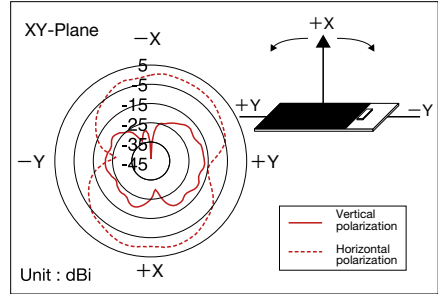

● AH 122F245001

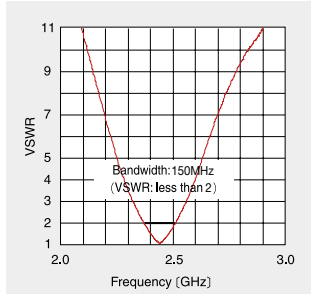

Typical characteristics of VSWR

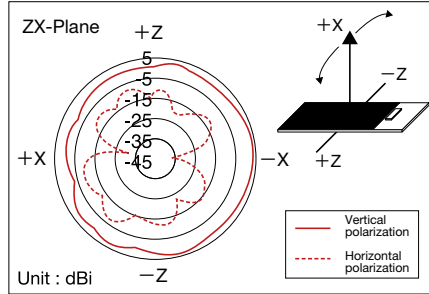

Typical characteristics of radiation pattern (@2.45GHz)

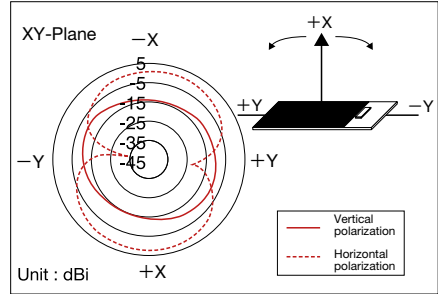

● AH 104N2450D1

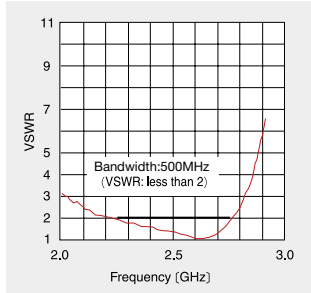

Typical characteristics of VSWR (2GHz band)

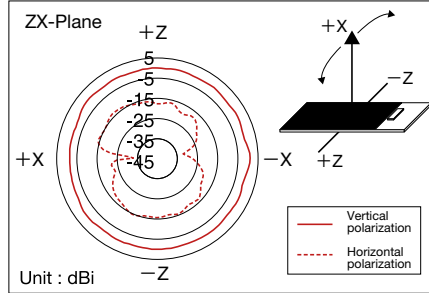

Typical characteristics of radiation pattern (@2.45GHz)

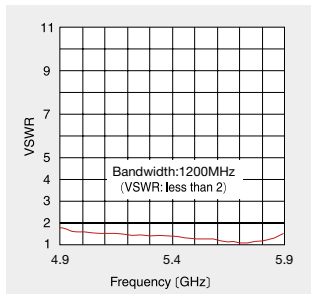
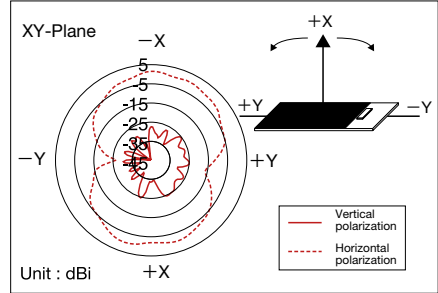

Typical characteristics of VSWR (5GHz band)

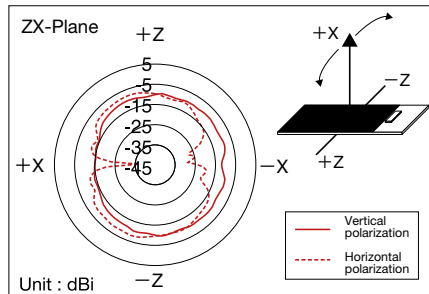

Typical characteristics of radiation pattern (@5.25GHz)

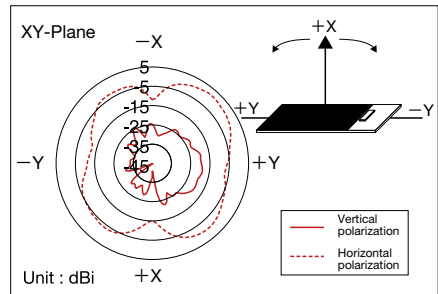

* This catalog contains the typical specification only due to the limitation of space. When you consider purchase of our products, please check our specification. For details of each product (characteristics graph, reliability information, precautions for use, and so on), see our Web site (<http://www.ty-top.com/>) or CD catalogs.

Typical Characteristics on Taiyo Yuden evaluation board

● AH 086M555001

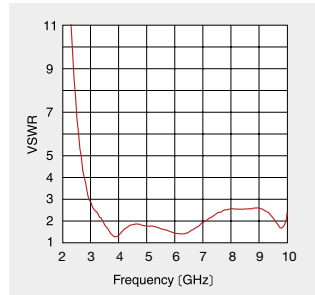

Typical characteristics of VSWR

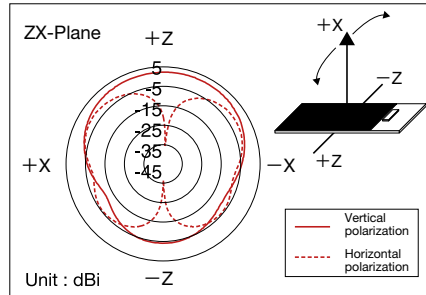

Typical characteristics of radiation pattern (@3.96GHz)

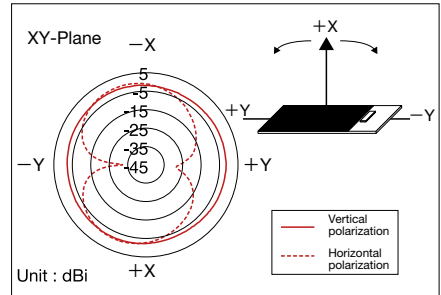

● AH 086M555003

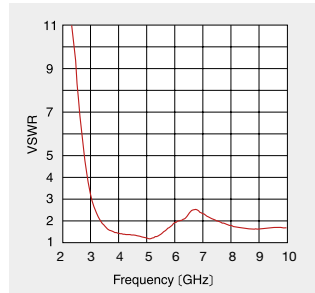

Typical characteristics of VSWR

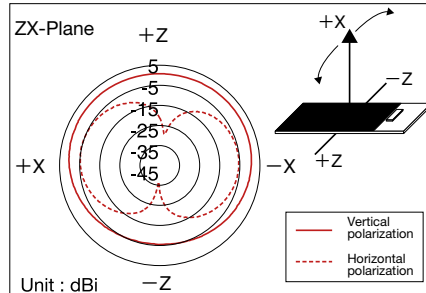

Typical characteristics of radiation pattern (@3.96GHz)

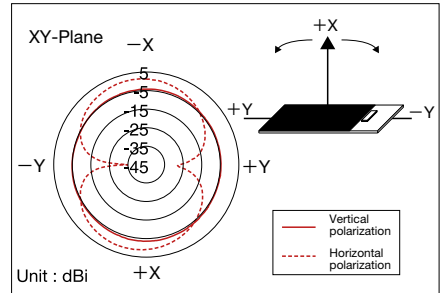

* This catalog contains the typical specification only due to the limitation of space. When you consider purchase of our products, please check our specification. For details of each product (characteristics graph, reliability information, precautions for use, and so on), see our Web site (<http://www.ty-top.com/>) or CD catalogs.

PACKAGING

① Minimum Quantity

Type	Standard Quantity (pcs) Embossed Tape
AF216M, AF816M, AF116M, AH104F, AH122F, AH104N	2000
AH316M	3000
AH083F, AH086M	1000

② Tape Material

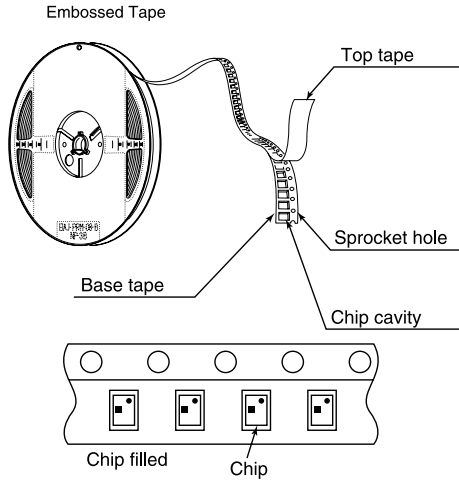

③ Taping Dimensions

● Embossed Tape

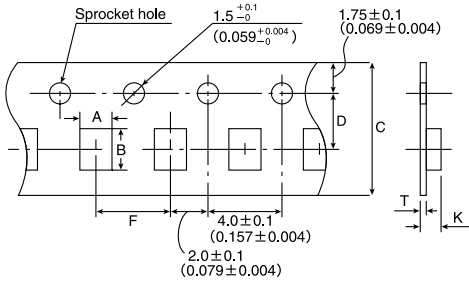

Type	Chip Cavity		Tape Widthness		Insertion Pitch	Tape Thickness MAX.	
	A	B	C	D		K	T
AF216M	1.85 ± 0.2 (0.073 ± 0.008)	2.75 ± 0.2 (0.108 ± 0.008)	8 ± 0.2 (0.315 ± 0.008)	3.5 ± 0.1 (0.138 ± 0.004)	4 ± 0.1 (0.157 ± 0.004)	1.95 (0.077)	0.3 (0.012)
AF816M	1.95 ± 0.2 (0.077 ± 0.008)	8.4 ± 0.2 (0.331 ± 0.008)	16 ± 0.3 (0.630 ± 0.012)	7.5 ± 0.1 (0.296 ± 0.004)	4 ± 0.1 (0.157 ± 0.004)	2.05 (0.081)	0.35 (0.014)
AF116M	1.95 ± 0.2 (0.077 ± 0.008)	11.4 ± 0.2 (0.449 ± 0.008)	24 ± 0.3 (0.945 ± 0.012)	11.5 ± 0.1 (0.453 ± 0.004)	4 ± 0.1 (0.157 ± 0.004)	2.05 (0.081)	0.35 (0.014)
AH316M	1.9 ± 0.2 (0.075 ± 0.008)	3.5 ± 0.2 (0.138 ± 0.008)	8 ± 0.2 (0.315 ± 0.012)	3.5 ± 0.1 (0.138 ± 0.004)	4 ± 0.1 (0.157 ± 0.004)	0.85 (0.033)	0.3 (0.012)
AH083F	3.35 ± 0.2 (0.132 ± 0.008)	8.35 ± 0.2 (0.329 ± 0.008)	16 ± 0.3 (0.630 ± 0.012)	7.5 ± 0.1 (0.295 ± 0.004)	8 ± 0.1 (0.315 ± 0.004)	1.55 (0.061)	0.3 (0.012)
AH104F, AH104N	4.35 ± 0.2 (0.171 ± 0.008)	10.35 ± 0.2 (0.407 ± 0.008)	24 ± 0.3 (0.945 ± 0.012)	11.5 ± 0.1 (0.435 ± 0.004)	8 ± 0.1 (0.315 ± 0.004)	1.55 (0.061)	0.3 (0.012)
AH122F	2.3 ± 0.2 (0.091 ± 0.008)	12.3 ± 0.2 (0.484 ± 0.008)	24 ± 0.3 (0.945 ± 0.012)	11.5 ± 0.1 (0.435 ± 0.004)	4 ± 0.1 (0.157 ± 0.004)	1.45 (0.057)	0.35 (0.014)
AH086M	6.25 ± 0.2 (0.246 ± 0.008)	8.26 ± 0.2 (0.325 ± 0.008)	16 ± 0.3 (0.630 ± 0.012)	7.5 ± 0.1 (0.296 ± 0.004)	12 ± 0.1 (0.473 ± 0.004)	1.3 (0.051)	0.3 (0.012)

Unit : mm (inch)

④ Leader and Blank Portion

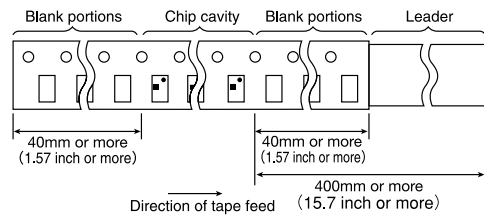

⑤ Reel size

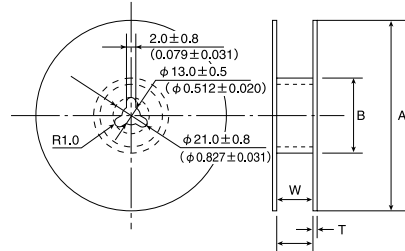

Type	A	B	W	T
AF216M	178 ± 2.0 (7.0 ± 0.08)	50 min. (2.0 min.)	10.0 ± 1.5 (0.394 ± 0.06)	3.0 max. (0.12 max.)
AH316M	178 ± 2.0 (7.0 ± 0.08)	50 min. (2.0 min.)	17.0 ± 1.0 (0.67 ± 0.04)	2.5 max. (0.1 max.)
AF816M	178 ± 2.0 (7.0 ± 0.08)	50 min. (2.0 min.)	17.0 ± 1.0 (0.67 ± 0.04)	2.5 max. (0.1 max.)
AH083F	330 ± 2.0 (13.0 ± 0.08)	100 ± 1.0 (3.94 ± 0.04)	25.5 ± 1.0 (1.0 ± 0.04)	3.0 max. (0.12 max.)
AF116M, AH104F	330 ± 2.0 (13.0 ± 0.08)	100 ± 1.0 (3.94 ± 0.04)	17.0 ± 1.0 (0.67 ± 0.04)	2.5 max. (0.1 max.)
AH122F, AH104N	330 ± 2.0 (13.0 ± 0.08)	100 ± 1.0 (3.94 ± 0.04)	17.0 ± 1.0 (0.67 ± 0.04)	2.5 max. (0.1 max.)

Unit : mm (inch)

⑥ Top Tape Strength

The top tape requires a peel-off force of 0.1~0.7N in the direction of the arrow as illustrated below.

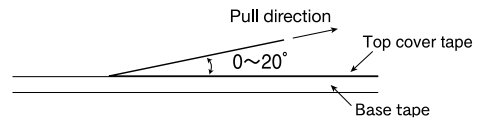

* This catalog contains the typical specification only due to the limitation of space. When you consider purchase of our products, please check our specification. For details of each product (characteristics graph, reliability information, precautions for use, and so on), see our Web site (<http://www.ty-top.com/>) or CD catalogs.

RELIABILITY DATA

1. Operating Temperature Range	
Specified Value	-20~+80°C
2. Storage Temperature Range	
Specified Value	-40~+85°C
【Test Methods and Remarks】 ※with being taped, -20~+35°C	
3. Solderability	
Specified Value	At least 90% of Terminal surface immersed is covered by new solder.
【Test Methods and Remarks】 Solder temperature : 230±5°C Duration : 3±1 sec. Preconditioning : Preheating at 150°C after immersion into flux.	
4. Thermal Shock	
Specified Value	Shall satisfy required VSWR value of individual specifications for each item.
【Test Methods and Remarks】 1 hour of recovery after 10 times of 30min.immersion alternately at -40°C and 85°C of temperature, followed by evaluating electrical characteristics.	
5. High Temperature Storage Test	
Specified Value	Shall satisfy required VSWR value of individual specifications for each item.
【Test Methods and Remarks】 1 hour of recovery under standard condition after 96 hours recovery with 85°C of temperature, followed by evaluating electrical characteristics.	
6. Low Temperature Storage Test	
Specified Value	Shall satisfy required VSWR value of individual specifications for each item.
【Test Methods and Remarks】 1 hour of recovery under standard condition after 96 hours recovery with -40°C of temperature, followed by evaluating electrical characteristics.	
7. Humidity Storage Test	
Specified Value	Shall satisfy required VSWR value of individual specifications for each item.
【Test Methods and Remarks】 1 hour of recovery under standard condition after 96 hours recovery with 60°C of temperature, 90~95% relative humidity followed by evaluating electrical characteristics.	
8. Resistance to Reflow	
Specified Value	Shall satisfy required VSWR value of individual specifications for each item.
【Test Methods and Remarks】 Two times of reflow soldering by recommended profile attached, followed by evaluating electrical characteristics.	

* This catalog contains the typical specification only due to the limitation of space. When you consider purchase of our products, please check our specification.
For details of each product (characteristics graph, reliability information, precautions for use, and so on), see our Web site (<http://www.ty-top.com/>) or CD catalogs.

PRECAUTIONS

1. PCB Design

Precautions ◆ Land pattern design
Please do not arrange the surface and inside layer pattern near the antenna mounting area.

◆ Land pattern design
Land pattern dimension examples and recommended antenna land pattern

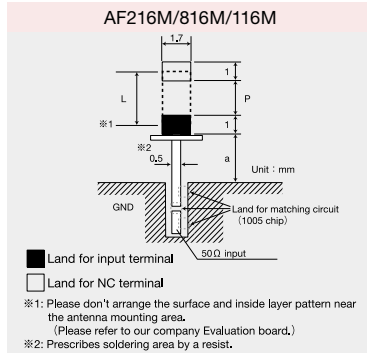

Type	Dimensions		
	L	P	a
AF216M	2.5	1.5	3
AF816M	8	7	5
AF116M	11	10	3

Unit : mm

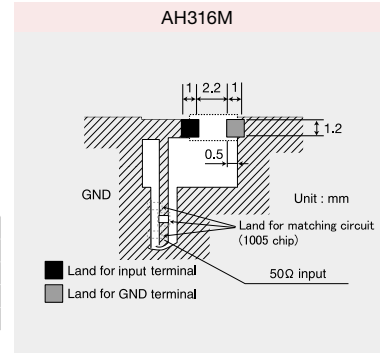

Technical Considerations

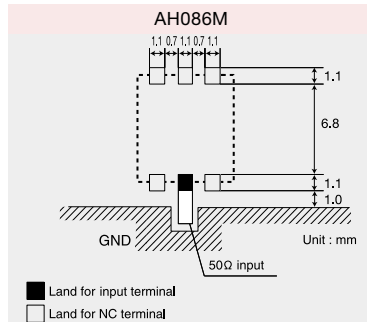
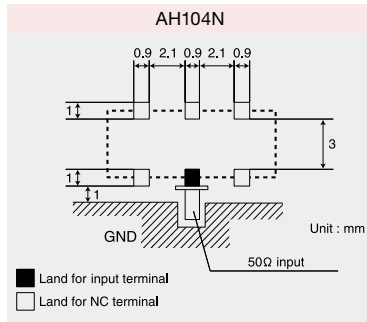
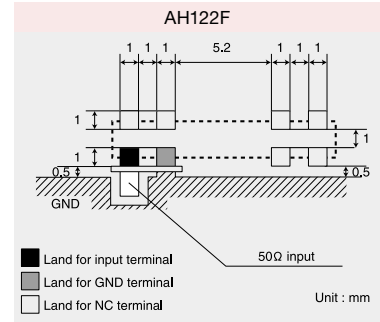
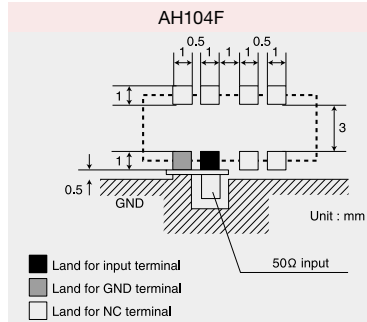
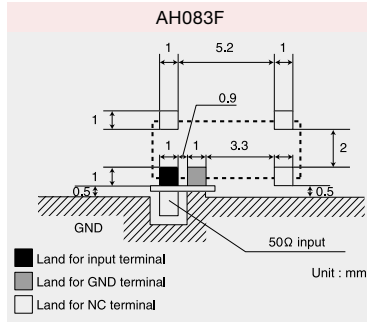

2. Soldering

◆ Conditions of Reflow soldering (for reference)

Technical Considerations

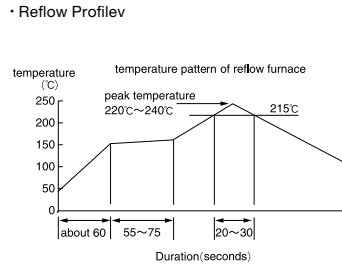
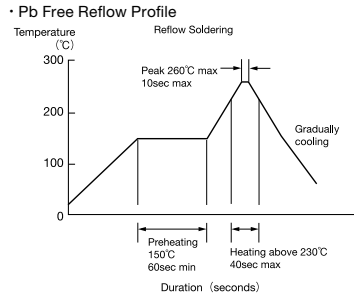

※ Components should be preheated to within 100 to 130°C from soldering temperature.
※ Assured to be reflow soldering for 2 times.

Note : The above profiles are the maximum allowable soldering condition, therefore these profiles are not always recommended.

3. Storage Conditions

◆ Storage conditions

Precautions

1. The Products should not be used in the following environments :

- exposure to special gases such as (C12, NH3, SOx, NOx)
- exposure to volatile gas or inflammable gas
- exposure to a lot of dust
- exposure to water or condensation
- exposure to direct sunlight or freezing

2. The Products should be kept in the following conditions :

- Temperature : -10~+40°C
- Humidity : 15~85%RH

3. The products should be used within 6 months after delivery. In case of storage over 6 months, solderability shall be checked before actual usage.

◆ Please contact our offices for further details of specifications.
All of the standard values listed here are subject to change without notice due to technical improvements.
Therefore, please check the specifications carefully before use.

* This catalog contains the typical specification only due to the limitation of space. When you consider purchase of our products, please check our specification.
For details of each product (characteristics graph, reliability information, precautions for use, and so on), see our Web site (<http://www.ty-top.com/>) or CD catalogs.