

SGM803 SGM809 SGM810

Microprocessor Supervisory Circuit in 3-Pin SOT23

GENERAL DESCRIPTION

The SGM803/SGM809/SGM810 supervisory circuits monitor the power supply voltage in microprocessor and digital systems. They provide a reset output during power-up, power-down and brownout conditions. On power-up, an internal timer holds reset asserted for 240 ms. This holds the microprocessor in a reset state until conditions have stabilized. The $\overline{\text{RESET}}$ output remains operational with V_{CC} as low as 1 V. The SGM803/SGM809 provides an active low reset signal ($\overline{\text{RESET}}$) while the SGM810 provides an active high signal (RESET) output. The SGM809/SGM810 have push-pull outputs, whereas the SGM803 has an open-drain output, which requires an external pull-up resistor.

Seven reset threshold voltage options are available suitable for monitoring 2.5V, 3V, 3.3V, and 5V supply voltages.

The reset comparator features built-in glitch immunity, making it immune to fast transients on V_{CC} .

The low supply current of typically $17\mu\text{A}$ makes the SGM803/SGM809/SGM810 ideal for use in portable, battery operated equipment. They are available in the 3-pin SOT23 package.

APPLICATIONS

Microprocessor Systems
Controllers
Intelligent Instruments
Automotive Systems
Safety Systems
Portable Instruments

TYPICAL OPERATION CIRCUIT

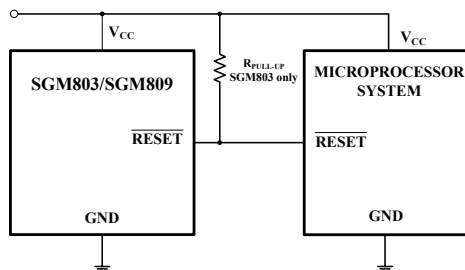

FEATURES

- Precision Voltage Monitor: 2.5V, 3 V, 3.3 V, 5 V Options
- Superior Upgrade for MAX803/MAX809/MAX810 and SGM803/SGM809/SGM810
- Fully Specified over Temperature
- Low Power Consumption ($17\mu\text{A Typ}$)
- Reset Assertion Down to 1 V V_{CC}
- 160 ms Min Power-On Reset
 - Open-Drain $\overline{\text{RESET}}$ Output (SGM803)
 - Push-Pull $\overline{\text{RESET}}$ Output (SGM809)
 - Push-Pull RESET Output (SGM810)
- Compact 3-Pin SOT23 Package

PIN CONFIGURATIONS (TOP VIEW)

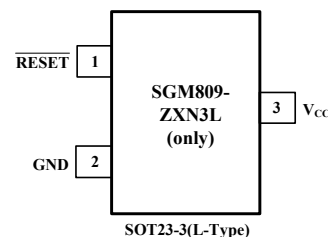
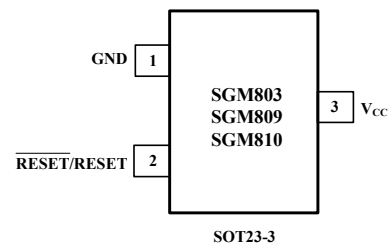

ORDERING INFORMATION

MODEL	RESET THRESHOLD (V)	SPECIFIED TEMPERATURE RANGE	ORDERING NUMBER	PACKAGE MARKING	PACKAGE OPTION
SGM803	4.63	- 40°C to +125°C	SGM803-LXN3	803L	Tape and Reel, 3000
	4.38	- 40°C to +125°C	SGM803-MXN3	803M	Tape and Reel, 3000
	3.08	- 40°C to +125°C	SGM803-TXN3	803T	Tape and Reel, 3000
	2.93	- 40°C to +125°C	SGM803-SXN3	803S	Tape and Reel, 3000
	2.63	- 40°C to +125°C	SGM803-RXN3	803R	Tape and Reel, 3000
	2.32	- 40°C to +125°C	SGM803-ZXN3	803Z	Tape and Reel, 3000
SGM809	4.63	- 40°C to +125°C	SGM809-LXN3	809L	Tape and Reel, 3000
	4.38	- 40°C to +125°C	SGM809-MXN3	809M	Tape and Reel, 3000
	4.00	- 40°C to +125°C	SGM809-JXN3	809J	Tape and Reel, 3000
	3.08	- 40°C to +125°C	SGM809-TXN3	809T	Tape and Reel, 3000
	2.93	- 40°C to +125°C	SGM809-SXN3	809S	Tape and Reel, 3000
	2.63	- 40°C to +125°C	SGM809-RXN3	809R	Tape and Reel, 3000
	2.32	- 40°C to +125°C	SGM809-ZXN3	809Z	Tape and Reel, 3000
	2.32	- 40°C to +125°C	SGM809-ZXN3L	809ZL	Tape and Reel, 3000
SGM810	4.63	- 40°C to +125°C	SGM810-LXN3	810L	Tape and Reel, 3000
	4.38	- 40°C to +125°C	SGM810-MXN3	810M	Tape and Reel, 3000
	4.00	- 40°C to +125°C	SGM810-JXN3	810J	Tape and Reel, 3000
	3.08	- 40°C to +125°C	SGM810-TXN3	810T	Tape and Reel, 3000
	2.93	- 40°C to +125°C	SGM810-SXN3	810S	Tape and Reel, 3000
	2.63	- 40°C to +125°C	SGM810-RXN3	810R	Tape and Reel, 3000
	2.32	- 40°C to +125°C	SGM810-ZXN3	810Z	Tape and Reel, 3000

ABSOLUTE MAXIMUM RATINGS

(Typical values are at $T_A = 25^\circ\text{C}$, unless otherwise noted.)

V_{CC}	-0.3 V to +6 V
RESET, $\overline{\text{RESET}}$	-0.3 V to $V_{CC} + 0.3$ V
Input Current, V_{CC}	20 mA
Output Current, RESET, $\overline{\text{RESET}}$	20 mA
Rate of Rise, V_{CC}	100 V/ μs
Power Dissipation, P_D @ $T_A = 25^\circ\text{C}$	
SOT23-3.....	0.4W
Package Thermal Resistance	

SOT23-3, θ_{JA}	250 $^\circ\text{C}/\text{W}$
Operating Temperature Range.....	- 40 $^\circ\text{C}$ to +125 $^\circ\text{C}$
Junction Temperature.....	+150 $^\circ\text{C}$
Storage Temperature.....	- 65 $^\circ\text{C}$ to +150 $^\circ\text{C}$
Lead Temperature (soldering, 10s).....	+260 $^\circ\text{C}$
ESD Susceptibility	
HBM.....	4000V
MM.....	400V

Stresses beyond those listed under “Absolute Maximum Ratings” may cause permanent damage to the device. These are stress ratings only, and functional operation of the device at these or any other conditions beyond those indicated in the operational sections of the specifications is not implied. Exposure to absolute maximum rating conditions for extended periods may affect device reliability.

PIN DESCRIPTION

NAME	Pin Number				FUNCTION
	SGM803	SGM809	SGM809-ZXN3L	SGM810	
GND	1	1	2	1	Ground
$\overline{\text{RESET}}$	2	2	1	—	Active Low reset. $\overline{\text{RESET}}$ remains low while V_{CC} is below the reset threshold, and remains low for 240 ms (typ) after V_{CC} rises above the reset threshold.
RESET	—	—	—	2	Active High reset. RESET remains high while V_{CC} is below the reset threshold, and remains high for 240 ms (typ) after V_{CC} rises above the reset threshold.
V_{CC}	3	3	3	3	Power supply voltage that is monitored.

ELECTRICAL CHARACTERISTICS

(V_{CC} Typ = 5 V for L/M/J Models, 3.3 V for T/S Models, 3 V for R Models, 2.5 V for Z Models; unless otherwise noted.)

PARAMETER	CONDITIONS	MIN	TYP	MAX	UNITS
SUPPLY					
Voltage	T _A = 0°C to 70°C	1.0		5.5	V
	T _A = - 40°C to +125°C	1.2		5.5	V
Current	V _{CC} < 5.5 V, SGM8_L/M/J, T _A = 25°C		20	30	μA
	V _{CC} < 5.5 V, SGM8_L/M/J, T _A = - 40°C to +125°C			50	μA
	V _{CC} < 3.6 V, SGM8_R/S/T/Z, T _A = 25°C		17	25	μA
	V _{CC} < 3.6 V, SGM8_R/S/T/Z, T _A = - 40°C to +125°C			45	μA
RESET VOLTAGE THRESHOLD					
SGM8_L	T _A = 25°C	4.537	4.63	4.723	V
	T _A = - 40°C to +125°C	4.40		4.86	V
SGM8_M	T _A = 25°C	4.292	4.38	4.468	V
	T _A = - 40°C to +125°C	4.16		4.56	V
SGM809J/SGM810J	T _A = 25°C	3.92	4.00	4.08	V
	T _A = - 40°C to +125°C	3.8		4.2	V
SGM8_T	T _A = 25°C	3.003	3.08	3.157	V
	T _A = - 40°C to +125°C	2.92		3.23	V
SGM8_S	T _A = 25°C	2.857	2.93	3.003	V
	T _A = - 40°C to +125°C	2.78		3.08	V
SGM8_R	T _A = 25°C	2.564	2.63	2.696	V
	T _A = - 40°C to +125°C	2.50		2.76	V
SGM8_Z	T _A = 25°C	2.262	2.32	2.378	V
	T _A = - 40°C to +125°C	2.22		2.42	V
RESET THRESHOLD Temperature Coefficient			30		ppm/°C
V _{CC} to RESET/ $\overline{\text{RESET}}$ Delay	V _{CC} = V _{TH} (V _{TH} -100 mV)		20		μs
Reset Active Timeout Period	T _A = - 40°C to +85°C	160	240	560	ms
	T _A = - 40°C to +125°C	100		840	ms
RESET/$\overline{\text{RESET}}$ OUTPUT VOLTAGE					
Low (SGM803R/S/T/Z) Low (SGM809R/S/T/Z)	V _{CC} = V _{TH(MIN)} , I _{SINK} = 1.2mA			0.3	V
Low (SGM803L/M/J) Low (SGM809L/M/J)	V _{CC} = V _{TH(MIN)} , I _{SINK} = 3.2mA			0.4	V
Low (SGM803R/S/T/L/M/J/Z) Low (SGM809R/S/T/L/M/J/Z)	V _{CC} > 1.0 V, I _{SINK} = 50μA			0.3	V
High (SGM809R/S/T/Z)	V _{CC} > V _{TH(MAX)} , I _{SOURCE} = 500μA	0.8×V _{CC}			V
High (SGM809L/M/J)	V _{CC} > V _{TH(MAX)} , I _{SOURCE} = 800μA	V _{CC} - 1.5			V
Low (SGM810R/S/T/Z)	V _{CC} = V _{TH(MAX)} , I _{SINK} = 1.2mA			0.3	V
Low (SGM810L/M/J)	V _{CC} = V _{TH(MAX)} , I _{SINK} = 3.2mA			0.4	V
High (SGM810 R/S/T/L/M/J)	1.8 V < V _{CC} < V _{TH(MIN)} , I _{SOURCE} = 150μA	0.8×V _{CC}			V
$\overline{\text{RESET}}$ Open-Drain Output Leakage Current (SGM803)	V _{CC} > V _{TH} , reset de-asserted			1	μA

Specifications subject to change without notice.

TYPICAL PERFORMANCE CHARACTERISTICS

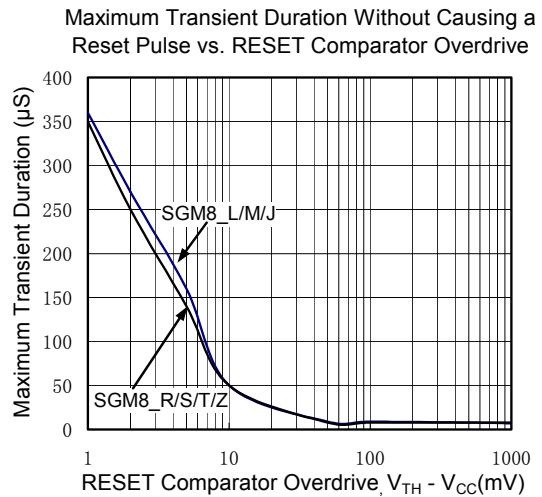
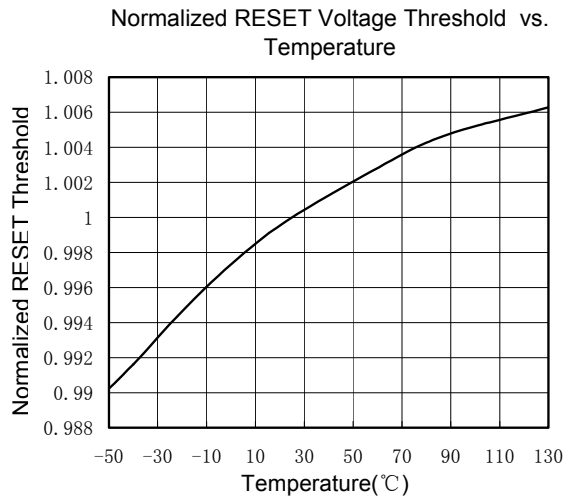
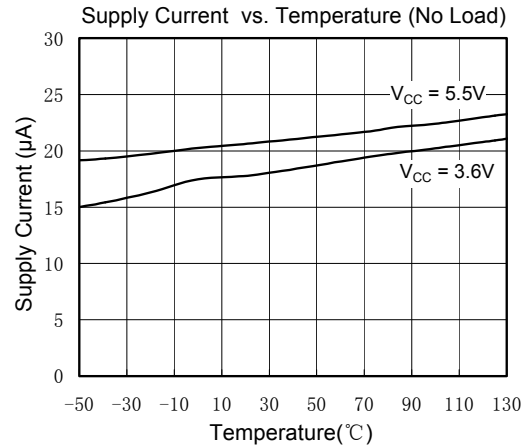
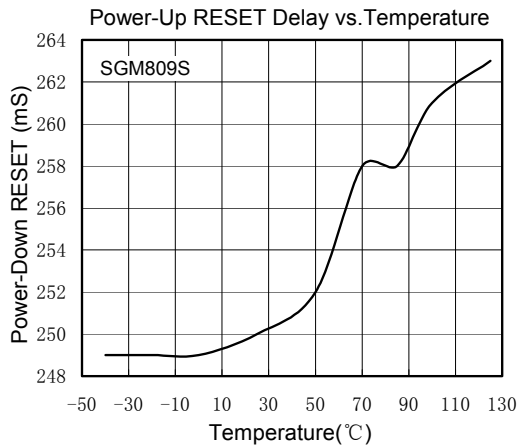
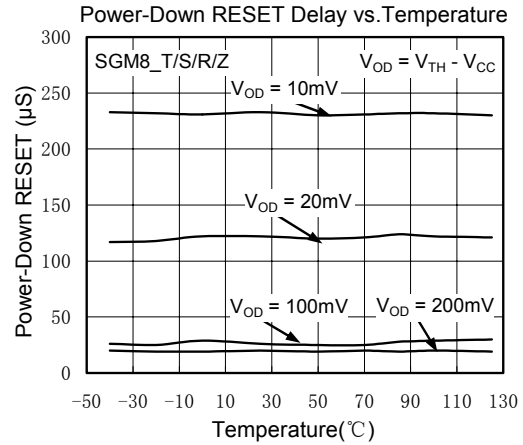
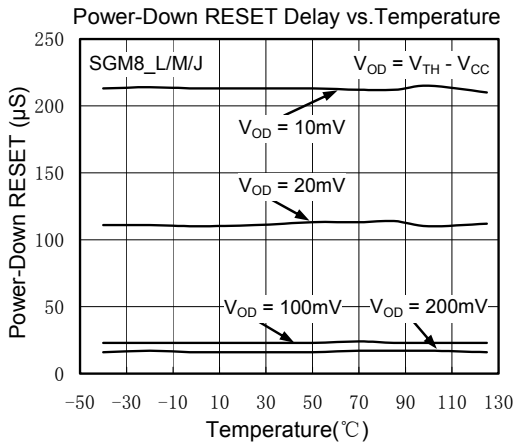

TYPICAL PERFORMANCE CHARACTERISTICS

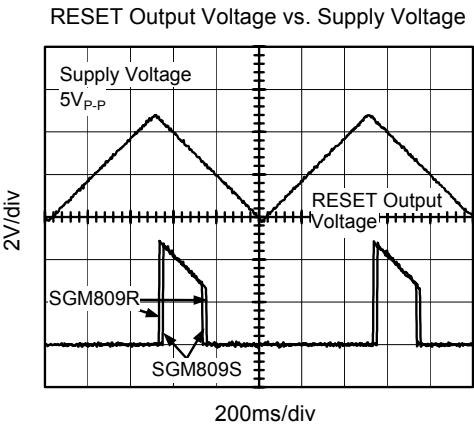

APPLICATION NOTES

BENEFITS OF AN ACCURATE RESET THRESHOLD

In other microprocessor supervisory circuits, tolerances in supply voltages lead to an overall increase in reset tolerance levels due to the deterioration of the microprocessor reset circuit's power supply. The possibility of a malfunction during a power failure is greatly reduced because the SGM803/SGM809/SGM810 series can operate effectively even when there are large degradations of the supply voltages. Another advantage of the SGM803/SGM809/SGM810 series is its very accurate internal voltage reference circuit. These benefits combine to produce an exceptionally reliable voltage monitor circuit.

INTERFACING TO MICROPROCESSORS WITH MULTIPLE INTERRUPTS

In a number of cases, it is necessary to interface many interrupts from different devices (for example, thermal, altitude, and velocity sensors). The SGM803/SGM809/SGM810 can easily be integrated into existing interrupt-handling circuits, as shown in Figure 1, or can be used as a standalone device.

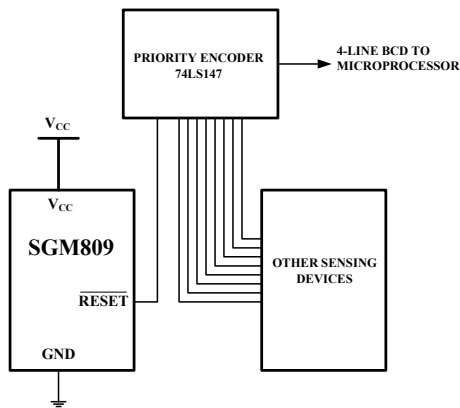

Figure 1. Interfacing to Microprocessors with Multiple Interrupts

INTERFACING TO OTHER DEVICES' OUTPUT

The SGM803/SGM809/SGM810 series is designed to integrate with as many devices as possible and, therefore, has a standard output dependent on V_{CC} . This enables the parts to be used in both 3 V and 5 V, or any nominal voltage within the minimum and maximum specifications for V_{CC} . This design simplifies interfacing this device to other devices.

ENSURING A VALID RESET OUTPUT DOWN TO $V_{CC} = 0\text{ V}$

When V_{CC} falls below 1.0 V, the SGM803/SGM809 \overline{RESET} no longer sinks current. A high impedance CMOS logic input connected to \overline{RESET} may, therefore, drift to undetermined logic levels. To eliminate this problem, a $100\text{k}\Omega$ resistor should be connected from \overline{RESET} to ground.

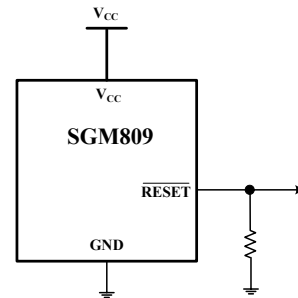
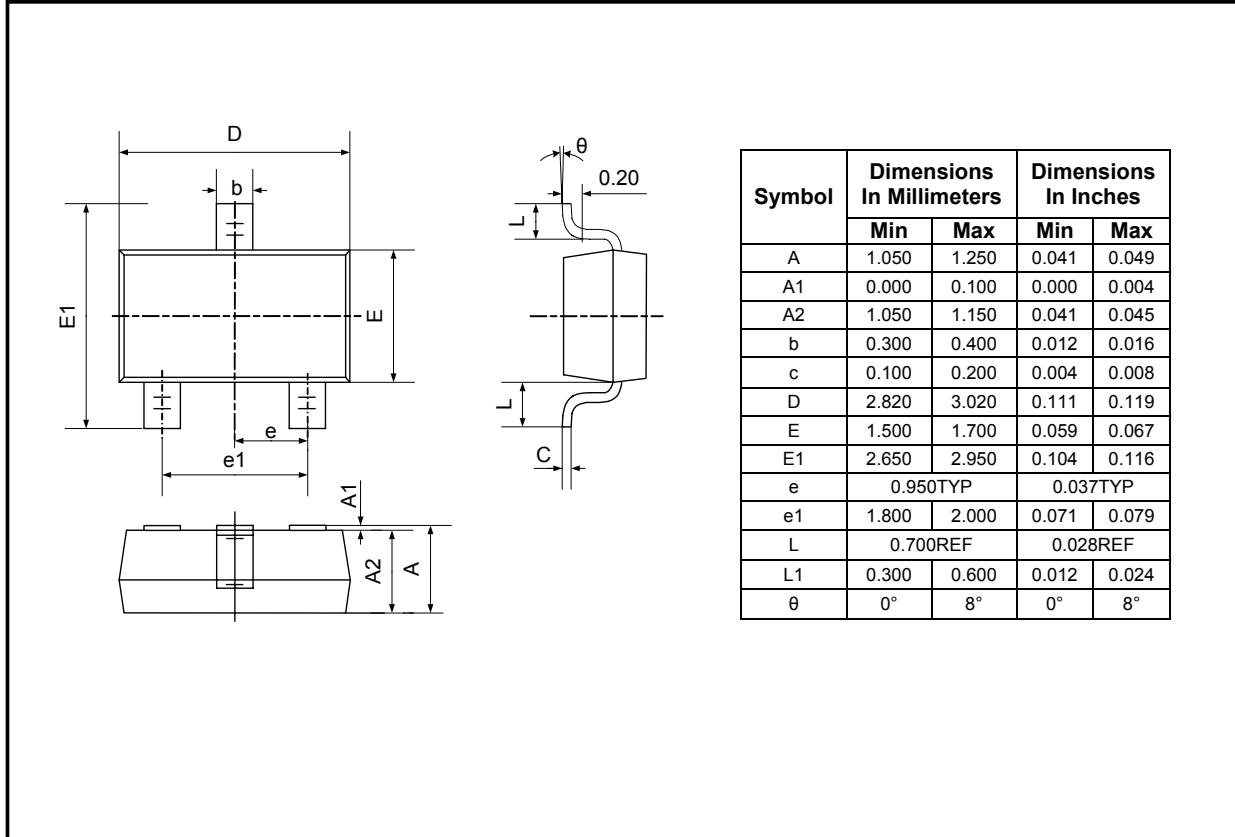

Figure 2. Ensuring a Valid Reset Output Down to $V_{CC} = 0\text{ V}$

PACKAGE OUTLINE DIMENSIONS

SOT23-3



REVISION HISTORY

Location	Page
11/06— Data Sheet changed from REV. A to REV. B	
Changes to ABSOLUTE MAXIMUM RATINGS	3

Shengbang Microelectronics Co, Ltd

Unit 3, ChuangYe Plaza
No.5, TaiHu Northern Street, YingBin Road Centralized Industrial Park
Harbin Development Zone
Harbin, HeiLongJiang 150078
P.R. China
Tel.: 86-451-84348461
Fax: 86-451-84308461
www.sg-micro.com