

GT3 Series

<GT3, GT3B, GT3TK, and GT3TKW>

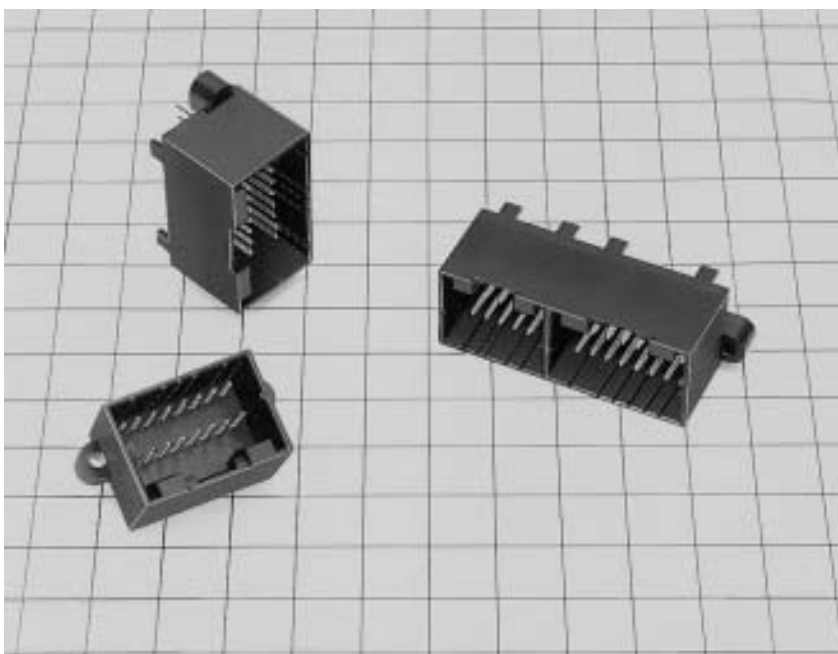

■ Features

- Available in a low-profile (GT3) and a standard (GT3B) type.
- Split type uses a mounting screw hole diameter of 2.6 mm.
- Tab width is size 040.

M Connectors

● Printed Circuit Board mounting type

16 Pos.

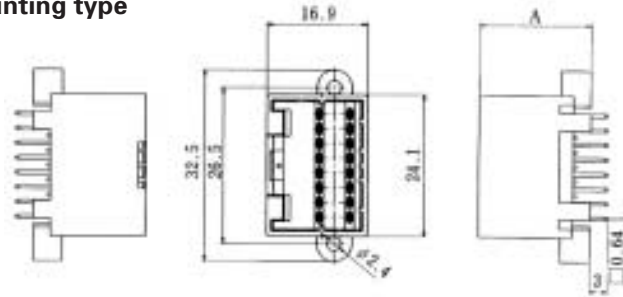

◆ Recommended Board Mounting Pattern

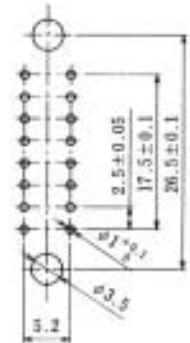

Part Number	CL No.	A Dimension
GT3-16DP-2.5DSA	753-0001-6	17
GT3B-16DP-2.5DSA	753-0003-1	19

Item	Material	Finish
Pin header	PBT	Color: Black
M terminal	Brass	Tin plating

Note: This product is a integral molding design.

20 Pos.

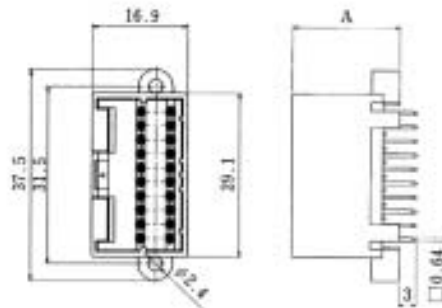

◆ Recommended Board Mounting Pattern

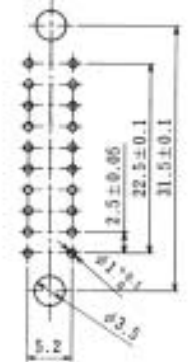

Part Number	CL No.	A Dimension
GT3-20DP-2.5DSA	753-0002-9	17
GT3B-20DP-2.5DSA	753-0004-4	19

Item	Material	Finish
Pin header	PBT	Color: Black
M terminal	Brass	Tin plating

Note: This product is a integral molding design.

● Split Type

12 Pos. + 16 Pos.

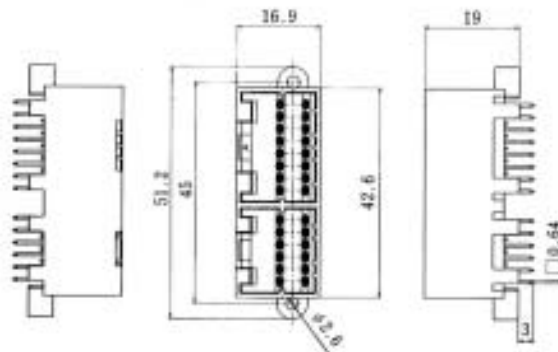

◆ Recommended Board Mounting Pattern

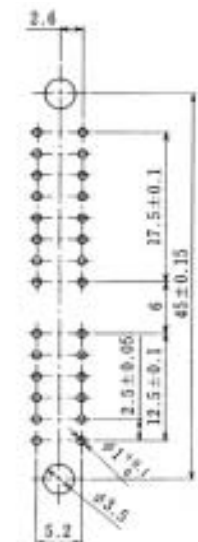

Part Number	CL No.	A Dimension
GT3B-12/16DP-2.5DSA	753-0005-7	17
		19

Item	Material	Finish
Pin header	PBT	Color: Black
M terminal	Brass	Tin plating

128 Note: This product is a integral molding design.

GT3TK Series

● Printed Circuit Board mounting type

8-Pos. Right Angle

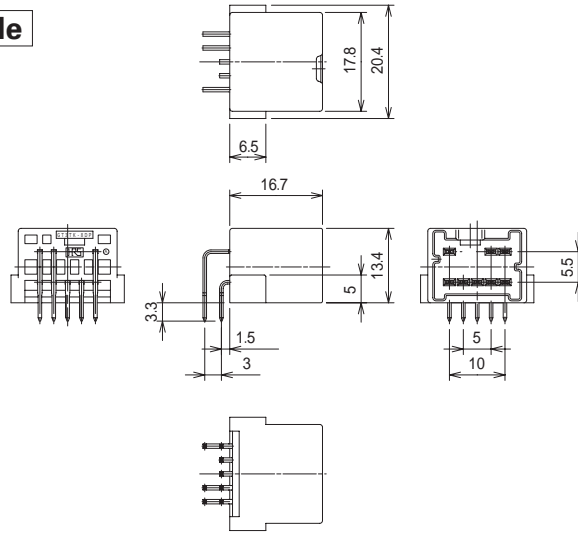
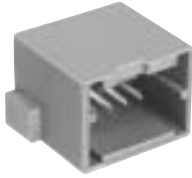

◆ Recommended Board Mounting Pattern

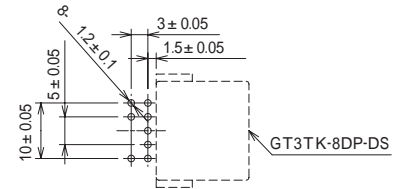

Part Number	CL No.	Material	Finish	Packaging
GT3TK-8DP-DS	753-0007-2	Brass (Terminal) PBT (Housing)	Tin plating Color: Brown	1

8-Pos. Straight

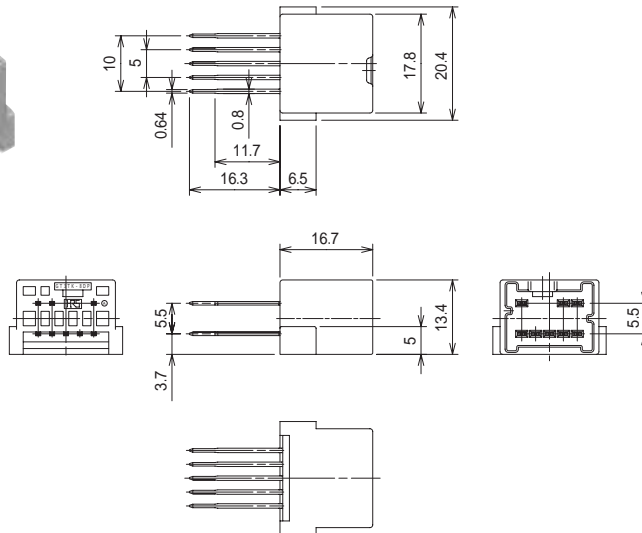
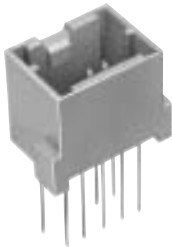

◆ Recommended Board Mounting Pattern

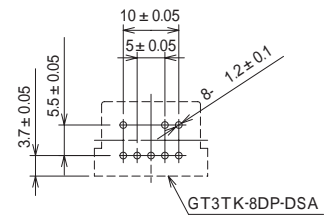

Part Number	CL No.	Material	Finish	Packaging
GT3TK-8DP-DSA	753-0018-9	Brass (Terminal) PBT (Housing)	Tin plating Color: Brown	1

12-Pos. Right Angle

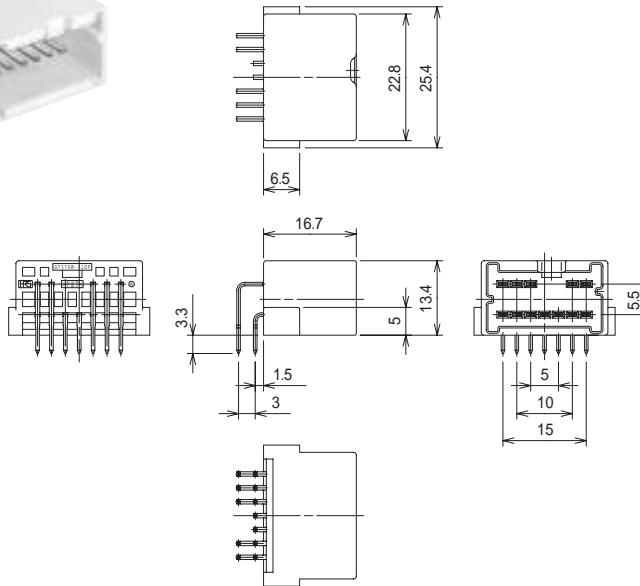

Recommended Board Mounting Pattern

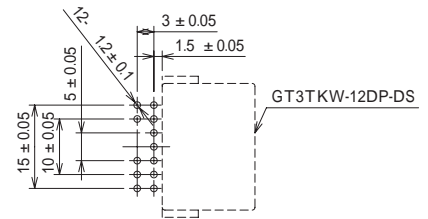

Part Number	CL No.	Material	Finish	Packaging
GT3TKW-12DP-DS	753-0010-7	Brass (Terminal)	Tin plating	1
		PBT (Housing)	Color: Natural	

12-Pos. Straight

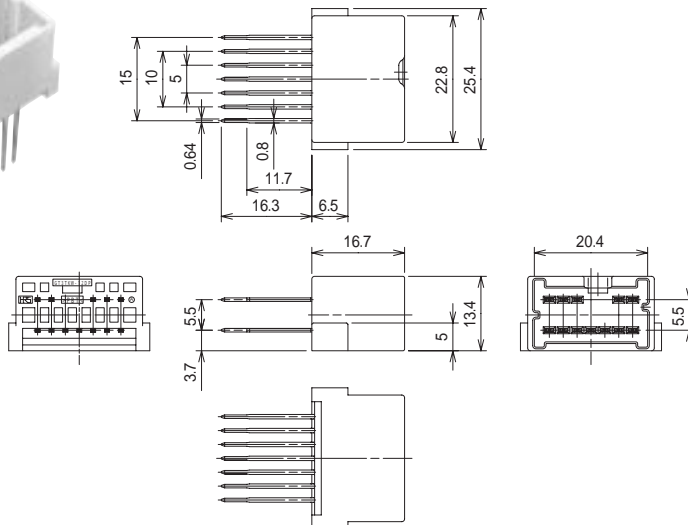

Recommended Board Mounting Pattern

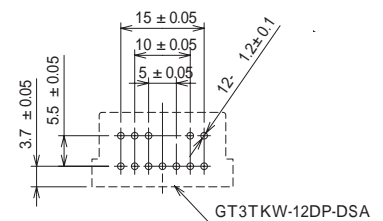

Part Number	CL No.	Material	Finish	Packaging
GT3TKW-12DP-DSA	753-0015-0	Brass (Terminal)	Tin plating	1
		PBT (Housing)	Color: Natural	

16-Pos. Right Angle

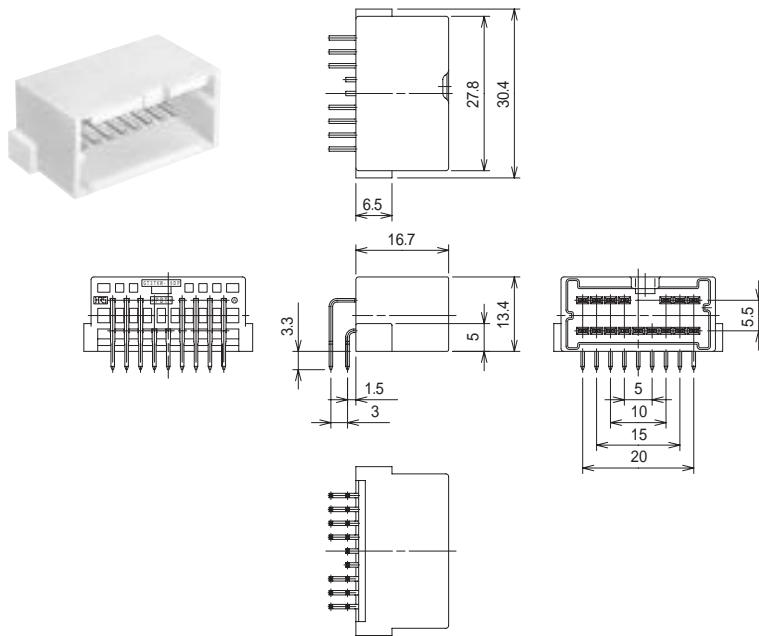

◆ Recommended Board Mounting Pattern

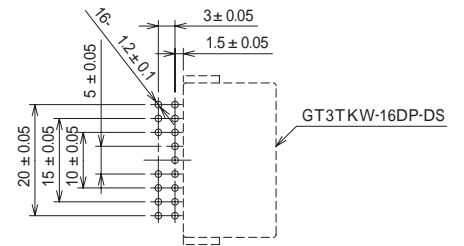

Part Number	CL No.	Material	Finish	Packaging
GT3TKW-16DP-DS	753-0011-0	Brass (Terminal) PBT (Housing)	Tin plating Color: Natural	1

16-Pos. Straight

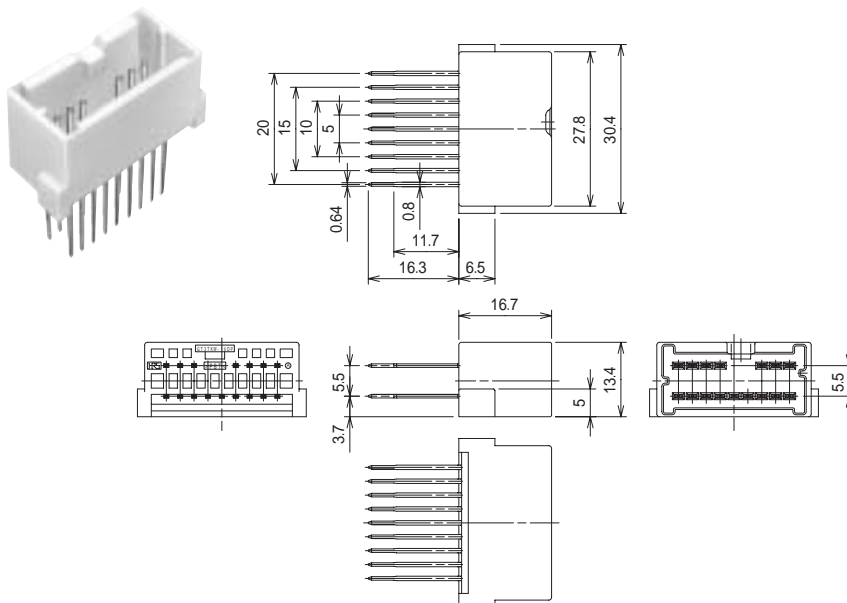

◆ Recommended Board Mounting Pattern

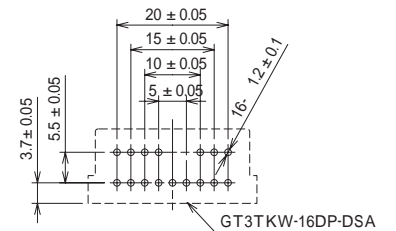

Part Number	CL No.	Material	Finish	Packaging
GT3TKW-16DP-DSA	753-0012-2	Brass (Terminal) PBT (Housing)	Tin plating Color: Natural	1

36-Pos. Straight

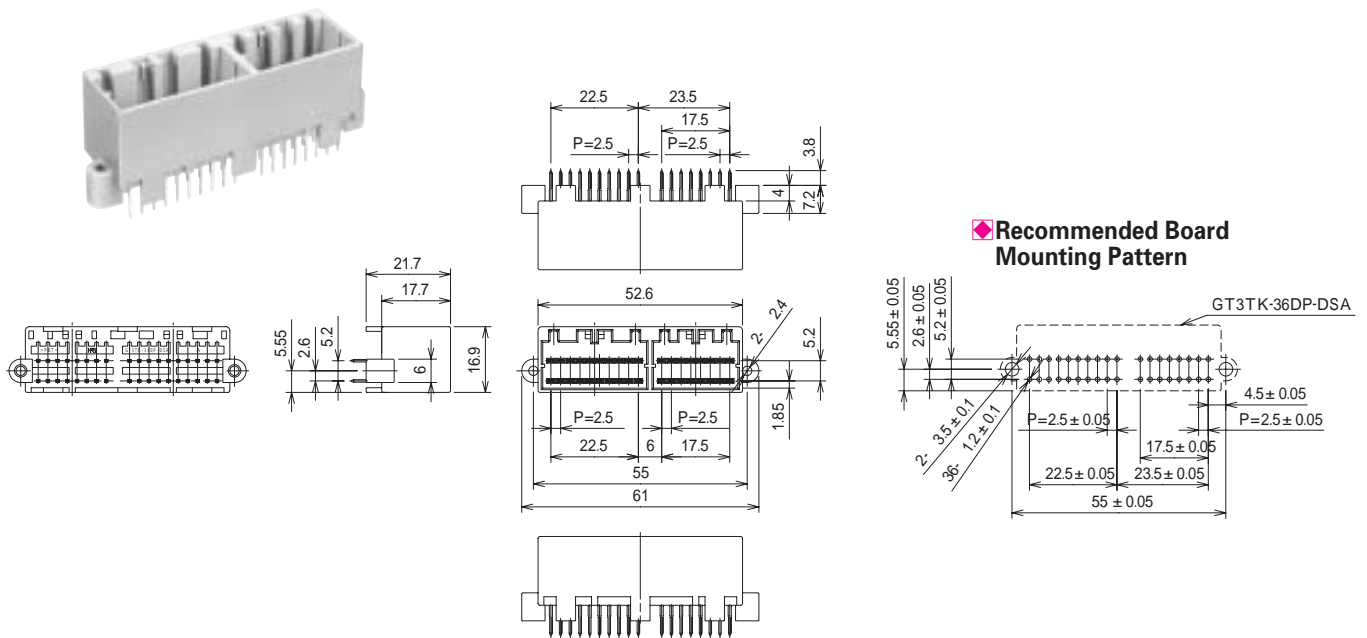

Part Number	CL No.	Material	Finish	Packaging
GT3TK-36DP-DSA	753-0017-6	Brass (Terminal)	Tin plating	1
		PBT (Housing)	Color: Light gray	

Note: Use mounting screws of M3 with nominal diameter 3L-8.

48-Pos. Right Angle

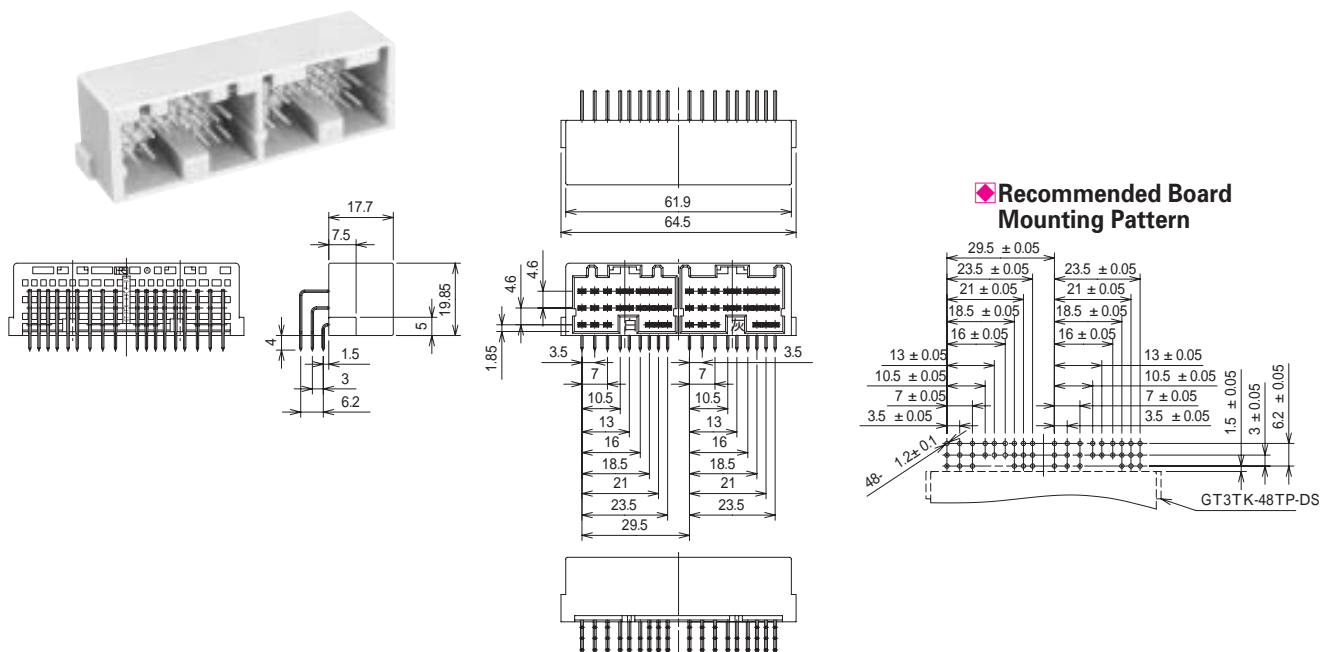

Part Number	CL No.	Material	Finish	Packaging
GT3TK-48TP-DS	753-0008-5	Brass (Terminal)	Tin plating	1
		PBT (Housing)	Color: Light gray	