

# Power Switch 16A 250V AC Qualified Type

SDDJF Series

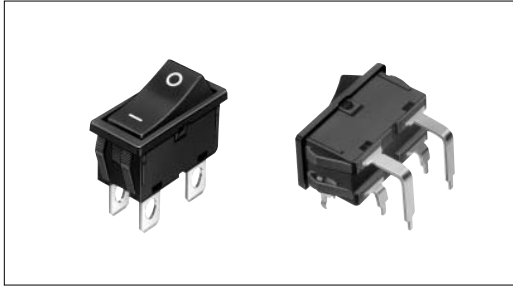

Low-profile and large capacity type suitable for copiers and printers.



## Ratings and Safety Standards

Items	Specifications
UL CSA	16A 250V AC
SEMKO	16( 6 )250 ~
VDE	16( 6 )250 ~
BS	16( 6 )250 ~
Ratings satisfying local electrical appliance and material safety law	125V 16A≠

Detector

Push

Slide

Rotary

Encoders

**Power**

Dual-in-line  
Package Type

TACT Switch™

Custom-  
Products

## Product Line

Circuit arrangement	Travel (mm)	Operating force	Mounting method	Terminal configuration	Marking (Knob)	Minimum order unit (pcs.)	Product No.	Drawing No.
DPST	5.2	6 ± 3N	Snap-in	Lead	mark	1,500	SDDJF30100	1
					IO mark		SDDJF30200	
		3 ± 2N		Right angle	mark	1,000	SDDJF31000	2
					IO mark		SDDJF31100	

## Dimensions

Unit:mm

No.	Configuration (ON position)
1	<p><b>Lead</b></p>
2	<p><b>Right angle</b></p>

## Circuit Diagram

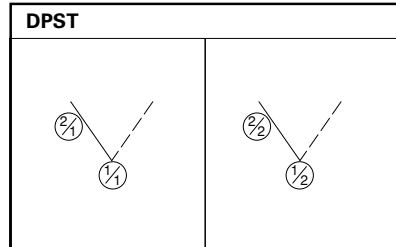

Push  
Type

**Rocker  
Type**

Slide  
Type

Rotary  
Type

## PC board mounting hole dimensions

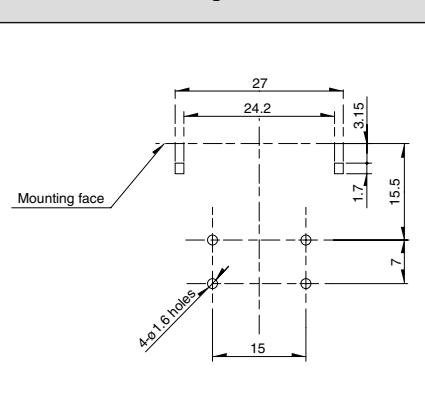

## Notes

- The lead terminals are also used as faston terminals #250( Use a positive lock connector type ).
- Please place purchase orders per minimum order unit(integer).

**■ Mounting Hole Dimensions**

Square-shaped Hole Unit:mm

Thickness of mounting board	Y <sub>1</sub>	Z
0.75 to 1.25	28.2	12.9
1.25 to 2.00	28.4	

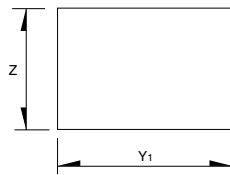

U-shaped Hole Unit:mm

Thickness of mounting board	Y <sub>2</sub>	Z
0.75 to 1.1	28.4	12.9
1.1 to 1.7	28.6	
1.7 to 2	28.8	

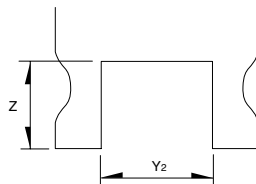

**Note**





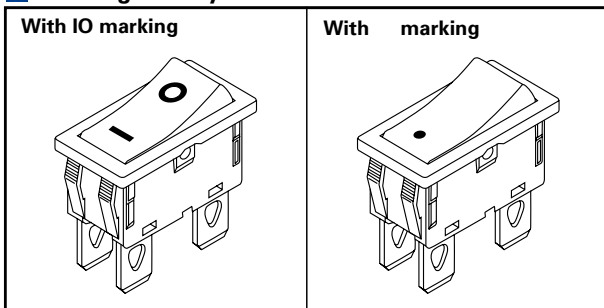

Verify the performance under actual product conditions before use.

**■ Marking Variety**



- Detector
- Push
- Slide
- Rotary
- Encoders
- Power**
- Dual-in-line Package Type
- TACT Switch™
- Custom-Products
- Push Type
- Rocker Type**
- Slide Type
- Rotary Type

## List of Varieties

Items	Type	Push				Rocker	
	Series	SDKN	SDKS	SDKQ	SDKR	SDDJE 1 2	SDDJF 1 2
Photo							
Travel (mm)		9 9.7	14.6	2.5	1.5	3.5	5.2
Remark					Water-proof type		
Operating temperature range		-20 to +60	-30 to +60	-10 to +60	-10 to +85	-10 to +55	
Rating		0.25A 250V AC 0.5A 125V AC 5mA 5V DC	2A 250V AC 4A 125V AC	3A 125V AC	0.5A 250V AC 1A 125V AC	6A/96A 250V ~	16( 6 )/250 ~
Electrical performance	Contact resistance	100m max.	50m max.	100m max.			
	Insulation resistance	500M min. 500V DC	100M min. 500V DC	500M min. 500V DC			
	Voltage proof	1,000V AC for 1minute	1,500V AC for 1minute		1,000V AC for 1minute	2,000V AC for 1minute	
Mechanical performance	Terminal strength	50N for 1minute	70N for 1minute		5N for 1minute	10N for 1minute	60N for 1minute
	Actuator strength	Operating direction	20N		100N	25N	
		Perpendicular direction	20N	30N	20N	25N	
	Resistance to soldering heat	Manual soldering				300 ± 10 , 3 ± 0.5s	350 ± 10 , 3 ± 0.5s
Dip soldering					260 ± 5 , 10 ± 1s	260 ± 10 , 10 ± 1s	
Durability	Operating life	6,000cycles		12,000cycles	100,000cycles	10,000cycles	
		Load : as ratings				Refer to individual product spec.	Load : as ratings
Environmental performance	Cold	-30 ± 2 for 96h	-40 ± 2 for 96h	-25 ± 2 for 240h	-20 ± 2 for 240h	-20 ± 2 for 96h	
	Dry heat	85 ± 2 for 96h		85 ± 2 for 240h		85 ± 2 for 96h	
	Damp heat	40 ± 2 , 90 to 95%RH for 96h		40 ± 2 , 90 to 95%RH for 240h	60 ± 2 , 90 to 95%RH for 1000h	40 ± 2 , 90 to 95%RH for 96h	
Page		215	217	219	220	221	225

Detector

Push

Slide

Rotary

Encoders

Power

Dual-in-line  
Package Type

TACT Switch™

Custom-  
Products

Push  
Type

Rocker  
Type

Slide  
Type

Rotary  
Type

Power Switches Cautions .....235  
 Power Switches Safety Standard .....237, 238, 239

### Notes

1. Dip soldering can be used on SDDJE For PC board terminal and SDDJF right angle terminal types only.
2. The operating temperature range for automotive applications can be raised upon request. Please contact us for requirements of this kind.