

## GaAs PHEMT MMIC LOW NOISE AMPLIFIER, DC - 20 GHz

### Typical Applications

The HMC460 is ideal for:

- Telecom Infrastructure
- Microwave Radio & VSAT
- Military & Space
- Test Instrumentation

### Functional Diagram

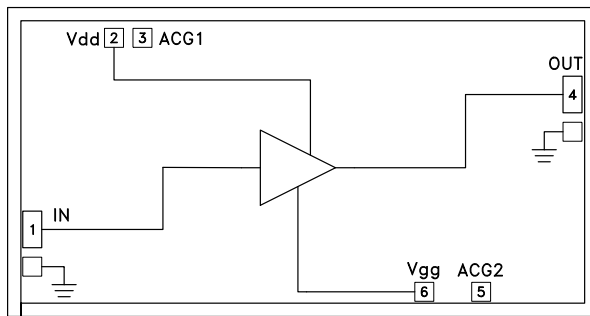

### Features

Noise Figure: 2.5 dB @ 10 GHz

Gain: 14 dB @ 10 GHz

P1dB Output Power: +16 dBm @ 10 GHz

Supply Voltage: +8V @ 60 mA

50 Ohm Matched Input/Output

Die Size: 3.12 x 1.63 x 0.1 mm

### General Description

The HMC460 is a GaAs MMIC PHEMT Low Noise Distributed Amplifier die which operates between DC and 20 GHz. The amplifier provides 14 dB of gain, 2.5 dB noise figure and +16 dBm of output power at 1 dB gain compression while requiring only 60 mA from a +8V supply. The HMC460 amplifier can easily be integrated into Multi-Chip-Modules (MCMs) due to its small size. All data is with the chip in a 50 Ohm test fixture connected via 0.025mm (1 mil) diameter wire bonds of minimal length 0.31mm (12 mils).

### Electrical Specifications, $T_A = +25^\circ \text{C}$ , $V_{dd} = 8\text{V}$ , $I_{dd} = 60 \text{mA}^*$

Parameter	Min.	Typ.	Max.	Min.	Typ.	Max.	Min.	Typ.	Max.	Units
Frequency Range	DC - 6.0			6.0 - 18.0			18.0 - 20.0			GHz
Gain	12	14		12	14		11	13		dB
Gain Flatness		$\pm 0.5$			$\pm 0.15$			$\pm 0.25$		dB
Gain Variation Over Temperature		0.008	0.016		0.01	0.02		0.01	0.02	dB/°C
Noise Figure		4.0	5.0		2.5	3.5		3.0	4.0	dB
Input Return Loss		17			22			15		dB
Output Return Loss		17			15			15		dB
Output Power for 1 dB Compression (P1dB)	14	17		13	16		12	15		dBm
Saturated Output Power (Psat)		18			18			17		dBm
Output Third Order Intercept (IP3)		27.5			28			27		dBm
Supply Current (I <sub>dd</sub> ) (V <sub>dd</sub> = 8V, V <sub>gg1</sub> = -0.9V Typ.)		60			60			60		mA

\* Adjust V<sub>gg</sub> between -2 to 0V to achieve I<sub>dd</sub>= 60 mA typical.

For price, delivery, and to place orders, please contact Hittite Microwave Corporation:  
20 Alpha Road, Chelmsford, MA 01824 Phone: 978-250-3343 Fax: 978-250-3373  
Order On-line at [www.hittite.com](http://www.hittite.com)

**GaAs PHEMT MMIC LOW NOISE  
AMPLIFIER, DC - 20 GHz**

**Broadband Gain & Return Loss**

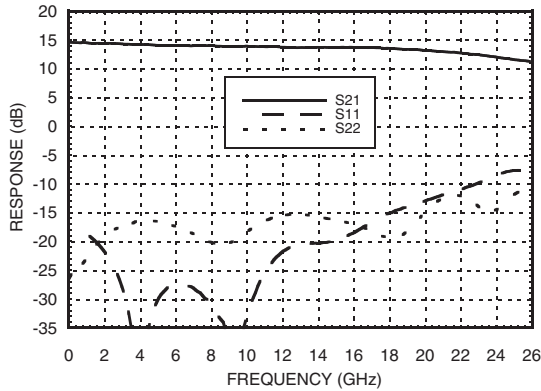

**Gain vs. Temperature**

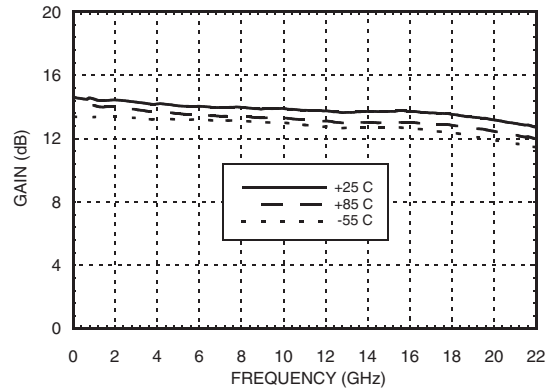

**Input Return Loss vs. Temperature**

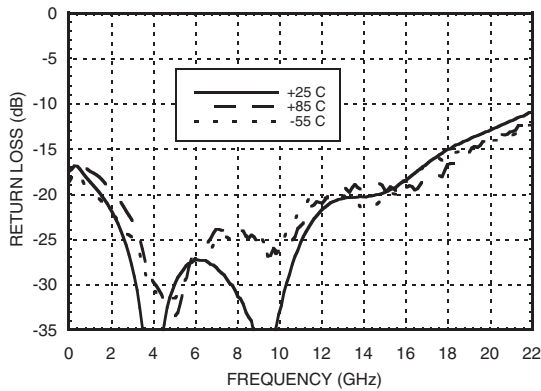

**Output Return Loss vs. Temperature**

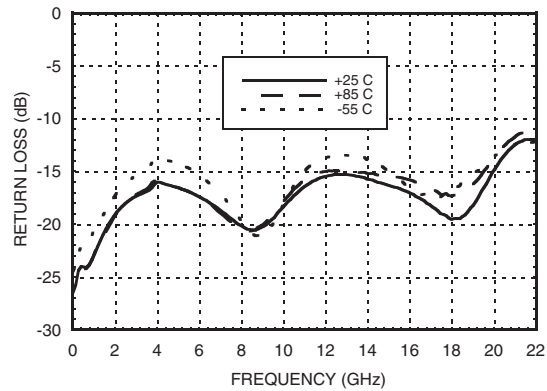

**Low Frequency Gain & Return Loss**

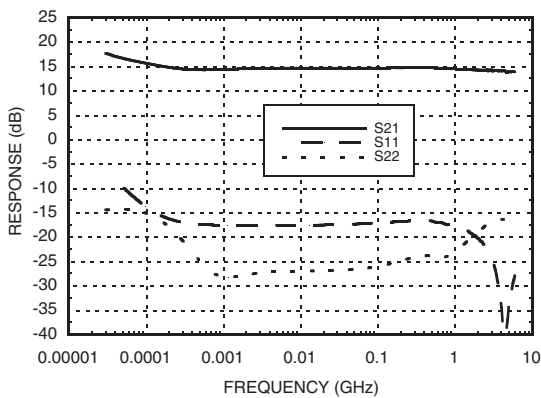

**Noise Figure vs. Temperature**

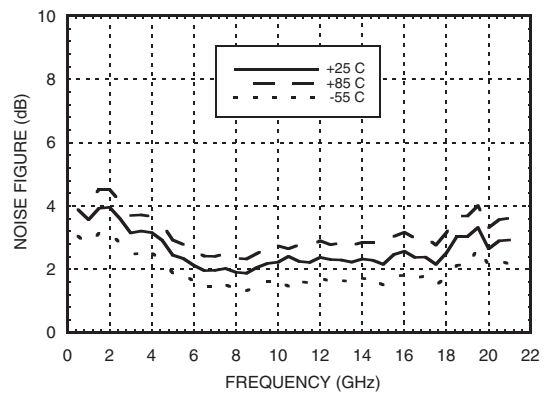

For price, delivery, and to place orders, please contact Hittite Microwave Corporation:  
20 Alpha Road, Chelmsford, MA 01824 Phone: 978-250-3343 Fax: 978-250-3373  
Order On-line at [www.hittite.com](http://www.hittite.com)

**GaAs PHEMT MMIC LOW NOISE  
AMPLIFIER, DC - 20 GHz**

1

LOW NOISE AMPLIFIERS - CHIP

**Output P1dB vs. Temperature**

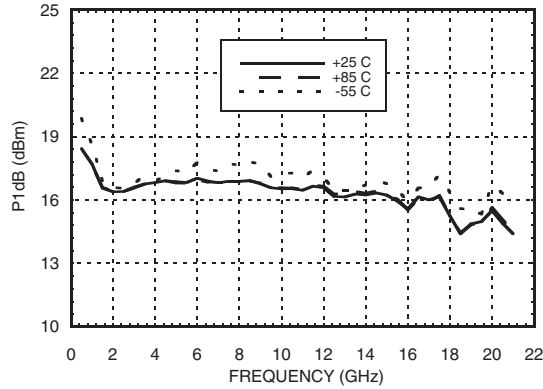

**Psat vs. Temperature**

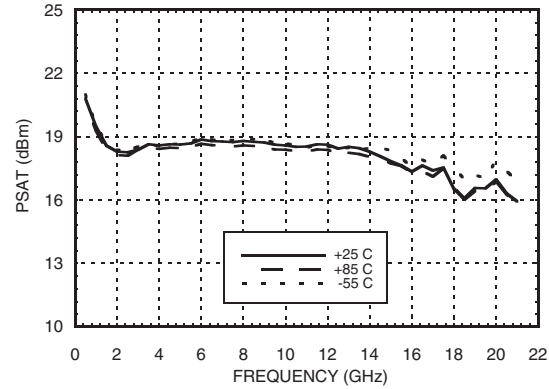

**Output IP3 vs. Temperature**

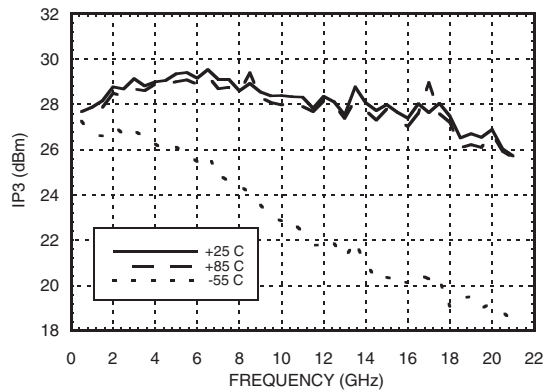

**Gain, Power & Noise Figure  
vs. Supply Voltage @ 10 GHz, Fixed Vgg1**

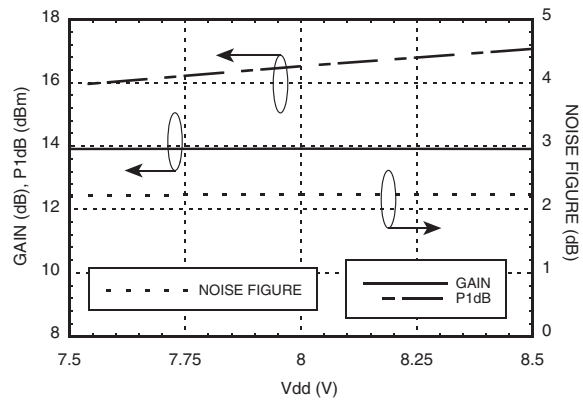

**Reverse Isolation vs. Temperature**

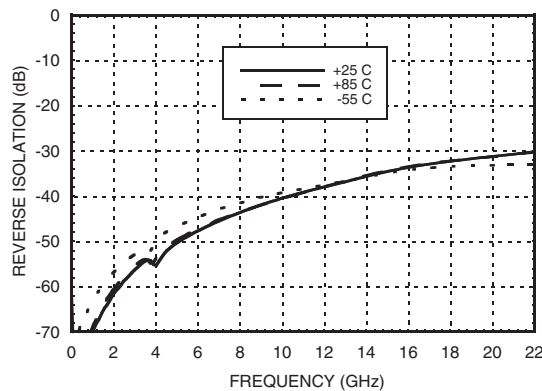

**GaAs PHEMT MMIC LOW NOISE  
AMPLIFIER, DC - 20 GHz**

**Absolute Maximum Ratings**

Drain Bias Voltage (Vdd)	+9 Vdc
Gate Bias Voltage (Vgg1)	-2 to 0 Vdc
RF Input Power (RFIN)(Vdd = +8 Vdc)	+10 dBm
Channel Temperature	175 °C
Continuous Pdiss (T = 85 °C) (derate 24 mW/°C above 85 °C)	2.17 W
Thermal Resistance (channel to die bottom)	41.5 °C/W
Storage Temperature	-65 to +150 °C
Operating Temperature	-55 to +85 °C

**Typical Supply Current vs. Vdd**

Vdd (V)	Idd (mA)
+7.5	59
+8.0	60
+8.5	62



ELECTROSTATIC SENSITIVE DEVICE  
OBSERVE HANDLING PRECAUTIONS

**Outline Drawing**

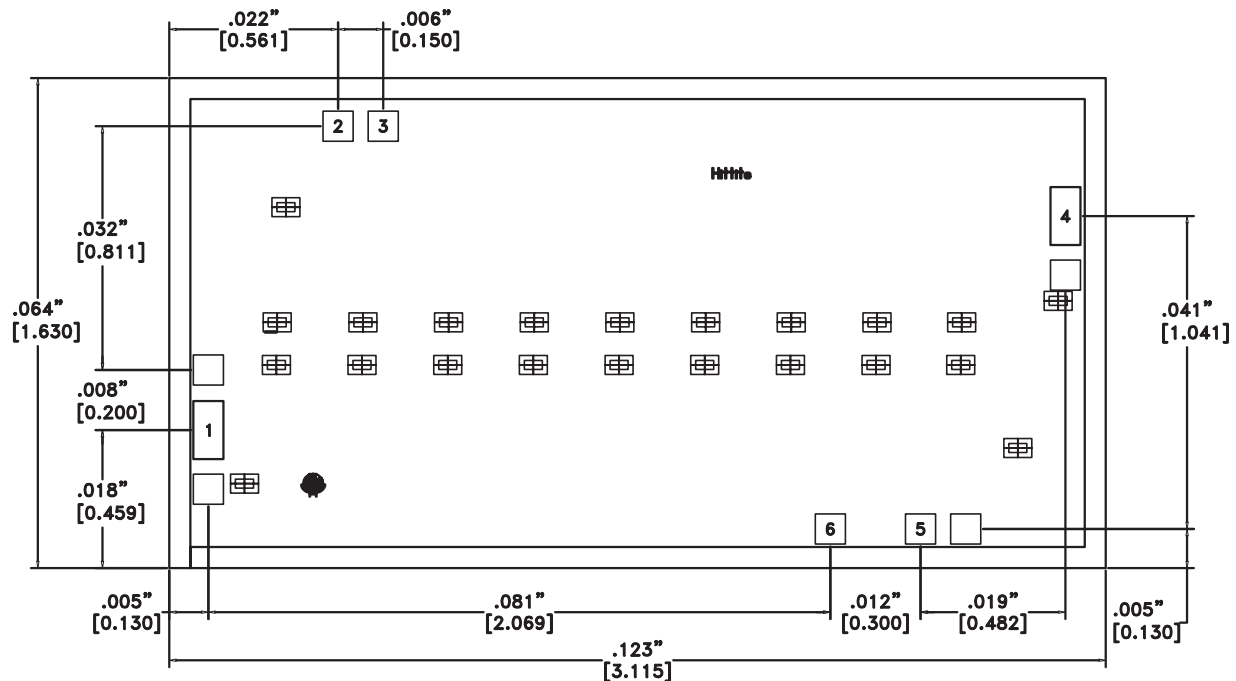

**Die Packaging Information [1]**

Standard	Alternate
GP-1	[2]

[1] Refer to the "Packaging Information" section for die packaging dimensions.

[2] For alternate packaging information contact Hittite Microwave Corporation.





NOTES:

1. ALL DIMENSIONS IN INCHES [MILLIMETERS]
2. NO CONNECTION REQUIRED FOR UNLABELED BOND PADS
3. DIE THICKNESS IS 0.004 (0.100)
4. TYPICAL BOND PAD IS 0.004 (0.100) SQUARE
5. BACKSIDE METALLIZATION: GOLD
6. BACKSIDE METAL IS GROUND
7. BOND PAD METALIZATION: GOLD

For price, delivery, and to place orders, please contact Hittite Microwave Corporation:  
20 Alpha Road, Chelmsford, MA 01824 Phone: 978-250-3343 Fax: 978-250-3373  
Order On-line at [www.hittite.com](http://www.hittite.com)

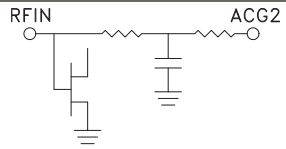
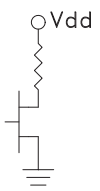
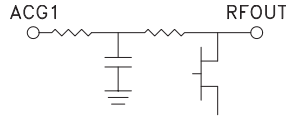
## GaAs PHEMT MMIC LOW NOISE AMPLIFIER, DC - 20 GHz

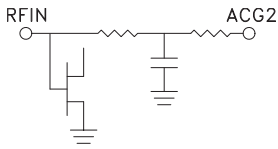
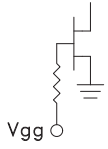
### Pad Descriptions

Pad Number	Function	Description	Interface Schematic
1	RFIN	This pad is DC coupled and matched to 50 Ohms.	
2	Vdd	Power supply voltage for the amplifier. External bypass capacitors are required	
3	ACG1	Low frequency termination. Attach bypass capacitor per application circuit herein.	
4	RFOUT	This pad is DC coupled and matched to 50 Ohms.	
5	ACG2	Low frequency termination. Attach bypass capacitor per application circuit herein.	
6	Vgg	Gate control for amplifier. Adjust to achieve I <sub>dd</sub> = 60 mA.	
Die Bottom	GND	Die bottom must be connected to RF/DC ground.	

**GaAs PHEMT MMIC LOW NOISE  
AMPLIFIER, DC - 20 GHz**

**Assembly Diagram**

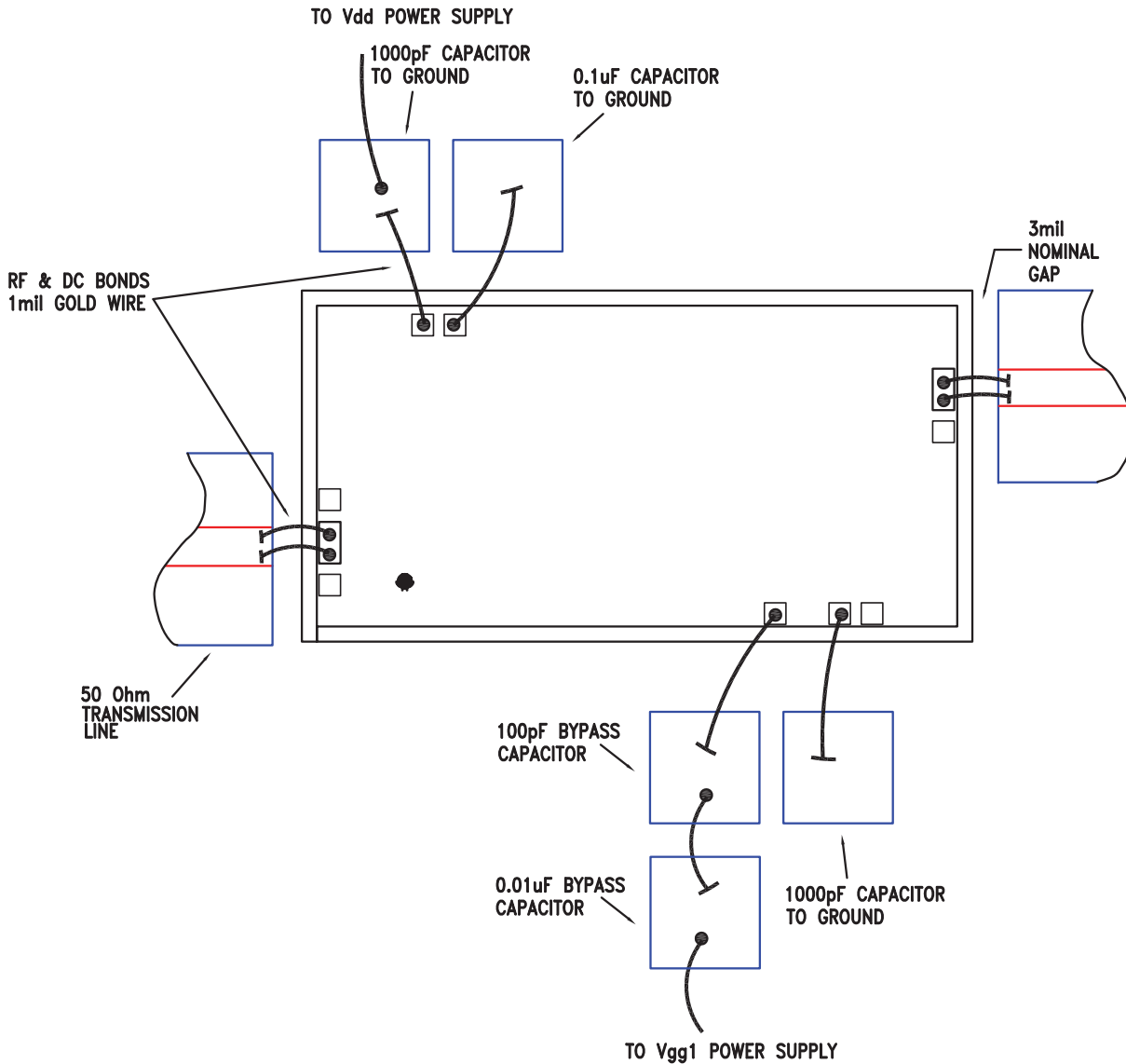

**GaAs PHEMT MMIC LOW NOISE AMPLIFIER, DC - 20 GHz**

**Mounting & Bonding Techniques for Millimeterwave GaAs MMICs**

The die should be attached directly to the ground plane eutectically or with conductive epoxy (see HMC general Handling, Mounting, Bonding Note).

50 Ohm Microstrip transmission lines on 0.127mm (5 mil) thick alumina thin film substrates are recommended for bringing RF to and from the chip (Figure 1). If 0.254mm (10 mil) thick alumina thin film substrates must be used, the die should be raised 0.150mm (6 mils) so that the surface of the die is coplanar with the surface of the substrate. One way to accomplish this is to attach the 0.102mm (4 mil) thick die to a 0.150mm (6 mil) thick molybdenum heat spreader (moly-tab) which is then attached to the ground plane (Figure 2).

Microstrip substrates should be brought as close to the die as possible in order to minimize bond wire length. Typical die-to-substrate spacing is 0.076mm to 0.152 mm (3 to 6 mils).

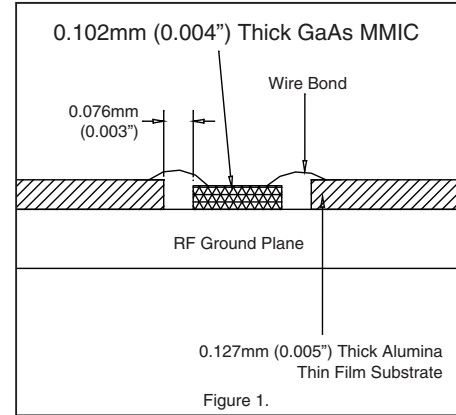

Figure 1.

**Handling Precautions**

Follow these precautions to avoid permanent damage.

**Storage:** All bare die are placed in either Waffle or Gel based ESD protective containers, and then sealed in an ESD protective bag for shipment. Once the sealed ESD protective bag has been opened, all die should be stored in a dry nitrogen environment.

**Cleanliness:** Handle the chips in a clean environment. DO NOT attempt to clean the chip using liquid cleaning systems.

**Static Sensitivity:** Follow ESD precautions to protect against ESD strikes.

**Transients:** Suppress instrument and bias supply transients while bias is applied. Use shielded signal and bias cables to minimize inductive pick-up.

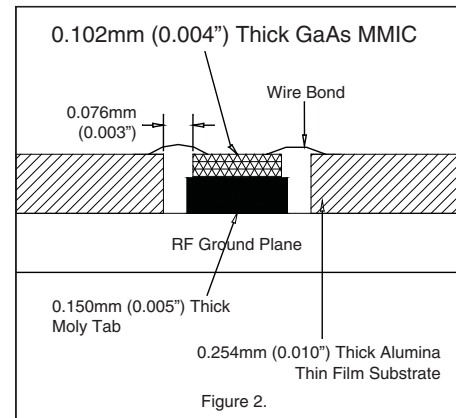

Figure 2.

**General Handling:** Handle the chip along the edges with a vacuum collet or with a sharp pair of bent tweezers. The surface of the chip has fragile air bridges and should not be touched with vacuum collet, tweezers, or fingers.

**Mounting**

The chip is back-metallized and can be die mounted with AuSn eutectic preforms or with electrically conductive epoxy. The mounting surface should be clean and flat.

**Eutectic Die Attach:** A 80/20 gold tin preform is recommended with a work surface temperature of 255 °C and a tool temperature of 265 °C. When hot 90/10 nitrogen/hydrogen gas is applied, tool tip temperature should be 290 °C. DO NOT expose the chip to a temperature greater than 320 °C for more than 20 seconds. No more than 3 seconds of scrubbing should be required for attachment.

**Epoxy Die Attach:** Apply a minimum amount of epoxy to the mounting surface so that a thin epoxy fillet is observed around the perimeter of the chip once it is placed into position. Cure epoxy per the manufacturer's schedule.

**Wire Bonding**

Ball or wedge bond with 0.025mm (1 mil) diameter pure gold wire. Thermosonic wirebonding with a nominal stage temperature of 150 °C and a ball bonding force of 40 to 50 grams or wedge bonding force of 18 to 22 grams is recommended. Use the minimum level of ultrasonic energy to achieve reliable wirebonds. Wirebonds should be started on the chip and terminated on the package or substrate. All bonds should be as short as possible <0.31mm (12 mils).

**GaAs PHEMT MMIC LOW NOISE  
AMPLIFIER, DC - 20 GHz**

**Notes:**