

NEW

Radiometrix

Hartcran House, 231 Kenton Lane, Harrow, HA3 8RP, England

Issue 1, 01 December 2008

Tel: +44 (0) 20 8909 9595, Fax: +44 (0) 20 8909 2233

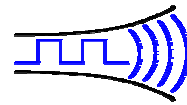

TX2A/RX2G

UHF FM Data Transmitter and Receiver Modules

The TX2A and RX2G data radio modules are PLL synthesiser based miniature PCB mounting UHF radio transmitter and receiver pair which enable the simple implementation of a wireless data link at up to 64 kbps at distances up to 75 metres in-building and 300 metres open ground.

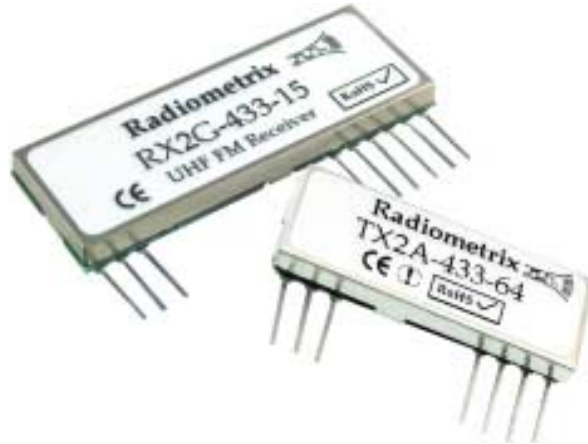

Figure 1: RX2G-433-15 & TX2A-433-64

Features

- Designed for compliance with EN 300 220-3 (radio) and EN 301 489-3 (EMC) standards
- Data rates up to 64 kbps
- Usable range up to 300 m
- Versions available on 433.92MHz, 434.42MHz and 434.525MHz
- Fully screened

Available for operation at 433.92MHz or 434.42MHz in the UK and Europe, both modules combine full screening with extensive internal filtering to ensure EMC compliance by minimising spurious radiations and susceptibilities. The TX2A and RX2G modules will suit one-to-one and multi-node wireless links in applications including car and building security, EPOS and inventory tracking, remote industrial process monitoring and computer networking. Because of their small size and low power requirements, both modules are ideal for use in portable, battery-powered applications such as hand-held terminals.

Technical Summary

Transmitter - TX2A

- Crystal-locked PLL, FM modulated at up to 64 Kbps
- Operation from 2.2V to 16V (Dependent on version)
- +10dBm on 433.92MHz
- High efficiency, >30%, DC to RF
- Improved frequency and deviation accuracy
- 2nd harmonic, > -60dBc

Receiver - RX2G

- Single conversion FM superhet
- SAW front end filter gives >50dB image rejection
- Supply: +5V ($\pm 10\%$)
- Current consumption: 10mA (typ.)
- -102dBm sensitivity @ 1ppm BER, 64kbps version
- -108dBm sensitivity @ 1ppm BER, 15kbps version
- RSSI output with 50dB range
- Extremely low LO leakage, -125dBm typical

Evaluation platforms: Universal Evaluation Kit, NBEK + SIL carrier

Functional description

The TX2A transmitter module is a crystal based PLL controlled FM transmitter operating between 2.2V and 16V and is available in 433.92MHz. The TX2A module is type approved to EN 300 220-3 for European use and delivers nominally +10dBm at 11mA. The module measures 32 x 12 x 3.8 mm.

The RX2G module is a single conversion FM superhet receiver capable of handling data rates of up to 64kbps. RX2G needs a regulated 5V supply and draws 10mA when receiving. The RX2G features a fast power-up time for effective duty cycle power saving and a signal strength (RSSI) output with 50dB of range. Full screening and a SAW front-end filter give good immunity to interference. The SIL style RX2G measures 48 x 17.5 x 4.5 mm excluding the pins.

TX2A transmitter

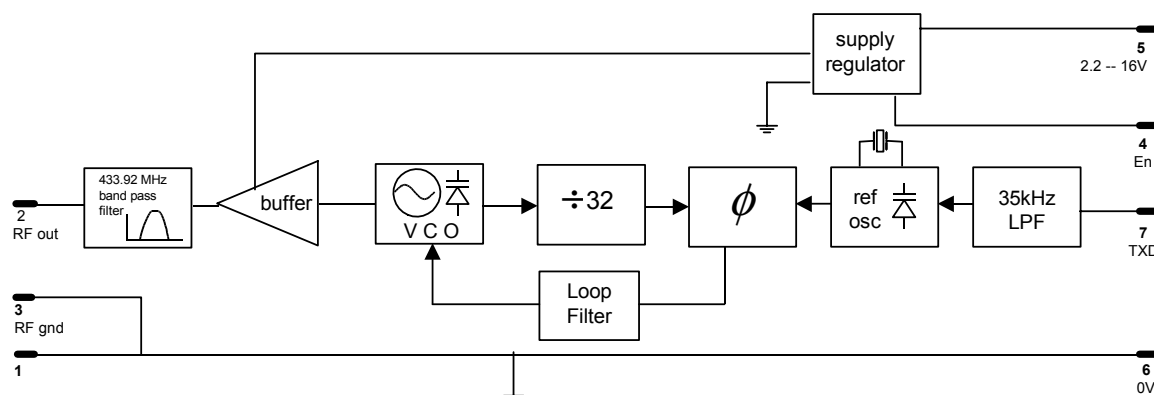

Fig. 2: TX2A block diagram

Pin description:

RF GND (pins 1&3)

RF ground, internally connected to the module screen and pin 6 (0V). These pins should be directly connected to the RF return path - e.g. coax braid, main PCB ground plane etc.

RF OUT (pin 2)

50Ω RF output to the antenna. Internally DC-isolated. See antenna section of apps notes for details of suitable antennas.

En (pin 4)

Tx enable. <0.15V shuts down module (current <1μA). >1.7V enables the transmitter. Impedance ~1MΩ. Observe slew rate requirements (see apps notes).

Vcc (pin 5)

+2.2V to +16V DC supply. Max ripple content 0.1V_{P-P}. Decoupling is not generally required.

0V (pin 6)

DC supply ground. Internally connected to pins 1 & 3 and module screen.

TXD (pin 7)

DC-coupled modulation input. Accepts serial digital data at 0V to 2.5V levels. See applications notes for suggested drive methods. Input is high impedance (>100kΩ).

Notes: 1. The 3V and 5V supply variant TX2As intended for direct replacement to our SAW based TX2 modules and do not have internal regulator. They also have identical pin out as of TX2, hence lack pin 3 (GND) and pin 4 (Enable).
2. The TXD input of 3V and 5V versions require serial digital data at 0-Vcc levels. i.e. 0-3V and 0-5V respectively

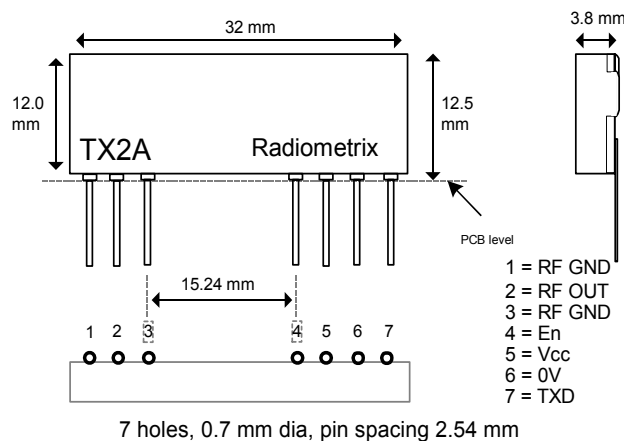

Fig 3: TX2A physical dimensions

RX2G receiver

Pin description

RF IN (pin 1)

50Ω input from the antenna, DC isolated.

RF GND (pin 2/3)

RF ground pin, internally connected to the module screen and pin 6 (0V). This pin should be connected to the RF return path (coax braid, main PCB ground plane etc.)

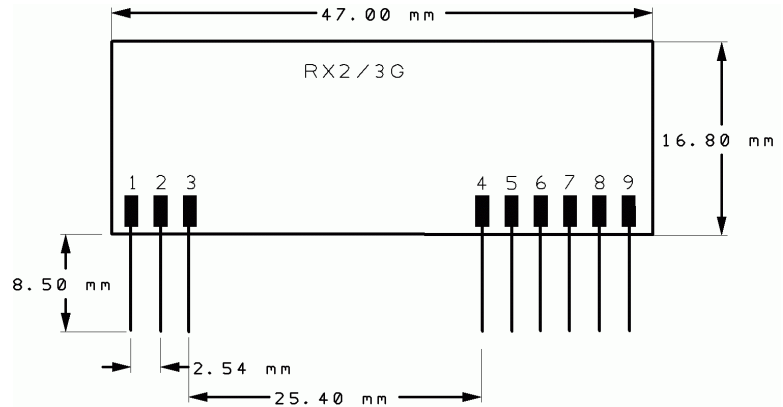

Fig 4: physical dimensions & pin outs

En (Regulator version) (pin 4)

Rx enable. <0.15V shuts down module (current <1uA). >1.7V enables the receiver. Impedance ~1Mohm. Observe slew rate requirements (see apps notes).

RSSI (pin 5)

Received signal strength indicator with 60dB range. See page 4 for typical characteristics.

0V (pin 6)

DC supply ground. Internally connected to pin 2 & 3 and module screen.

Vcc (pin 7)

5V regulated DC supply. Max ripple content 0.1V_{p-p}.

AF out (pin 8)

Buffered and filtered analogue output from the FM demodulator. Standing DC bias 2V approx. External load should be >10kΩ // <100pF.

RXD (pin 9)

This digital output from the internal data slicer is a squared version of the signal on pin 8 (AF). It may be used to drive external decoders. The data is true data, i.e. as fed to the transmitter.

Absolute maximum ratings

Survival Maximums:

Exceeding the values given below may cause permanent damage to the module.

Operating temperature-	-20°C to +70°C
Storage temperature	-40°C to +100°C

TX2A, all variants

Vcc (pin 3)	-0.3V to +16.0V
Data input (pin 5)	+/- 7V
RF out (pin 2)	±50V DC 10dBm RF

RX2G all variants

Vcc (pin 7)	-0.1V to +5.5V
RSSI, AF, RXD (pins 5,8,9)	-0.1V to +3V
RF IN (pin 1)	±50V DC, +10dBm RF

Performance Specifications: TX2A transmitter.

(Temperature = 20C unless stated)

	pin	min.	typ.	max.	units	notes
DC LEVELS						
supply voltage	3	2.2	3.0	4.0	V	-3V version
supply voltage	3	4.0	5.0	6.0	V	-5V version
supply voltage	3	3	-	16	V	STD
CURRENT & RF POWER						
<i>TX2A-433-64-3V</i>						
supply current @ Vcc = 3V	3	9	11	13	mA	
RF power @ Vcc = 3V	2	+8	+10	+12	dBm	1
<i>TX2A-433-64-5V</i>						
supply current @ Vcc = 5V	3	9	11	13	mA	
RF power @ Vcc = 5V	2	+8	+10	+12	dBm	1
<i>TX2A-433-64-STD</i>						
supply current @ Vcc = 5V	3	9	11	13	mA	
RF power @ Vcc = 5V	2	+8	+10	+12	dBm	1
RF						
2 nd harmonic	2	-	-70	-54	dBc	1
harmonics @ > 1GHz	2	-	-60	-40	dBc	1
initial frequency accuracy	-	-20	+/-10	+20	kHz	
overall frequency accuracy	-	-25	+/-10	+25	kHz	
FM deviation (+/-)	-	20	27	35	kHz	
Modulation bandwidth @ -3dB	-	DC	-	35	kHz	
modulation distortion (THD)	-	-	5	10	%	
power up time to full RF	-	-	1	1.5	ms	

Note: 1. Measured into a 50Ω load.

Performance specifications: RX2G

(Vcc = 5.0V / temperature = 20 °C unless stated)

	pin	min.	typ.	max.	unit	notes
DC supply						
Supply voltage	5	4.5	5.0	5.5	V	
Supply voltage (regulator ver.)	5	4.5	5.0	16	V	
Supply current	5	9	15	18	mA	1
RF/IF						
RF sensitivity for 10dB (S+N/N)	1,2	-	-113	-	dBm	
RF sensitivity for 1ppm BER	1,2	-	-108	-	dBm	15kbps version
RF sensitivity for 1ppm BER	1,2	-	-102	-	dBm	64kbps version
RSSI range	1,2	-	50	-	dB	
IF bandwidth	-	-	180	-	kHz	
Image rejection	1	50	54	-	dB	
IF rejection (10.7MHz)	1	100	-	-	dB	
LO leakage, conducted	1	-	-125	-110	dBm	
Baseband						
Baseband bandwidth @ -3dB	8	0	-	7.8	kHz	15kbps version
Baseband bandwidth @ -3dB	8	0	-	50	kHz	64kbps version
AF level	8	200	250	350	mV _P	2
DC offset on AF out	8	1.5	2	2.5	V	3
Distortion on recovered AF	8	-	1	5	%	3
Load capacitance, AFout/RXD	3,8	-	-	100	pF	
DYNAMIC TIMING						
Power up with signal present						
Power up to valid RSSI	3,5	-	0.5	1	ms	
Power up to stable data	3,9	-	2	10	ms	3, 15kbps version
Power up to stable data	3,9	-	2	10	ms	3, 64kbps version
Signal applied with supply on						
RSSI response time (rise/fall)	1,5	-	100	-	µs	
Signal to stable data	1,9	-	0.5	1	ms	3, 15kbps version
Signal to stable data	1,9	-	0.2	0.5	ms	3, 64kbps version
Time between data transitions	9	70	-	5000	µs	4, 15kbps version
Time between data transitions	9	15.6	-	1500	µs	4, 64kbps version
Mark:space ratio	9	20	50	80	%	5

- Notes:**
1. Current increases at higher RF input levels (>-20dBm and above).
 2. For received signal with ±30kHz FM deviation.
 3. Typical figures are for signal at centre frequency, max. figures are for ±50kHz offset.
 4. For 50:50 mark to space ratio (i.e. squarewave).
 5. Average over 10ms (15kbps version) or 3ms (64kbps version) at maximum data rate

Power supply requirement

The standard TX2A module incorporates a built-in regulator which delivers a constant 2.8V to the module circuitry when the external supply voltage is 2.85V or greater, with 40dB or more of supply ripple rejection. This ensures constant performance up to the maximum permitted supply rail and removes the need for external supply decoupling except in cases where the supply rail is extremely poor (ripple/noise content >0.1Vp-p).

Note, however, that for supply voltages lower than 2.85V the regulator is effectively inoperative and supply ripple rejection is considerably reduced. Under these conditions the ripple/noise on the supply rail should be below 10mVp-p to avoid problems. If the quality of the supply is in doubt, it is recommended that a 10 μ F low-ESR tantalum or similar capacitor be added between the module supply pin (Vcc) and ground, together with a 10 Ω series feed resistor between the Vcc pin and the supply rail.

The Enable pin allows the module to be turned on or off under logic control with a constant DC supply to the Vcc pin. The module current in power-down mode is less than 1 μ A.

NOTE: If this facility is used, the logic control signal must have a slew rate of 40mV/ms or more. Slew rates less than this value may cause erratic operation of the on-board regulator and therefore the module itself.

The TX2A incorporates a low voltage shutoff circuit, which prevents any possibility of erratic operation by disabling the RF output if the supply voltage drops below 2.2V (\pm 5%). This feature is self-resetting, i.e. restoring the supply to greater than 2.2V will immediately restore full RF output from the module.

The standard RX2G requires a regulated 5V supply with ripple content <100mVpk-pk.

However, a built-in regulator version is also available. The regulator version can be operated from 5V (minimum) up to 16V (maximum permitted) supply rail and removes the need for external supply decoupling except in cases where the supply rail is extremely poor (ripple/noise content >0.1Vp-p).

TX2A modulation requirements

The module will produce the specified FM deviation with a TXD input to pin 7 of 2.5V amplitude, i.e. 0V "low", 2.5V "high". Reducing the amplitude of the data input from this value (usually as a result of reducing the supply voltage) reduces the transmitted FM deviation to typically \pm 25kHz at the lower extreme of 2.2V. The receiver will cope with this quite happily and no significant degradation of link performance should be observed as a result.

Where standard 2-level digital data is employed with a logic "low" level of 0V \pm 0.2V, the logic "high" level applied to TXD may be any value between +2.5V and +3V for correct operation. However, if using multi-level or analogue signalling the maximum positive excursion of the modulation applied to TXD must not exceed +2.5V or waveform distortion will result. If the input waveform exceeds this level a resistive potential divider should be used at the TXD input to reduce the waveform amplitude accordingly. This input is high impedance (>100k Ω) and can usually be ignored when calculating required resistor values.

Received Signal Strength Indicator (RSSI)

The RX2G module incorporates a wide range RSSI which measures the strength of an incoming signal over a range of approximately 60dB. This allows assessment of link quality and available margin and is useful when performing range tests.

Please note that the actual RSSI voltage at any given RF input level varies somewhat between units. The RSSI facility is intended as a relative indicator only - it is not designed to be, or suitable as, an accurate and repeatable measure of absolute signal level or transmitter-receiver distance.

The output on pin 5 of the module has a standing DC bias in the region of 0.5V with no signal, rising to around 1V at maximum indication. The RSSI output source impedance is high (\sim 100k Ω) and external loading should therefore be kept to a minimum.

To ensure a fast response the RSSI has limited internal decoupling of 1nF to ground. This may result in a small amount of ripple on the DC output at pin 5 of the module. If this is a problem further decoupling may be added at the expense of response speed, in the form of a capacitor from pin 5 to ground. For example, adding 10nF here will increase RSSI response time from 100 μ s to around 1ms. The value of this capacitor may be increased without limit.

Typical RSSI characteristic is shown below (this is for indicative purposes only and is not a guarantee of actual RSSI characteristics):

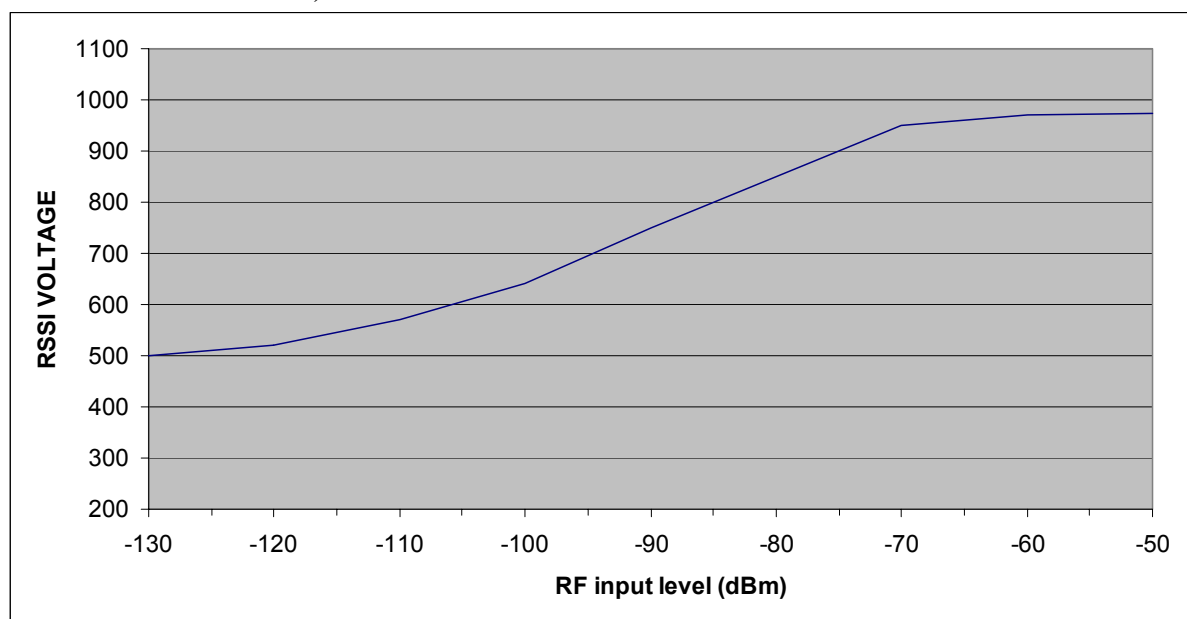

Figure 5: Typical RSSI response

Module mounting considerations

The module may be mounted vertically or bent horizontal to the motherboard. Good RF layout practice should be observed – in particular, any ground return required by the antenna or feed should be connected directly to the RF GND pin at the antenna end of the module, and not to the OV pin which is intended as a DC ground only. All connecting tracks should be kept as short as possible to avoid any problems with stray RF pickup.

If the connection between module and antenna does not form part of the antenna itself, it should be made using 50Ω microstrip line or coax or a combination of both. It is desirable (but not essential) to fill all unused PCB area around the module with ground plane.

The module may be potted if required in a viscous compound which cannot enter the screen can.

Warning: DO NOT wash the module. It is not hermetically sealed.

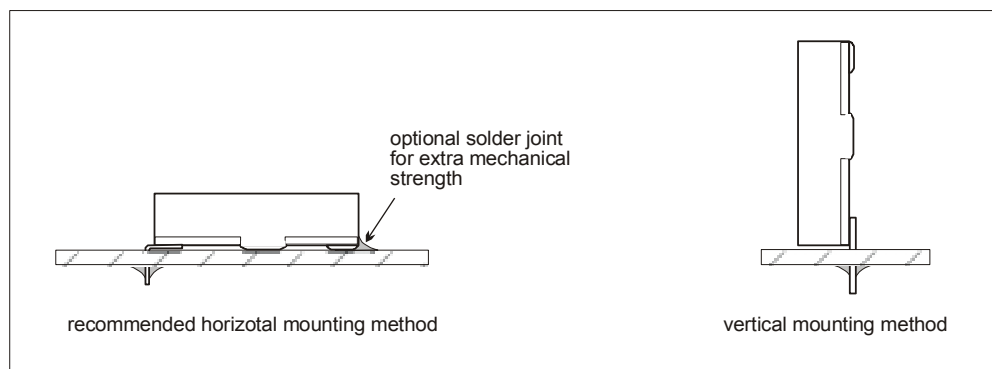

Figure 6: Module mounting options

Antenna requirements

Three types of integral antenna are recommended and approved for use with the module:

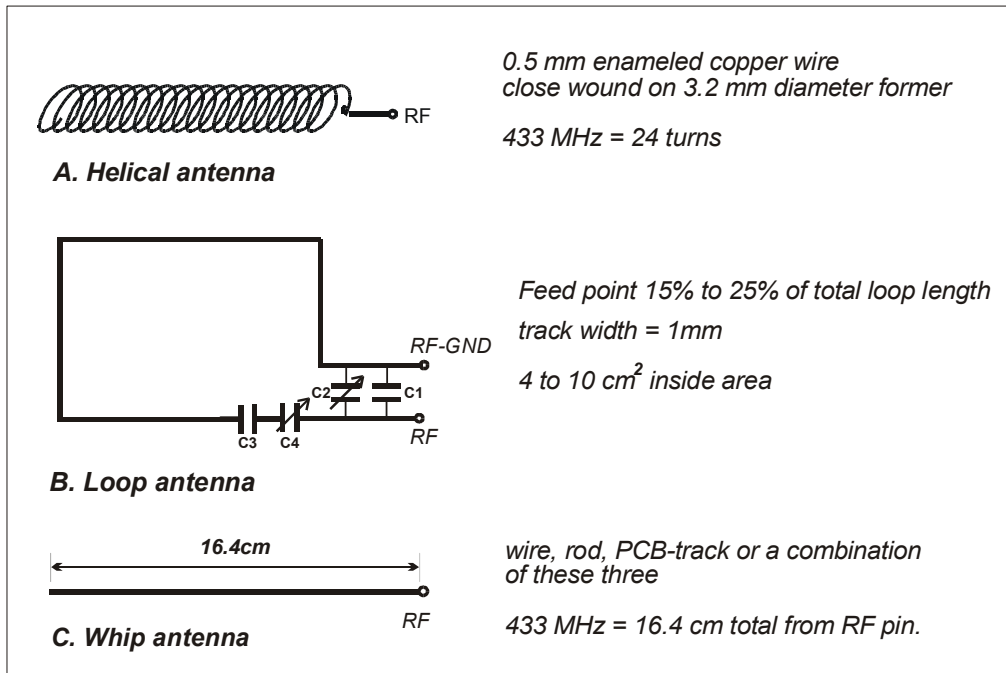

Fig. 7: Antenna

	A	B	C
	<i>helical</i>	<i>loop</i>	<i>whip</i>
Ultimate performance	**	*	***
Easy of design set-up	**	*	***
Size	***	**	*
Immunity proximity effects	**	***	*
Range open ground to similar antenna (for TX2A-433-14-5V & RX2G-433-15-5V)	200m	100m	300m

Antenna selection chart

- A) *Helical* Wire coil, connected directly to pin 2, open circuit at other end. This antenna is very efficient given it's small size (20mm x 4mm dia.). The helical is a high Q antenna, trim the wire length or expand the coil for optimum results. The helical de-tunes badly with proximity to other conductive objects.
- B) *Loop* A loop of PCB track tuned by a fixed or variable capacitor to ground at the 'hot' end and fed from pin 2 at a point 20% from the ground end. Loops have high immunity to proximity de-tuning.
- C) *Whip* This is a wire, rod, PCB track or combination connected directly to pin 2 of the module. Optimum total length is 15.5cm (1/4 wave @ 433MHz). Keep the open circuit (hot) end well away from metal components to prevent serious de-tuning. Whips are ground plane sensitive and will benefit from internal 1/4 wave earthed radial(s) if the product is small and plastic cased

The antenna choice and position directly controls the system range. Keep it clear of other metal in the system, particularly the 'hot' end. The best position by far, is sticking out the top of the product. This is often not desirable for practical/ergonomic reasons thus a compromise may need to be reached. If an internal antenna must be used try to keep it away from other metal components, particularly large ones like transformers, batteries and PCB tracks/earth plane. The space around the antenna is as important as the antenna itself

Duty Cycle requirements

The duty cycle is defined as the ratio, expressed as a percentage, of the maximum transmitter “on” time on one or more carrier frequencies, relative to a one hour period. Where an acknowledgement message is required, the additional transmitter “on” time shall be included.

There is a 10% duty cycle restriction on 433.050-434.790 MHz band in most of the EU member states.

The TX2A-433 is a RF module intended to be incorporated into a wide variety of applications and finished products, Radiometrix has no control over the end use of the TX2A-433. The harmonised band 433.050 to 434.790 MHz as detailed in Annex 1 Band E of CEPT/ERC Recommendation 70-03 (which can be downloaded at <http://www.ero.dk/scripts/docmanag98/dm.dll/QueryDoc?Cat=Recommendation>) has list of countries where Duty Cycle restriction apply.

Module users should, therefore, ensure that they comply with the stated Duty Cycle requirements of the version of CEPT/ERC Recommendation 70-03 in place at the time of incorporation of the TX2A-433 into their product. It should be noted that the stated Duty Cycle must not be exceeded otherwise any approval granted for the TX2A-433 will be invalidated.

Variants and ordering information

The TX2A is manufactured in several variants depending on their supply voltage and operating frequency:

Supply voltage: 3V version: TX2A-433-64-3V	Direct replacement for the TX2-433-40-3V
5V version: TX2A-433-64-5V	Direct replacement for the TX2-433-40-5V
Standard: TX2A-433-64	Different frequency replacement for TX3A

The RX2G receivers are also manufactured in several variants:

Data rate: Slower version:	7.8kHz baseband B/W, (suffix -15)	data rate up to 15kb/s
Faster version:	50kHz baseband B/W, (suffix -64)	data rate up to 64kb/s

The following variants are standard:

RX2G-433-15-5V	433.92MHz, 15kb/s
RX2G-433-64-5V	433.92MHz, 64kb/s

Regulator version:

RX2G-433-15	433.92MHz, 15kb/s
RX2G-433-64	433.92MHz, 64kb/s

TX2A/RX2G pair is available on the following frequencies as standard

Frequency: 433.92MHz	(suffix -433)
434.42MHz	(suffix -434.42)
434.525MHz	(suffix -434.525)

For other frequency variants, please contact sales department.

Evaluation platforms:

1. Universal Evaluation Kit
2. NBEK + SIL carrier

Radiometrix Ltd

**Hartercran House
231 Kenton Lane
Harrow, Middlesex
HA3 8RP**

ENGLAND

Tel: +44 (0) 20 8909 9595

Fax: +44 (0) 20 8909 2233

sales@radiometrix.com

www.radiometrix.com

Copyright notice

This product data sheet is the original work and copyrighted property of Radiometrix Ltd. Reproduction in whole or in part must give clear acknowledgement to the copyright owner.

Limitation of liability

The information furnished by Radiometrix Ltd is believed to be accurate and reliable. Radiometrix Ltd reserves the right to make changes or improvements in the design, specification or manufacture of its subassembly products without notice. Radiometrix Ltd does not assume any liability arising from the application or use of any product or circuit described herein, nor for any infringements of patents or other rights of third parties which may result from the use of its products. This data sheet neither states nor implies warranty of any kind, including fitness for any particular application. These radio devices may be subject to radio interference and may not function as intended if interference is present. We do NOT recommend their use for life critical applications.

The Intrastat commodity code for all our modules is: 8542 6000

R&TTE Directive

After 7 April 2001 the manufacturer can only place finished product on the market under the provisions of the R&TTE Directive. Equipment within the scope of the R&TTE Directive may demonstrate compliance to the essential requirements specified in Article 3 of the Directive, as appropriate to the particular equipment.

Further details are available on The Office of Communications (Ofcom) web site:

<http://www.ofcom.org.uk/radiocomms/ifi/>

Information Requests

Ofcom

Riverside House

2a Southwark Bridge Road

London SE1 9HA

Tel: +44 (0)845 456 3000 or 020 7981 3040

Fax: +44 (0)20 7783 4033

information.requests@ofcom.org.uk

European Radiocommunications Office (ERO)

Peblingehus

Nansensgade 19

DK 1366 Copenhagen

Tel. +45 33896300

Fax +45 33896330

ero@ero.dk

www.ero.dk