

FEATURES

- Precision, autozeroing, factory-calibrated A/D converter
- Scientific-grade accuracy, ± 2 counts
- Miniature size: 2.17" x 0.92" x 0.56"
55mm x 23mm x 14mm
- Large (0.52"/13.2mm) LED display
- Choice of red, green or yellow colors
- High-intensity or low-power red LED's optional
- Single +5V supply (175mW for low-power models)
- Epoxy-encapsulated, 12-pin DIP with built-in color filter and bezel
- 3 differential input voltage ranges
- DISPLAY HOLD and TEST functions
- Optional BCD data outputs for CPU interface
- 0 to +50°C temperature range

DMS-40PC Series, 4½ Digit, LED Display, Miniature DPM's are fully self-contained, component-like, plug-in meters that provide scientific-grade accuracy (typically ± 2 counts or $\pm 0.005\%$ of full scale) and outstanding reliability at a very affordable price.

Within its miniature (2.17" x 0.92" x 0.56"), epoxy-encapsulated package, each meter contains a precision reference circuit; a high-resolution, autozeroing, factory-calibrated A/D converter; and a large (0.52"/13.2mm), easy-to-read, LED display. LED's are available in red, yellow and green colors. Red LED's are also offered in high-intensity or low-power versions.

The versatile design of the DMS-40PC Series assures trouble-free installation and long-term operation. Differential input voltage ranges include $\pm 2V$, $\pm 20V$ and $\pm 200V$. Input impedance is a minimum 800k Ω . Non-inverting inputs are overvoltage protected to $\pm 250V$, and CMRR is typically 86dB (dc to 60Hz).

The DMS-40PC's epoxy-encapsulated package has an integral bezel and color filter. The moisture and vibration-proof package is extremely rugged and well suited for harsh environments and extended temperatures. Devices are fully specified for 0 to +50°C operation.

All models operate from a single +5V supply and typically consume 500mW. Low-power models, whose display is just as bright as standard models, typically consume 175mW. DISPLAY TEST and HOLD functions are standard on each meter, and a complete set of BCD outputs are optional for sending data to CPU's or remote displays.

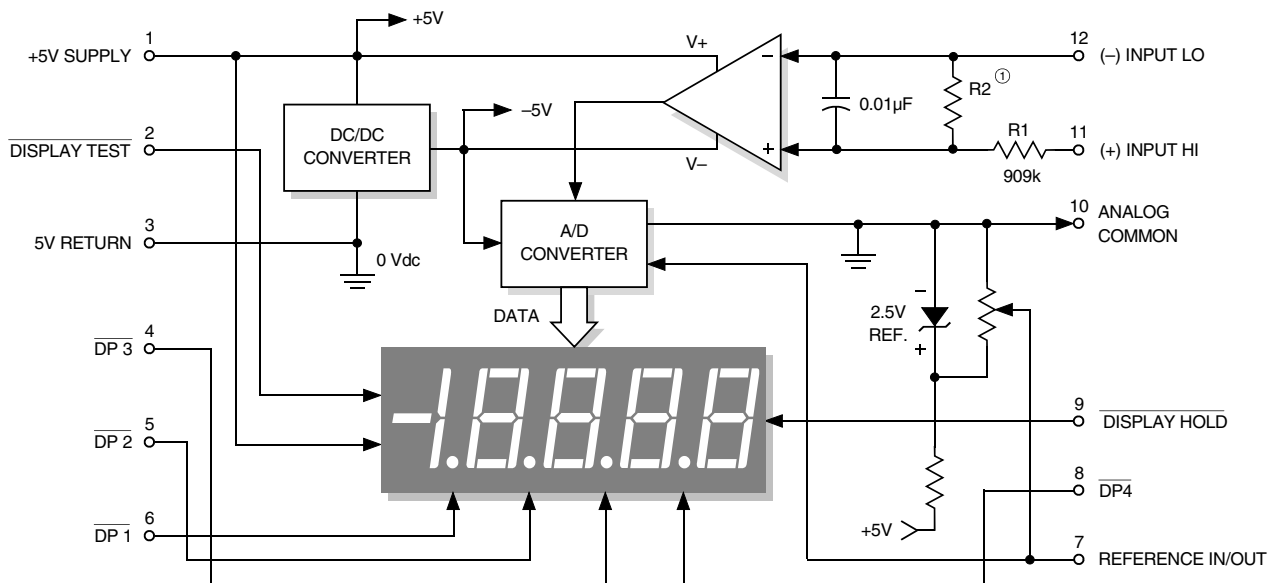

① R2 is not used on $\pm 2V$ (-1) models.
R2 = 101k on $\pm 20V$ (-2) models and 9.2k on $\pm 200V$ (-3) models.



Performance/Functional Specifications

Typical at T_A = +25°C and supply voltage = +5V using the single-ended input circuit, unless otherwise noted.

Analog Inputs	Min.	Typ.	Max.	Units
Full Scale Input Range:				
DMS-40PC-1	–	±2	–	Volts
DMS-40PC-2	–	±20	–	Volts
DMS-40PC-3	–	±200	–	Volts
Input Impedance:				
DMS-40PC-1	100	1000	–	MΩ
DMS-40PC-2, -3	0.8	1	–	MΩ
Overvoltage Protection ①				
	–	–	±250	Volts
Common Mode Voltage Range				
	–	–	±2	Volts
CMRR (dc to 60Hz)				
	–	86	–	dB
Control Inputs ②				
Decimal Pt. Placement (Pins 4-6, 8)	Tie to pin 3 to activate			
Display Test (Pin 2)	Tie to pin 3 to activate all segments			
Display Hold (Pin 9)	Tie to pin 3 to hold last reading			
BCD Outputs ③				
Logic Levels (1 LSTTL load max.):				
Logic "1"	+2.4	–	–	Volts
Logic "2"	–	+0.4	+0.8	Volts
Performance				
Sampling Rate	2.5 reading per second			
Accuracy (3 minute warm-up):				
DMS-40PC-1 (Vin = +1.9V)	–	±2	±3	Counts
DMS-40PC-2 (Vin = +19V)	–	±3	±4	Counts
DMS-40PC-3 (Vin = +190V)	–	±3	±4	Counts
Zero Reading (Vin = 0 Volts)	"–001"	"000"	"001"	
Temperature Drift (0 = +50°C)				
DMS-40PC-1	–	±0.4	±1	Cnts/°C
DMS-40PC-2, -3	–	±0.4	±1.5	Cnts/°C
Power Supply Requirements				
Supply Voltage	+4.75	+5.00	+5.25	Volts
Supply Current:				
Standard Models ④	–	+100	+140	mA
Low-Power Models	–	+35	+50	mA
Display				
Display Type and Size	4½ digit, 0.52"/13.2mm high LED			
Polarity Indication	Autopolarity ("–" for negative Vin)			
Overrange Indication	"–0000" (flashing) for negative Vin "0000" (flashing) for positive Vin			
Physical/Environmental				
Operating Temperature	0	–	+50	°C
Storage Temperature	–20	–	+75	°C

Humidity (non-condensing)	0	–	95	%
Case Material	Polycarbonate			
Weight	0.75 ounces (21 grams)			

- ① Applies for transient or continuous overvoltages applied to (+) INPUT HI (pin 11) with (–) INPUT LO (pin 12) properly connected. Pin 12 is not overvoltage protected (see Figure 1). Voltages applied to pin 12 should not exceed the supply voltage.
- ② See Technical Notes.
- ③ BCD outputs are optional and must be specified in the part number. See Ordering Information.
- ④ Includes high-intensity and BCD-output models.

Ordering Information

DMS-40PC - 1 - RS - C

Input Range:

- 1 = ±2V
- 2 = ±20V
- 3 = ±200V

LED Color:

- GS = Standard Green
- RH = High-Intensity Red
- RL = Low-Power Red
- RS = Standard Red
- YS = Standard Yellow

Add -C for RoHS



BCD Output Models:

BCD outputs are only available on standard red meters.

- DMS-40PC-1-RS-BCD-C for ±2V input range
- DMS-40PC-2-RS-BCD-C for ±20V input range
- DMS-40PC-3-RS-BCD-C for ±200V input range
- DMS-40PC-1-RL-BCD-C for ±2V input range
- DMS-40PC-2-RL-BCD-C for ±20V input range
- DMS-40PC-3-RL-BCD-C for ±200V input range

Accessories:

- DMS-30-CP Panel cutout punch
- DMS-BZL1-C DMS-40 bezel assembly
- DMS-BZL2-C DMS-40 bezel assembly with sealing gasket
- DMS-EB-C Application/evaluation board with standard MOLEX connector, decimal point solder pads and attenuation resistor pads.

A panel-mount retaining clip is supplied with each model.

TECHNICAL NOTES

- 1. ANALOG COMMON (Pin 10):** This pin is an internal, low-noise ground for the DMS-40PC. It is internally connected to pin 3 (5V RETURN). Do not connect pin 10 to either pin 3 or your system ground as this will create a ground loop and possibly result in erroneous readings.
- 2. REFERENCE INPUT/OUTPUT (Pin 7):** This pin accesses the meter's internal reference and is used during the factory calibration procedure. Pin 7 should be left open in most common applications. It can be used in certain "ratiometric" applications in which it is desirable for the meter's reference to track an external reference. See Ap Note 3 in the DATEL Panel Meter Catalog for more details.
- 3. DISPLAY TEST (Pin 2):** Connecting pin 2 to ground (pin 3, 5V RETURN) will activate all LED segments, and the display will read "–18888" regardless of the actual applied input. To reduce self-heating, the display should not be left in the "test" mode for more than 10 seconds. This pin should be left open if unused.

4. DISPLAY HOLD (Pin 9): For normal operation, this pin should be left open. To hold the meter's last reading and display it continuously, tie pin 9 to ground (pin 3, 5V RETURN).

5. Decimal Point Placement: The location of the decimal point is user-selectable, and the decimal point control pins (DP1-DP4) are active low functions. Select the appropriate decimal point by tying pin 4, 5, 6 or 8 to pin 3 (5V RETURN). Unused decimal point location pins should be left open.

Hard wiring is preferable, however, you can exercise dynamic control over the location of the decimal point by employing drive circuits that are capable of sinking a minimum of 20mA at voltages less than +0.4 Volts.

6. Gain Adjust: There is a gain-adjust potentiometer on the back of each meter. It has approximately ±150 counts of adjustment range. Since these meters essentially have no zero/offset errors, a gain adjustment is effectively an overall accuracy adjustment. Though they may be performed at any point (except zero), accuracy adjustments are most effective when performed with higher level input signals.

7. Soldering Methods: All models in the DMS-40PC Series easily withstand most common wave soldering operations. We recommend, however, that you evaluate the effects your particular soldering techniques may have on the meter's plastic case and high-precision electrical performance. We recommend the use of no-clean solders.

8. Suggested Mating Connectors:

Panel mounted:

Connector housing	DATEL P/N 4320-01069-0
Terminal type	DATEL P/N 4400-01032-0
Crimping tool	DATEL P/N 39-2099000
Wire size	22 to 26 AWG
Insulation diameter	0.062" (1.57mm) maximum
Stripping length	0.100 to 0.125" (2.54 to 3.17mm)

Board mounted:

Socket	DATEL P/N 4320-01074-0
--------	------------------------

APPLICATIONS

DMS-40PC Series meters are high-precision versatile devices that can be used in many applications requiring a 0 to 19,999 count digital display. The application circuits chosen for this section are ones that have historically received many inquiries. Every attempt has been made to ensure technical accuracy, and all of the following circuits have been prototyped and tested to ensure functionality. Please keep in mind, however, that real-world applications are seldom as straightforward as the approaches presented here.

All inputs applied to DMS-40PC meters must be steady, dc values, otherwise the input itself may cause display instabilities. Due to their 4½ digit resolution, DMS-40PC meters must be wired with greater care than their 3½ digit counterparts. Correct power-supply and input-signal wiring — an absolute must! — helps eliminate ground-loop induced errors that

show up as unstable display readings. When an input signal, assumed to be exactly zero volts, has a 1mV (0.001V) ground-loop induced offset, it is displayed as "0010" on a ±2V input-range meter! DATEL's new Digital Panel Meter Catalog contains an application note describing power supply wiring and ground loop avoidance techniques.

The DMS-40PC's simplified schematic, shown in Figure 1, can be very useful when debugging a malfunctioning circuit, especially if the user has some knowledge of operational amplifiers (op amps). The meter's high-impedance input consists of an op amp powered from a ±5Vdc power supply (the -5V is internally generated). Figure 1 shows that input signals applied to (-) INPUT LO and (+) INPUT HI must be kept within the ±5V power-supply rails. Also note that only pin 11 has a current-limiting 909kΩ series resistor. High input voltages that have a common ground connection with pin 3 (5V RETURN) should only be applied to pin 11 ((+) INPUT HI) and never to pin 12. In these high-voltage cases, pin 12 should always be tied to pin 3 (5V RETURN).

One of the simplified schematic's more noteworthy features is that it shows some DMS-40PC internal voltage values and also that pin 3 is the meter's zero-volt reference point — regardless of the type of power or signal source used. This is an important point to keep in mind when using digital multimeters to perform system-level measurements. The multimeter's negative lead (usually the black one) must always be connected to pin 3 (5V RETURN). This is the only way accurate readings can be made, particularly if the meter is configured for a differential input and concerns arise regarding common-mode voltages.

1. Single-Ended Input Configurations: The DMS-40PC can measure single-ended signals with either positive or negative polarities. True single-ended inputs always have one of their two terminals at the same potential as the DMS-40PC's 5V RETURN (pin 3). Single-ended inputs are usually derived from power supplies that have a common ground with the meter's +5V supply. Figure 2 shows the recommended connections to be used with this type of input. Pin 12, (-) INPUT LO, is shown directly tied to ground. This connection to ground must be a separate wire or pc-board trace originating at V_M 's negative terminal. This hook-up will normally eliminate display instabilities and errors caused by ground-loop currents which can occur if (-) INPUT LO is tied to ground at, or near, pin 3.

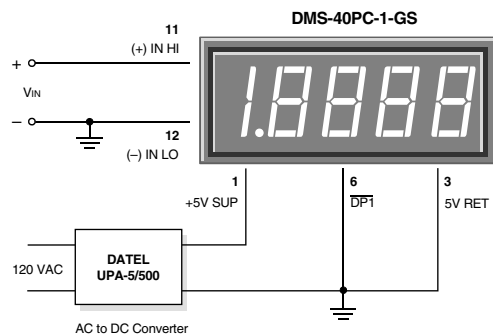

Figure 2. Single-Ended Input Configuration

APPLICATIONS

2. Differential Input Configurations: Differential inputs can also be measured with DMS-40PC meters as shown in the circuit of Figure 3. Differential inputs must also originate from power supplies that have a common ground with the meter's 5V RETURN (pin 3). However, differential inputs usually have both terminals above and/or below 5V RETURN. Figure 3, though not necessarily a typical real-world application, does serve the purpose of illustrating the concept of a differential signal.

The voltages developed across R1, R2 and R3 are equal to each other and measure approximately +1.666Vdc or 1/3 of the +5V power source. More importantly, while the signal across R3 is single-ended, both ends of R1 and R2 are well above ground and are described here as being differential. Please note that while the DMS-40PC can measure the voltages across either R2 or R3, it cannot measure the +1.666 volts across R1! The voltage at the lower end of R1 is approximately 3.333V and this exceeds the common mode voltage limit of ±2V.

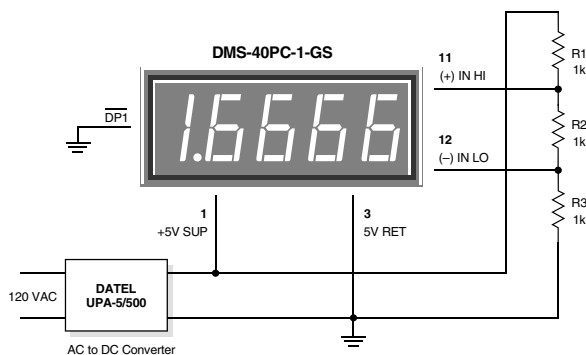

Figure 3. Differential Input Configuration

3. Power Supply Monitoring: One of the most widely used digital panel voltmeter applications is monitoring the output voltage of a system power supply — often the same supply that also powers the meter. The low-power, red LED DMS-40PC-2-RL, with its excellent 0.001Vdc resolution, can be configured to monitor power supplies with outputs in the range of 4.5-18Vdc. The circuit in Figure 4 uses a low-drop-out, three-terminal regulator (LM-2931T-5, in a T0-220 package, available from National Semiconductor) to provide regulated 5V power to the meter.

The LM-2931 was chosen because it has the following on-chip protection features: reverse polarity, short circuit and thermal runaway. The DMS-40PC-3-RL can monitor voltages up to ±200Vdc, provided a separate +5V power source is used since many three-terminal regulators cannot operate with supply voltages greater than 24V. Red, low-power LED models, with their very low self-heating, are recommended for applications in which low calibration drift is desirable.

When using other, higher-power, DMS-40PC models in combination with three-terminal regulators, be sure to consult the regulator manufacturer's data sheet to ensure the device is being utilized safely and correctly.

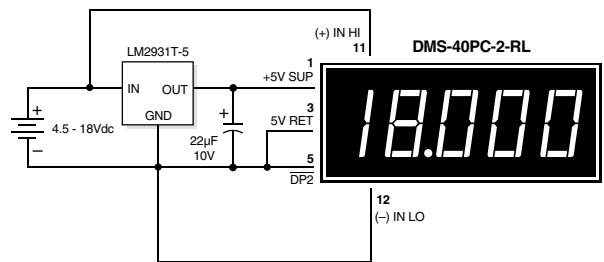

Figure 4. 4.5-18V Power Supply Monitor

4. Floating Signal Source Measurements: A floating input is a signal that, before it is applied to the DMS-40PC's inputs, has no galvanic connection (direct current path) to the meter or the meter's power supply. The circuit shown in Figure 5 illustrates the necessary connections for measuring floating inputs. The 1.5V battery represents a true floating input signal since it initially has no connection whatsoever in common with the meter. Real-world floating inputs typically originate from power supplies which are transformer isolated from the DMS-40PC's +5V supply.

The connection of pin 12 ((-) INPUT LO) to pin 10 (ANALOG COMMON) is required in order to provide a bias return for the meter's input amplifier. This is because neither pin 11 nor pin 12 are tied to any reference voltage inside the DMS-40PC (see Figure 1). These connections are not made internally in order to give the meter the ability to make differential measurements as described in a previous section.

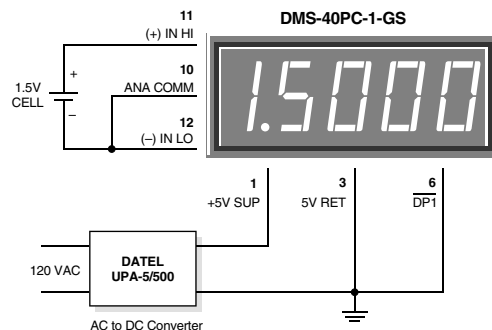

Figure 5. Floating Input Measurements

APPLICATIONS

5. Engineering Scaling and Input Attenuation: In many applications, the input signal must be scaled, or divided down, before being applied to the DMS-40PC. In some situations, the input signal exceeds the full-scale range of the meter, and in other applications, a direct one-to-one relation does not exist between the input voltage and the desired display reading. For an example of the second situation, assume an input voltage of 1.0Vdc is required to display a reading of “7500” when applied to a ±2V input meter. An input divider circuit, constructed with two series resistors with an output-to-input ratio of 0.75, will scale the 1.0V signal down to 0.75V.

Engineering scaling and input attenuation are discussed in Ap Note 4 of the DATEL Digital Panel Voltmeter Catalog. Compensating for inputs which have a zero offset is also discussed.

6. BCD Outputs (DMS-40PC-X-RS and -RL-BCD Models Only):

Models with a “-BCD” suffix have 12 extra output pins, labeled A through L (6 per side), that provide the following information: multiplexed serial BCD data, digit drive, and polarity indication. The data present on pins A - L simultaneously drives the meter’s internal LED display. All functions on pins A - L are 5V CMOS compatible, however, they are only rated to drive one, 74LS series, TTL load. CMOS logic IC’s, for example 74HC or 74HCT series devices, should be used when more fan-out capability is required.

As the timing diagram in Figure 5 indicates, 100Hz is the optimum display scan rate when the BCD outputs are used to drive external LED displays. Faster scan rates, while permissible, are not necessary. Slower scanning, however, may result in noticeable “flickering” of the display. Common anode LED’s, combined with a 74LS247 BCD to seven-segment decoder, is the simplest way of implementing an

external display. A seventy-five to one-hundred Ohm resistor on each LS247 segment-drive output provides adequate display brightness.

The functions of pins A - L are listed below:

BCD DATA (pins I - L): Four lines are used for BCD (Binary Coded Decimal) data outputs, representing the numbers 0 - 9. Positive-logic convention (a high represents a “1”) is used.

DIGIT DRIVE (pins A - E): These five outputs, when gated with STROBE, can be used to direct the BCD DATA into external latches. DIGIT DRIVE outputs may also be connected directly to the bases of NPN transistors in remote-display configurations. The digits are scanned right-to-left, i.e., MSD (DIGIT 1 DRIVE) to LSD (DIGIT 5 DRIVE).

BUSY (pin G): This is a status pin that goes high at the start of an analog-to-digital (A/D) conversion cycle and remains high until the conversion ends.

STROBE (pin H): A string of five sequential, active-low, STROBE pulses are output (after BUSY goes low) indicating the end of a conversion and the availability of new data. The 5 STROBE pulses occur only once per conversion, or 2.5 times each second. STROBE can be used to latch the BCD data (on pins I - L) into external latches. Either edge can be used since STROBE (~ 5µsec wide) is active only in the center of the corresponding DIGIT DRIVE and BCD DATA outputs.

POLARITY (pin F): This pin, which is also used inside the DMS-40PC to drive the negative-sign segment, indicates whether the last input signal conversion was positive (POLARITY set high) or negative (POLARITY set low). POLARITY, unlike BCD DATA, is not multiplexed. For data latching purposes, POLARITY should be sampled during the STROBE pulse for digit 1 (most significant digit).

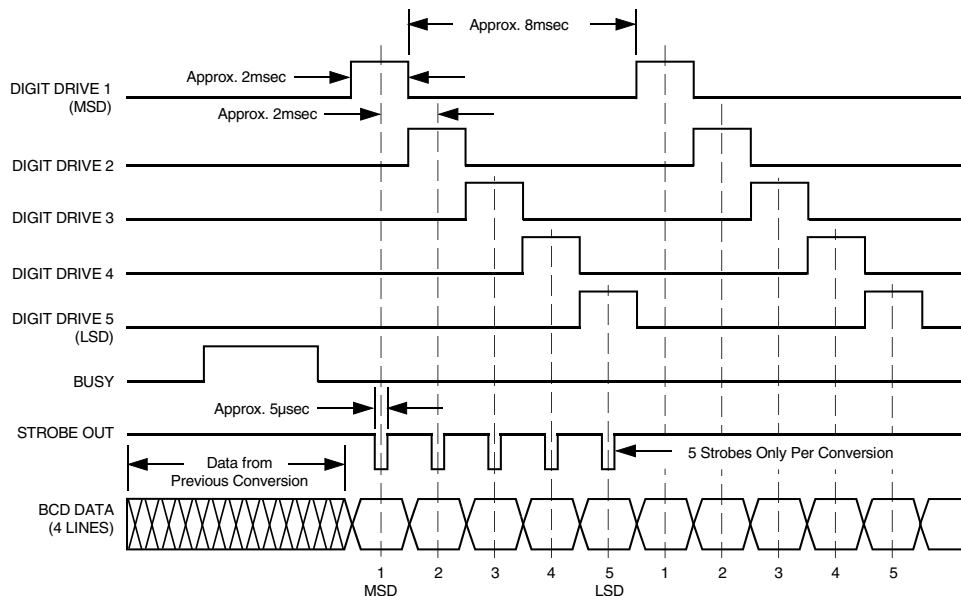

Figure 6. BCD Data Timing Diagram

MECHANICAL DIMENSIONS: Inches (mm)
 TOLERANCES: 2 PL DEC ±0.02 (±0.51)
 3 PL DEC ±0.010 (±0.254)
 LEAD DIMENSIONS: 0.025 (0.635) x 0.025 (0.635) NOMINAL
 RECOMMENDED PC BOARD FINISHED HOLE DIAMETER:
 0.042 ±0.003 (1.067 ±0.076)

