



Metallized Polypropylene (MKP/MFP)

Series/Type: **B32682**

The following products presented in this data sheet are being withdrawn.

Ordering Code	Substitute Product	Date of Withdrawal	Deadline Last Orders	Last Shipments
B32682		06.09.2002	31.10.2002	31.03.2003
B32683		06.09.2002	31.10.2002	31.03.2003
B32684		06.09.2002	31.10.2002	31.03.2003

For further information please contact your nearest EPCOS sales office, which will also support you in selecting a suitable substitute. The addresses of our worldwide sales network are presented at www.epcos.com/sales.

**Wound MFP pulse capacitors
with highest possible contact reliability**
Construction

- Dielectric: polypropylene
- Film metallized on one side and metal foils internally connected in series
- Plastic case (UL 94 V-0)
- Epoxy resin sealing

Features

- Very high pulse strength
- Highest possible contact reliability
- Self-healing properties

Typical applications

- Pulse circuits with steep voltage rise rates
- High-frequency ac loads
- Snubbing of power semiconductors

Terminals

- Parallel wire leads, tinned
- Also available with $(3,2 \pm 0,3)$ mm lead length

Marking

Manufacturer's logo,
lot number
style (MFP),
rated capacitance (coded),
capacitance tolerance (code letter),
rated dc voltage,
date of manufacture (coded)

Delivery mode

Bulk (untaped)

Taped (Ammo pack or reels)

For notes on taping, refer to chapter "Taping and packing", page 274.

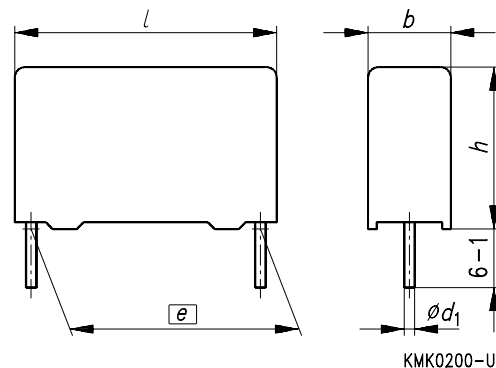

Dimensions in mm

Lead spacing $e \pm 0,4$	Diameter d_1	Type
15,0	0,8	B 32 682
22,5	0,8	B 32 683
27,5	0,8	B 32 684
37,5	1,0	B 32 686

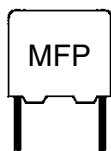
B 32 682 ...
B 32 686
Overview of available types

Lead spacing	15 mm					22,5 mm							
Type	B 32 682					B 32 683							
Page	181					182							
0,10 nF					2000 Vdc 500 Vac								
0,15 nF													
0,22 nF													
0,33 nF													
0,47 nF													
0,68 nF													
1,0 nF													
1,5 nF													
2,2 nF				1600 Vdc 450 Vac									
3,3 nF		1000 Vdc 400 Vac	1250 Vdc 450 Vac							2000 Vdc 500 Vac			
4,7 nF	630 Vdc 300 Vac	1000 Vdc 400 Vac	1250 Vdc 450 Vac	1600 Vdc 450 Vac	2000 Vdc 500 Vac								
6,8 nF													
10 nF													
15 nF													
22 nF						1000 Vdc 400 Vac	1250 Vdc 450 Vac	1600 Vdc 450 Vac					
33 nF													
47 nF						630 Vdc 300 Vac	1000 Vdc 400 Vac	1250 Vdc 450 Vac	1600 Vdc 450 Vac	2000 Vdc 500 Vac			
68 nF													
0,10 µF													
0,15 µF													

Lead spacing	27,5 mm					37,5 mm									
Type	B 32 684					B 32 686									
Page	183					184									
15 nF					2000 Vdc 500 Vac										
22 nF															
33 nF															
47 nF				1600 Vdc 450 Vac											
68 nF		1000 Vdc 400 Vac	1250 Vdc 450 Vac						2000 Vdc 500 Vac						
0,10 µF															
0,15 µF	630 Vdc 300 Vac	1000 Vdc 400 Vac	1250 Vdc 450 Vac	1600 Vdc 450 Vac	2000 Vdc 500 Vac										
0,22 µF										1000 Vdc 400 Vac	1250 Vdc 450 Vac	1600 Vdc 450 Vac			
0,33 µF															
0,47 µF															

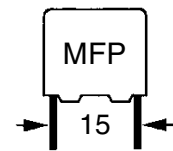
Ordering codes and packing units, lead spacing 15 mm

V_R (V_{rms} , $f \leq 1$ kHz)	C_R	Maximum dimensions $b \times h \times l$ (mm)	Ordering code ¹⁾	Packing units (pcs)		
				Ammo pack	Reel	Untaped
630 Vdc (300 Vac)	4,7 nF	5,0 × 10,5 × 18,0	B32682-A6472-+***	1170	1300	1000
	6,8 nF	5,0 × 10,5 × 18,0	B32682-A6682-+***	1170	1300	1000
	10 nF	5,0 × 10,5 × 18,0	B32682-A6103-+***	1170	1300	1000
	15 nF	6,0 × 11,0 × 18,0	B32682-A6153-+***	960	1100	1000
	22 nF	7,0 × 12,5 × 18,0	B32682-A6223-+***	830	900	1000
	33 nF	8,5 × 14,5 × 18,0	B32682-A6333-+***	680	700	500
	47 nF	9,0 × 17,5 × 18,0	B32682-A6473-+***	640	700	500
1000 Vdc (400 Vac)	3,3 nF	5,0 × 10,5 × 18,0	B32682-A332-+***	1170	1300	1000
	4,7 nF	6,0 × 11,0 × 18,0	B32682-A472-+***	960	1100	1000
	6,8 nF	7,0 × 12,5 × 18,0	B32682-A682-+***	830	900	1000
	10 nF	8,5 × 14,5 × 18,0	B32682-A103-+***	680	700	500
	15 nF	9,0 × 17,5 × 18,0	B32682-A153-+***	640	700	500
1250 Vdc (450 Vac)	2,2 nF	5,0 × 10,5 × 18,0	B32682-A7222-+***	1170	1300	1000
	3,3 nF	6,0 × 11,0 × 18,0	B32682-A7332-+***	960	1100	1000
	4,7 nF	7,0 × 12,5 × 18,0	B32682-A7472-+***	830	900	1000
	6,8 nF	8,5 × 14,5 × 18,0	B32682-A7682-+***	680	700	500
	10 nF	9,0 × 17,5 × 18,0	B32682-A7103-+***	640	700	500
1600 Vdc (450 Vac)	1,5 nF	5,0 × 10,5 × 18,0	B32682-A1152-+***	1170	1300	1000
	2,2 nF	6,0 × 11,0 × 18,0	B32682-A1222-+***	960	1100	1000
	3,3 nF	7,0 × 12,5 × 18,0	B32682-A1332-+***	830	900	1000
	4,7 nF	8,5 × 14,5 × 18,0	B32682-A1472-+***	680	700	500
	6,8 nF	9,0 × 17,5 × 18,0	B32682-A1682-+***	640	700	500
2000 Vdc (500 Vac)	0,10 nF	5,0 × 10,5 × 18,0	B32682-A2101-+***	1170	1300	1000
	0,15 nF	5,0 × 10,5 × 18,0	B32682-A2151-+***	1170	1300	1000
	0,22 nF	5,0 × 10,5 × 18,0	B32682-A2221-+***	1170	1300	1000
	0,33 nF	5,0 × 10,5 × 18,0	B32682-A2331-+***	1170	1300	1000
	0,47 nF	5,0 × 10,5 × 18,0	B32682-A2471-+***	1170	1300	1000
	0,68 nF	5,0 × 10,5 × 18,0	B32682-A2681-+***	1170	1300	1000
	1,0 nF	5,0 × 10,5 × 18,0	B32682-A2102-+***	1170	1300	1000
	1,5 nF	6,0 × 11,0 × 18,0	B32682-A2152-+***	960	1100	1000
	2,2 nF	7,0 × 12,5 × 18,0	B32682-A2222-+***	830	900	1000
	3,3 nF	8,5 × 14,5 × 18,0	B32682-A2332-+***	680	700	500
	4,7 nF	9,0 × 17,5 × 18,0	B32682-A2472-+***	640	700	500

Capacitance tolerance: $\pm 10\% \hat{=} K, \pm 5\% \hat{=} J, (\pm 3,5\% \text{ upon request})$

1) + Code letter for capacitance tolerance

*** Code number for packing: Ammo pack = 289, reel = 189

The ordering code for untaped components ends after the tolerance code letter.

For capacitors with 3,2 mm lead length, append code number "3" to the tolerance code, e.g.: B32682-A6472-K3

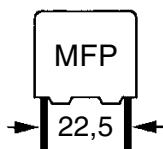
B 32 683
Ordering codes and packing units, lead spacing 22,5 mm

V_R (V_{rms} , $f \leq 1$ kHz)	C_R	Maximum dimensions $b \times h \times l$ (mm)	Ordering code ¹⁾	Packing units (pcs)		
				Ammo pack	Reel	Untaped
630 Vdc (300 Vac)	33 nF	6,0 × 15,0 × 26,5	B32683-A6333-+***	680	700	720
	47 nF	7,0 × 16,0 × 26,5	B32683-A6473-+***	580	600	630
	68 nF	8,5 × 16,5 × 26,5	B32683-A6683-+***	480	500	510
	0,10 µF	10,5 × 16,5 × 26,5	B32683-A6104-+***	390	400	540
	0,15 µF	11,0 × 20,5 × 26,5	B32683-A6154-+***	370	350	510
1000 Vdc (400 Vac)	10 nF	6,0 × 15,0 × 26,5	B32683-A103-+***	680	700	720
	15 nF	6,0 × 15,0 × 26,5	B32683-A153-+***	680	700	720
	22 nF	7,0 × 16,0 × 26,5	B32683-A223-+***	580	600	630
	33 nF	8,5 × 16,5 × 26,5	B32683-A333-+***	480	500	510
	47 nF	10,5 × 18,5 × 26,5	B32683-A473-+***	390	400	540
1250 Vdc (450 Vac)	10 nF	6,0 × 15,0 × 26,5	B32683-A7103-+***	680	700	720
	15 nF	7,0 × 16,0 × 26,5	B32683-A7153-+***	580	600	630
	22 nF	8,5 × 16,5 × 26,5	B32683-A7223-+***	480	500	510
	33 nF	10,5 × 18,5 × 26,5	B32683-A7333-+***	390	400	540
1600 Vdc (450 Vac)	6,8 nF	6,0 × 15,0 × 26,5	B32683-A1682-+***	680	700	720
	10 nF	7,0 × 16,0 × 26,5	B32683-A1103-+***	580	600	630
	15 nF	8,5 × 16,5 × 26,5	B32683-A1153-+***	480	500	510
	22 nF	10,5 × 18,5 × 26,5	B32683-A1223-+***	390	400	540
2000 Vdc (500 Vac)	2,2 nF	6,0 × 15,0 × 26,5	B32683-A2222-+***	680	700	720
	3,3 nF	6,0 × 15,0 × 26,5	B32683-A2332-+***	680	700	720
	4,7 nF	7,0 × 16,0 × 26,5	B32683-A2472-+***	580	600	630
	6,8 nF	8,5 × 16,5 × 26,5	B32683-A2682-+***	480	500	510
	10 nF	10,5 × 16,5 × 26,5	B32683-A2103-+***	390	400	540
	15 nF	11,0 × 20,5 × 26,5	B32683-A2153-+***	370	350	510

 Capacitance tolerance: $\pm 10\% \hat{=} K$, $\pm 5\% \hat{=} J$, ($\pm 3,5\%$ upon request)

1) + Code letter for capacitance tolerance

*** Code number for the packing: Ammo pack = 289, reel = 189

The ordering code for untaped components ends after the tolerance code letter.

For capacitors with 3,2 mm lead length, append code number "3" to the tolerance code, e.g.: B32683-A6154-K3

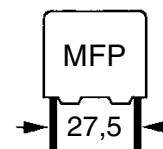
Ordering codes and packing units, lead spacing 27,5 mm

V_R (V_{rms} , $f \leq 1$ kHz)	C_R	Maximum dimensions $b \times h \times l$ (mm)	Ordering code ¹⁾	Packing units (pcs)		
				Ammo pack	Reel	Untaped
630 Vdc (300 Vac)	0,15 μ F	11,0 \times 21,0 \times 31,5	B32684-A6154-+***	–	350	320
	0,22 μ F	12,5 \times 21,5 \times 31,5	B32684-A6224-+***	–	300	280
	0,33 μ F	15,0 \times 24,5 \times 31,5	B32684-A6334-+	–	–	240
	0,47 μ F	18,0 \times 27,5 \times 31,5	B32684-A6474-+	–	–	200
1000 Vdc (400 Vac)	68 nF	11,0 \times 21,0 \times 31,5	B32684-A683-+***	–	350	320
	0,10 μ F	12,5 \times 21,5 \times 31,5	B32684-A104-+***	–	300	280
	0,15 μ F	18,0 \times 27,5 \times 31,5	B32684-A154-+	–	–	200
1250 Vdc (450 Vac)	47 nF	11,0 \times 21,0 \times 31,5	B32684-A7473-+***	–	350	320
	68 nF	13,5 \times 23,0 \times 31,5	B32684-A7683-+***	–	250	260
	0,10 μ F	15,0 \times 24,5 \times 31,5	B32684-A7104-+	–	–	240
	0,15 μ F	19,0 \times 30,0 \times 31,5	B32684-A7154-+	–	–	180
1600 Vdc (450 Vac)	33 nF	11,0 \times 21,0 \times 31,5	B32684-A1333-+***	–	350	320
	47 nF	12,5 \times 21,5 \times 31,5	B32684-A1473-+***	–	300	280
	68 nF	15,0 \times 24,5 \times 31,5	B32684-A1683-+	–	–	240
	0,10 μ F	19,0 \times 30,0 \times 31,5	B32684-A1104-+	–	–	180
2000 Vdc (500 Vac)	15 nF	11,0 \times 21,0 \times 31,5	B32684-A2153-+***	–	350	320
	22 nF	11,0 \times 21,0 \times 31,5	B32684-A2223-+***	–	350	320
	33 nF	14,0 \times 24,5 \times 31,5	B32684-A2333-+	–	–	260
	47 nF	18,0 \times 27,5 \times 31,5	B32684-A2473-+	–	–	200

Capacitance tolerance: $\pm 10\% \hat{=} K, \pm 5\% \hat{=} J, (\pm 3,5\% \text{ upon request})$

1) + Code letter for capacitance tolerance

*** Code number for packing: Reel = 189

The ordering code for untaped components ends after the tolerance code letter.

For capacitors with 3,2 mm lead length, append code number "3" to the tolerance code, e.g.: B32684-A6154-K3

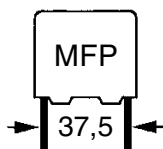

B 32 686

Ordering codes and packing units, lead spacing 37,5 mm

V_R (V_{rms} $f < 60$ kHz)	C_R	Maximum dimensions $b \times h \times l$ (mm)	Ordering code ¹⁾	Packing units (pcs) Untaped
1000 Vdc (400 Vac)	0,10 μ F	12,0 \times 22,0 \times 41,5	B32686-A104-+	72
	0,15 μ F	14,0 \times 25,0 \times 41,5	B32686-A154-+	56
	0,22 μ F	16,0 \times 28,5 \times 41,5	B32686-A224-+	48
	0,33 μ F	20,0 \times 39,5 \times 41,5	B32686-A334-+	32
	0,47 μ F	20,0 \times 39,5 \times 41,5	B32686-A474-+	32
1250 Vdc (450 Vac)	68 nF	12,0 \times 22,0 \times 41,5	B32686-A7683-+	72
	0,10 μ F	14,0 \times 25,0 \times 41,5	B32686-A7104-+	56
	0,15 μ F	16,0 \times 28,5 \times 41,5	B32686-A7154-+	48
	0,22 μ F	18,0 \times 32,5 \times 41,5	B32686-A7224-+	48
	0,33 μ F	20,0 \times 39,5 \times 41,5	B32686-A7334-+	32
1600 Vdc (450 Vac)	47 nF	12,0 \times 22,0 \times 41,5	B32686-A1473-+	72
	68 nF	14,0 \times 25,0 \times 41,5	B32686-A1683-+	56
	0,10 μ F	18,0 \times 32,5 \times 41,5	B32686-A1104-+	48
	0,15 μ F	20,0 \times 39,5 \times 41,5	B32686-A1154-+	32
2000 Vdc (500 Vac)	22 nF	12,0 \times 22,0 \times 41,5	B32686-A2223-+	72
	33 nF	14,0 \times 25,0 \times 41,5	B32686-A2333-+	56
	47 nF	16,0 \times 28,5 \times 41,5	B32686-A2473-+	48
	68 nF	18,0 \times 32,5 \times 41,5	B32686-A2683-+	48
	0,10 μ F	20,0 \times 39,5 \times 41,5	B32686-A2104-+	32

Capacitance tolerance: $\pm 20\%$ $\hat{=}$ M, $\pm 10\%$ $\hat{=}$ K, $\pm 5\%$ $\hat{=}$ J, $\pm 5\%$

1) + Code letter for capacitance tolerance

For capacitors with 3,2 mm lead length, append code number "3" to the tolerance code, e.g.: B32686-A104-K3

Technical data

Climatic category in accordance with IEC 60068-1	55/100/56		
Lower category temperature T_{\min}	– 55 °C		
Upper category temperature T_{\max}	+ 100 °C		
Damp heat test	56 days/40 °C/93 % relative humidity		
Limit values after damp heat test	Capacitance change $ \Delta C/C $	$\leq 2 \%$	
	Dissipation factor change $\Delta \tan \delta$	$\leq 1,0 \cdot 10^{-3}$ (at 10 kHz)	
	Insulation resistance R_{is}	$\geq 50 \%$ of minimum	
	or time constant $\tau = C_R \cdot R_{is}$	as-delivered values	
Reliability:			
Reference conditions	0,5 · V_R ; 40 °C		
Failure rate	$1 \cdot 10^{-9}/h = 1$ fit		
Service life	200 000 h		
Failure criteria:			
Total failure	Short circuit or open circuit		
Failure due to variation of parameters	Capacitance change $ \Delta C/C $	$> 10 \%$	
	Dissipation factor $\tan \delta$	4 · upper limit values	
	Insulation resistance R_{is}	$< 1500 \text{ M}\Omega$ ($C_R \leq 0,33\mu\text{F}$)	
	or time constant $\tau = C_R \cdot R_{is}$	$< 500 \text{ s}$ ($C_R > 0,33\mu\text{F}$)	
DC test voltage	$2,0 \cdot V_R$, 2 s		
Category voltage V_C	$T \leq 85 \text{ °C}$: $V_C = 1,0 \cdot V_R$ or $1,0 \cdot V_{\text{rms}}$		
Operation with dc voltage or ac voltage V_{rms} up to 1 kHz			
Dissipation factor $\tan \delta$ (in 10^{-3}) at 20 °C (upper limit values)		$C_R \leq 0,1 \mu\text{F}$	$C_R > 0,1 \mu\text{F}$
	at 1 kHz	–	0,4
	10 kHz	0,4	0,5
	100 kHz	1,0	–
Insulation resistance R_{is} or time constant $\tau = C_R \cdot R_{is}$ at 20 °C, rel. humidity $\leq 65 \%$ (minimum as-delivered values)	$C_R \leq 0,33 \mu\text{F}$	$C_R > 0,33 \mu\text{F}$	
	100 G Ω	30 000 s	

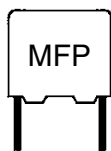

B 32 682 ...

B 32 686

Impedance Z
versus
frequency f
(typical values)

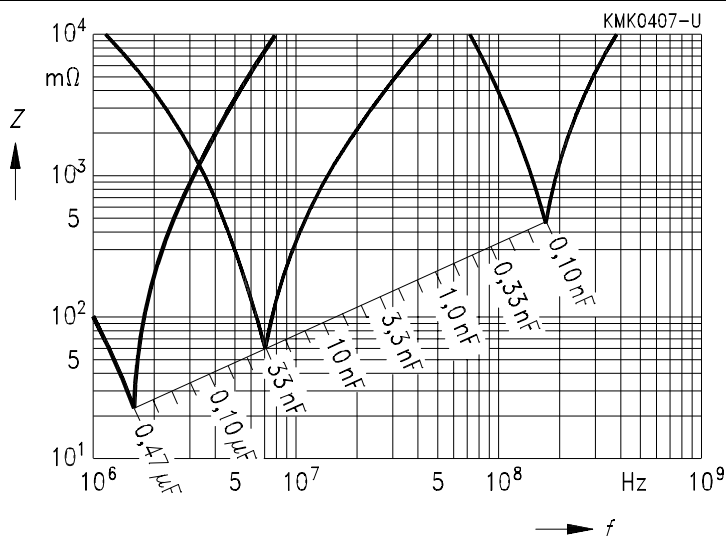

Pulse handling capability

Maximum permissible voltage change per unit of time for non-sinusoidal voltages
(pulse, sawtooth)

V_R	Max. rate of voltage rise V_{pp}/τ in $V/\mu s$ (for $V_{pp} = V_R$)			
	Lead spacing			
	15 mm	22,5 mm	27,5 mm	37,5 mm
630 Vdc	5 000	3 000	2 000	—
1000 Vdc	9 000	5 000	3 800	2 000
1250 Vdc	12 000	7 000	4 500	2 800
1600 Vdc	16 000	11 000	6 000	3 500
2000 Vdc	17 000	15 000	8 000	4 500

For $V_{pp} < V_R$, the permissible voltage rise rate value V_{pp}/τ may be multiplied by the factor V_R/V_{pp} . Also refer to the calculation example in chapter "General technical information", page 302.

V_R	Pulse characteristic k_0 in $V^2/\mu s$ (for $V_{pp} \leq V_R$)			
	Lead spacing			
	15 mm	22,5 mm	27,5 mm	37,5 mm
630 Vdc	6 300 000	3 800 000	2 500 000	—
1000 Vdc	18 000 000	10 000 000	7 500 000	4 000 000
1250 Vdc	30 000 000	17 500 000	11 000 000	7 000 000
1600 Vdc	51 000 000	35 000 000	19 000 000	11 000 000
2000 Vdc	68 000 000	60 000 000	32 000 000	18 000 000

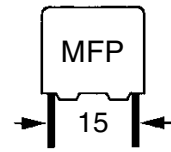

Permissible ac voltage V_{rms} versus frequency f

Lead spacing 15 mm

630 Vdc/ 300 Vac

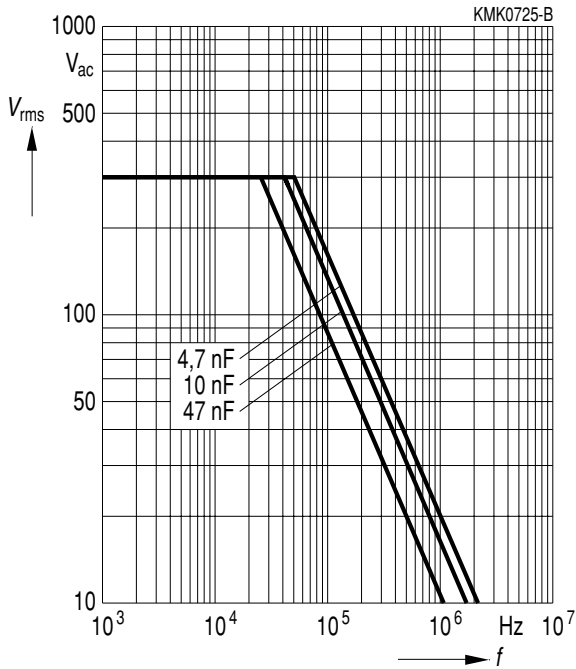

1000 Vdc/ 400 Vac

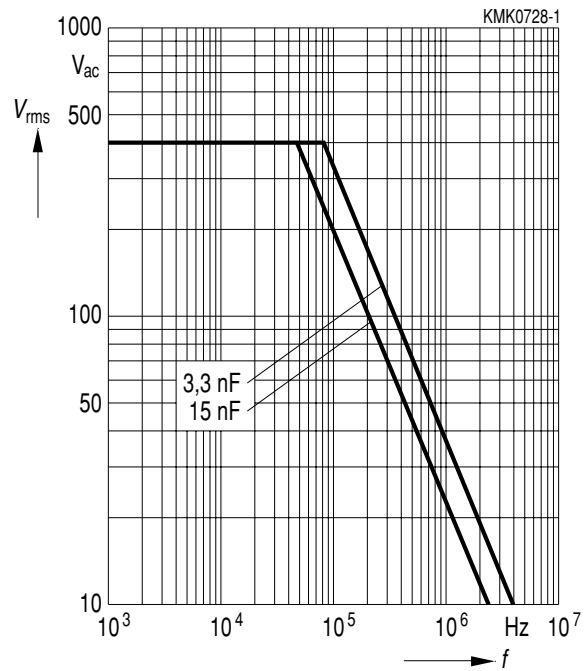

1250 Vdc/ 450 Vac

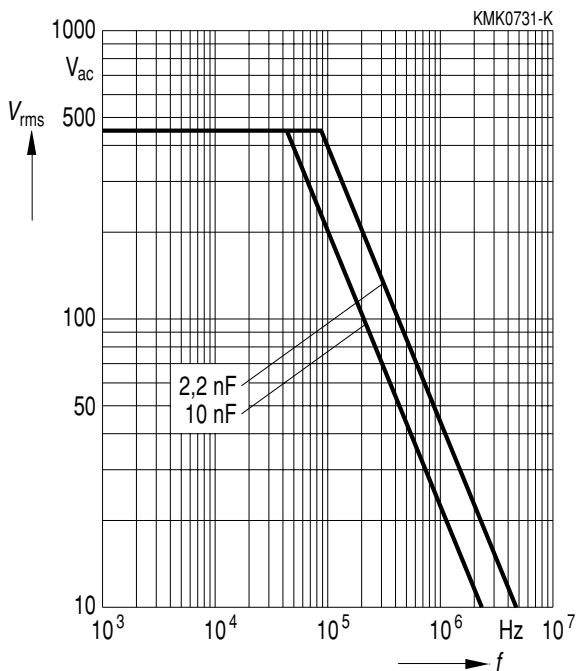

1600 Vdc/ 450 Vac

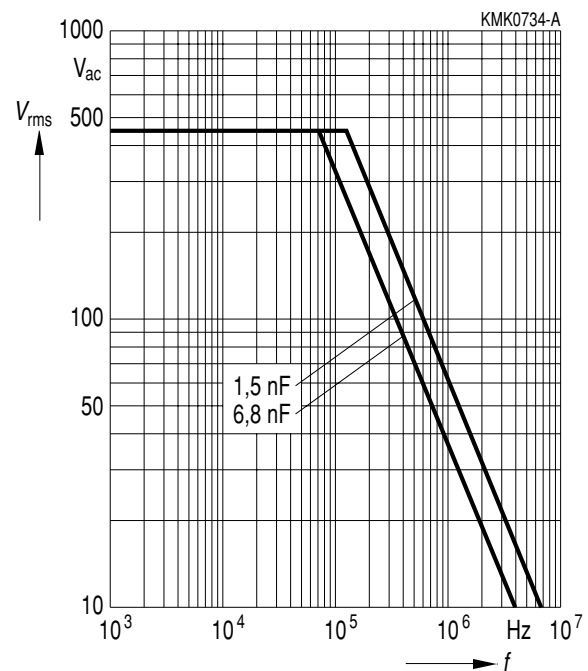

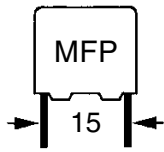

B 32 682 ...

B 32 684

Permissible ac voltage V_{rms} versus frequency f

Lead spacing 15 mm

2000 Vdc/ 500 Vac

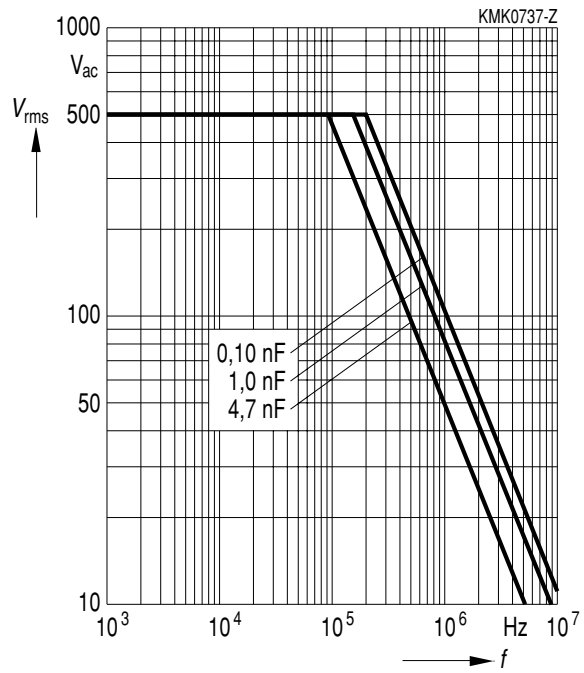

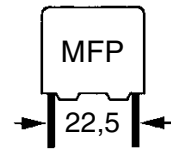

Permissible ac voltage V_{rms} versus frequency f

Lead spacing 22,5 mm

630 Vdc/ 300 Vac

1000 Vdc/ 400 Vac

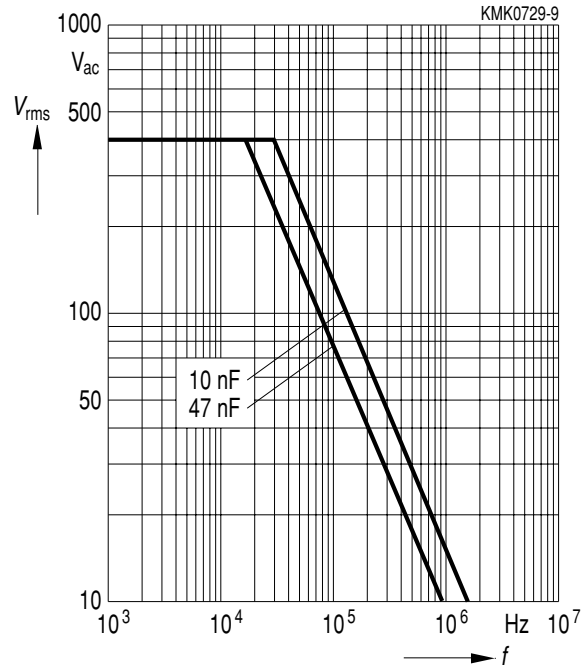
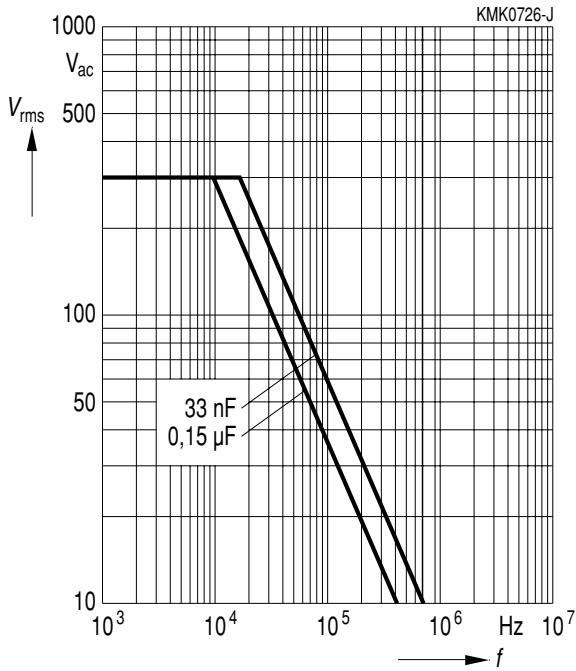

1250 Vdc/ 450 Vac

1600 Vdc/ 450 Vac

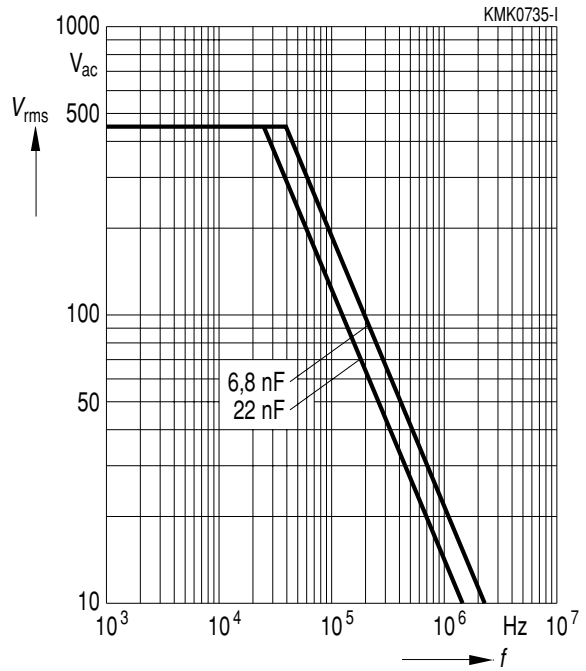
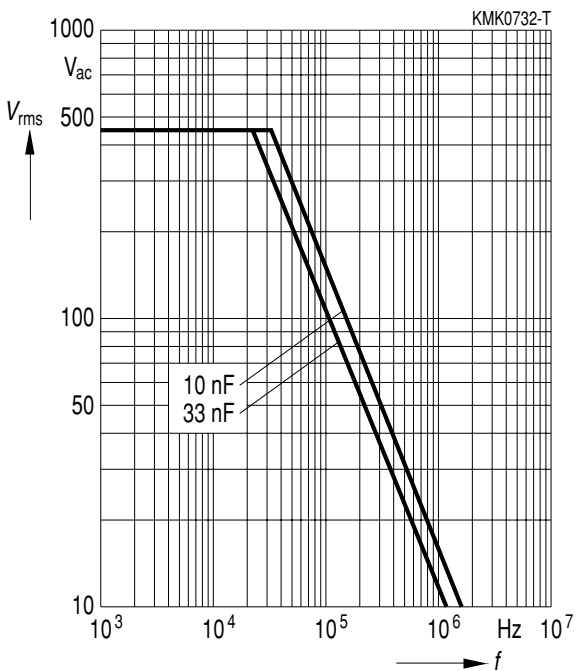

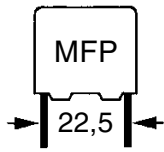

B 32 683

Permissible ac voltage V_{rms} versus frequency f

Lead spacing 22,5 mm

2000 Vdc/ 500 Vac

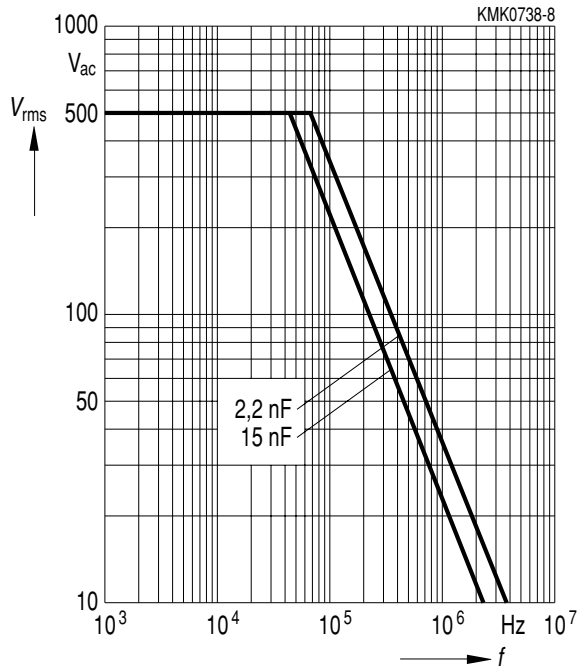

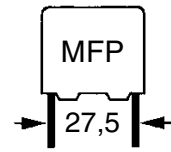

Permissible ac voltage V_{rms} versus frequency f

Lead spacing 27,5 mm

630 Vdc/ 300 Vac

1000 Vdc/ 400 Vac

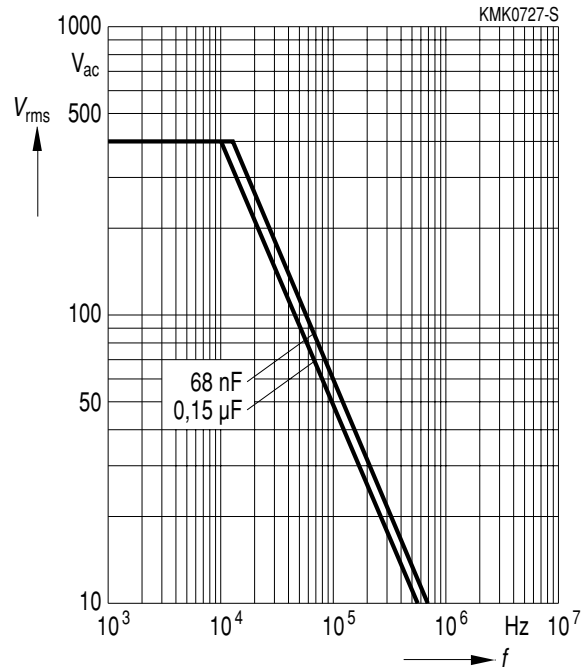
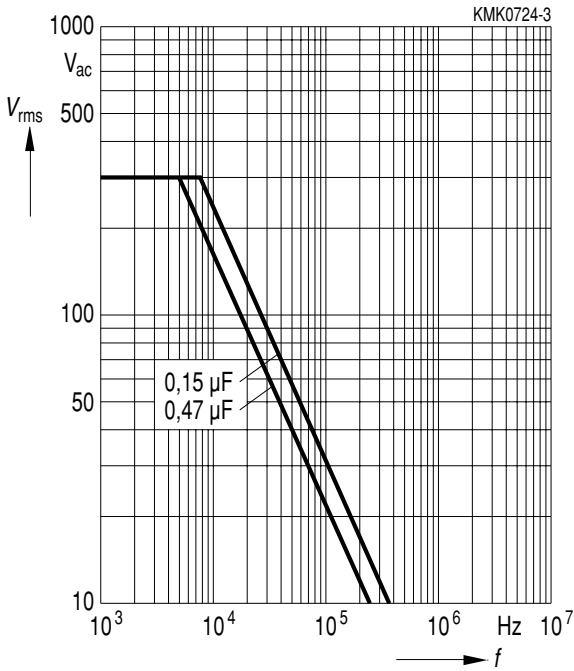

1250 Vdc/ 450 Vac

1600 Vdc/ 450 Vac

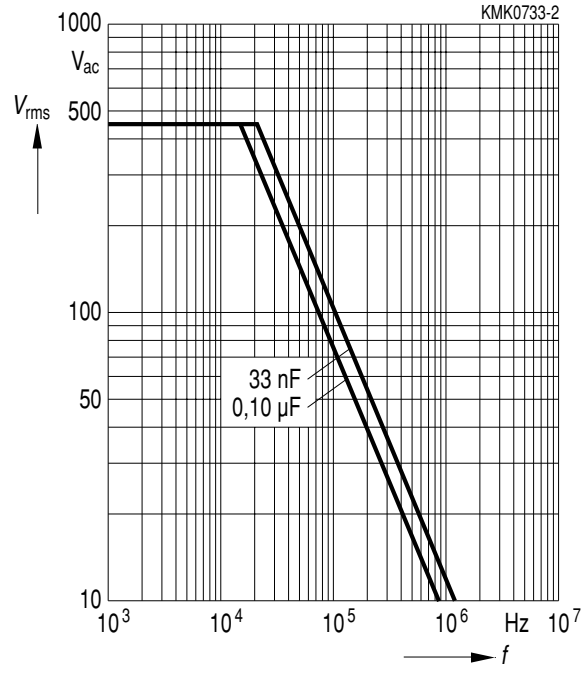
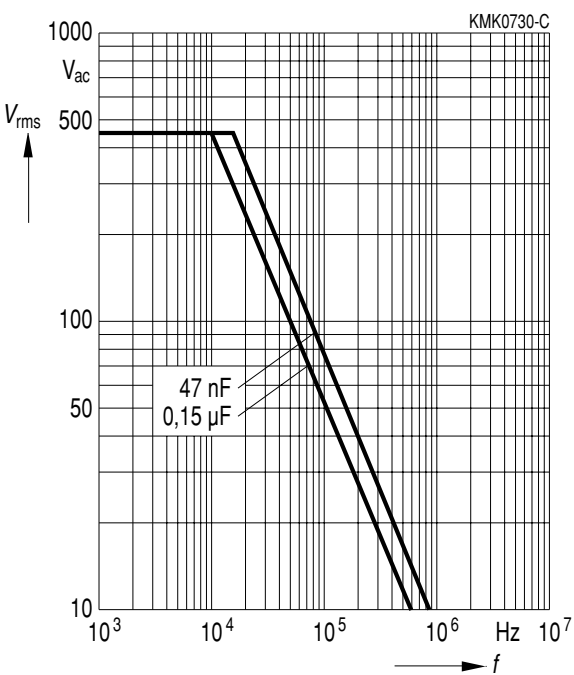

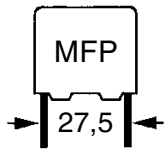

B 32 684

Permissible ac voltage V_{rms} versus frequency f

Lead spacing 27,5 mm

2000 Vdc/ 500 Vac

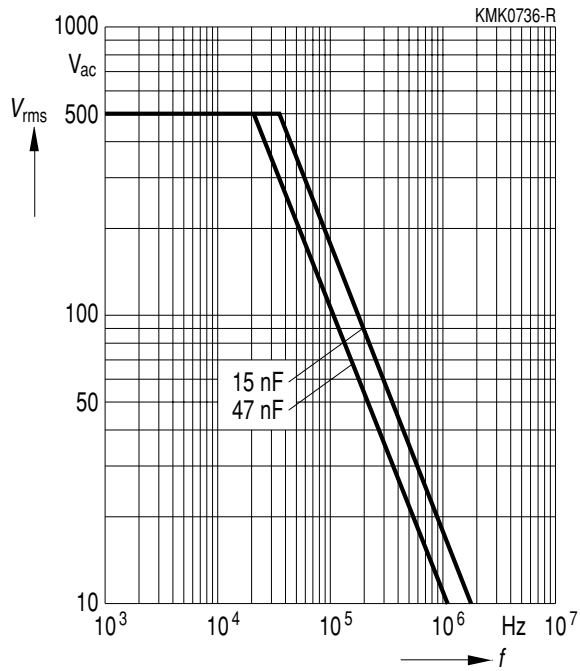

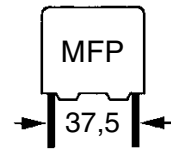

Permissible ac voltage V_{rms} versus frequency f

Lead spacing 37,5 mm

1000 Vdc/ 400 Vac

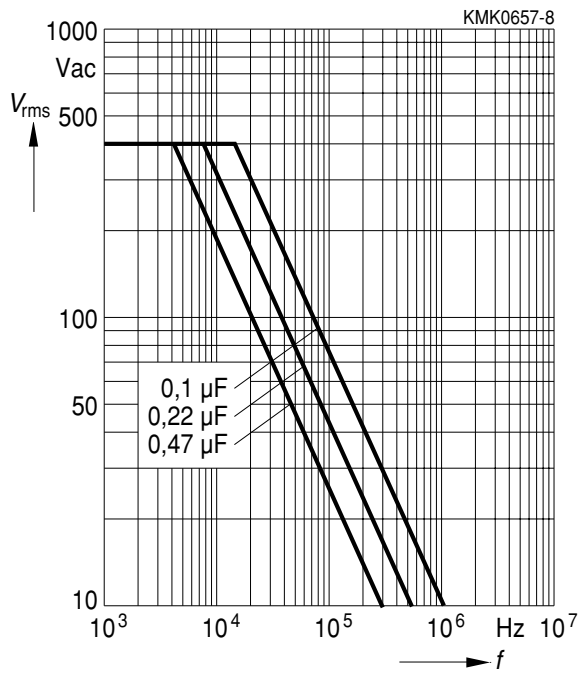

1250 Vdc/ 450 Vac

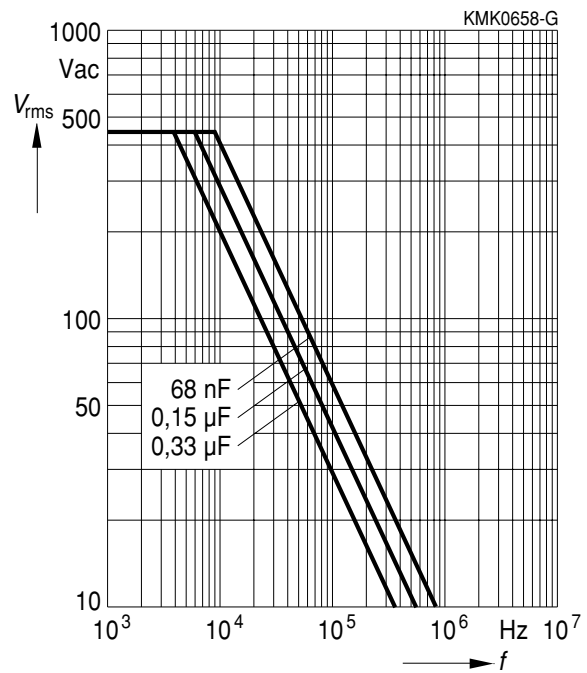

1600 Vdc/ 450 Vac

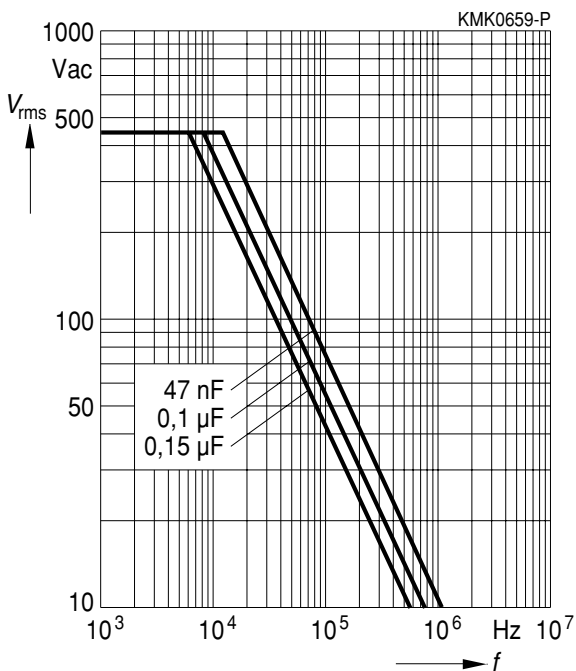

2000 Vdc/ 500 Vac

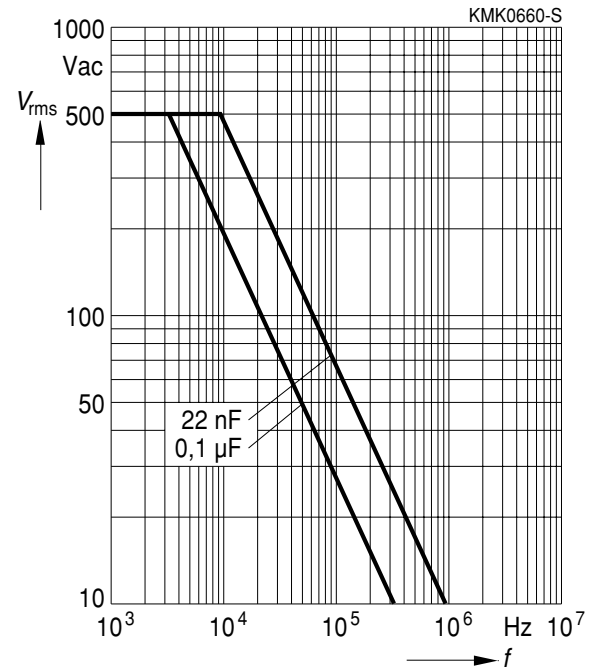

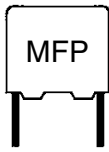

B 32 682 ...

B 32 686

Flyback application

Permissible voltage and current / waveform

Permissible current I_{pp} versus frequency for a duty cycle of 20 % ($t_0/t=0,2$):

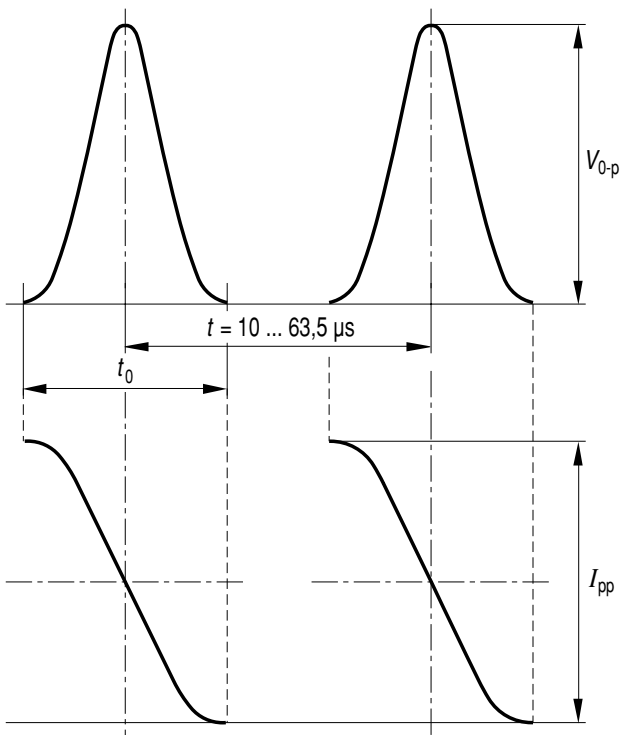

KMK0720-5

Approximation formular for duty cycle higher than 20 %:

$$I'_{pp} = I_{pp} \sqrt{\frac{t_0^3}{t'^3_0}}$$

Flyback application
permissible current I_{pp} versus rated capacitance C_R

Frequency = 15,75 kHz

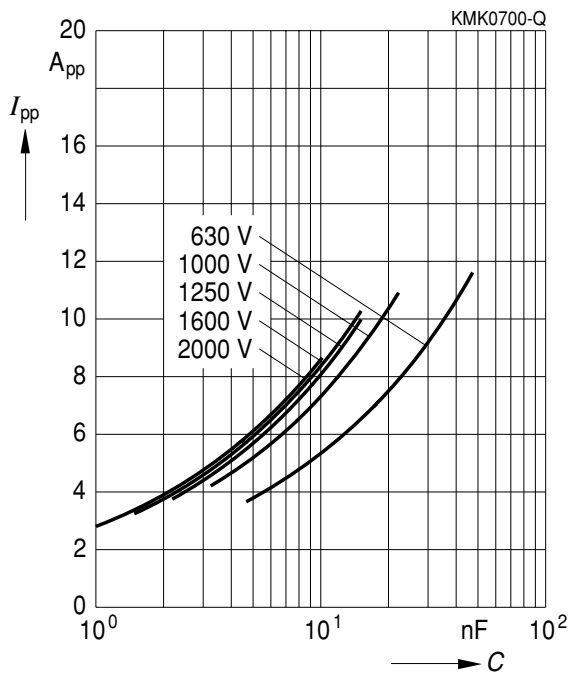

Frequency = 31,5 kHz

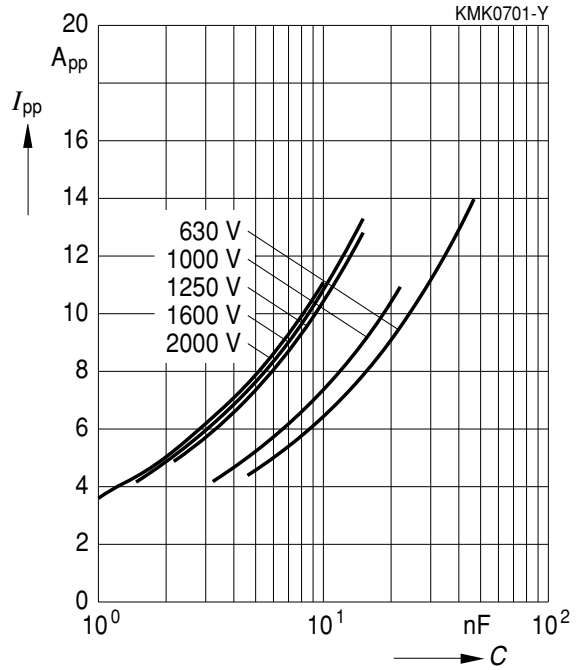

Frequency = 95 kHz

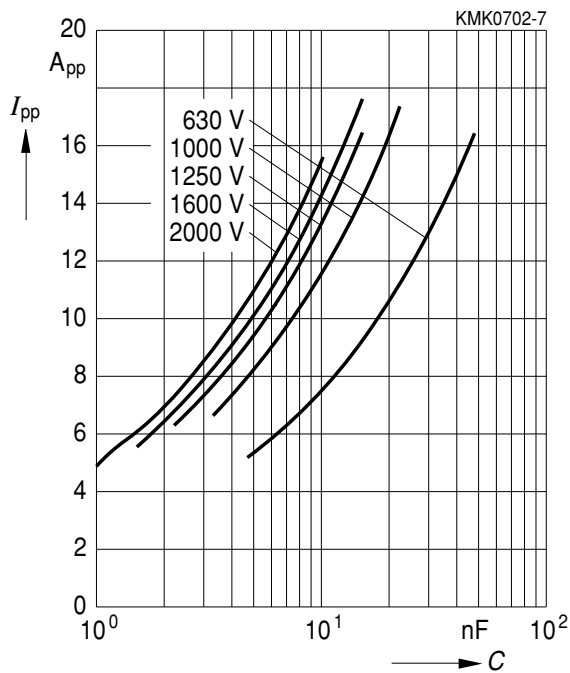

Herausgegeben von EPCOS AG

Marketing Kommunikation, Postfach 80 17 09, 81617 München, DEUTSCHLAND

© EPCOS AG 2000. Alle Rechte vorbehalten. Vervielfältigung, Veröffentlichung, Verbreitung und Verwertung dieser Broschüre und ihres Inhalts ohne ausdrückliche Genehmigung der EPCOS AG nicht gestattet.

Mit den Angaben in dieser Broschüre werden die Bauelemente spezifiziert, keine Eigenschaften zugesichert. Bestellungen unterliegen den vom ZVEI empfohlenen Allgemeinen Lieferbedingungen für Erzeugnisse und Leistungen der Elektroindustrie, soweit nichts anderes vereinbart wird.

Diese Broschüre ersetzt die vorige Ausgabe.

Fragen über Technik, Preise und Liefermöglichkeiten richten Sie bitte an den Ihnen nächstgelegenen Vertrieb der EPCOS AG oder an unsere Vertriebsgesellschaften im Ausland.

Bauelemente können aufgrund technischer Erfordernisse Gefahrstoffe enthalten. Auskünfte darüber bitten wir unter Angabe des betreffenden Typs ebenfalls über die zuständige Vertriebsgesellschaft einzuholen.

Published by EPCOS AG

Marketing Communications, P.O. Box 80 17 09, 81617 Munich, GERMANY

© EPCOS AG 2000. All Rights Reserved. Reproduction, publication and dissemination of this brochure and the information contained therein without EPCOS' prior express consent is prohibited.

The information contained in this brochure describes the type of component and shall not be considered as guaranteed characteristics. Purchase orders are subject to the General Conditions for the Supply of Products and Services of the Electrical and Electronics Industry recommended by the ZVEI (German Electrical and Electronic Manufacturers' Association), unless otherwise agreed.

This brochure replaces the previous edition.

For questions on technology, prices and delivery please contact the Sales Offices of EPCOS AG or the international Representatives.

Due to technical requirements components may contain dangerous substances. For information on the type in question please also contact one of our Sales Offices.