

power light source

Luxeon® Flood

Technical Data DS24

Luxeon® is a revolutionary, energy efficient and ultra compact new light source, combining the lifetime and reliability advantages of Light Emitting Diodes with the brightness of conventional lighting.

Luxeon features one or more power light sources mounted onto an aluminum-core printed circuit board, allowing for ease of assembly, optimum cooling and accurate light center positioning.

For high volume applications, custom Luxeon power light source designs are available upon request, to meet your specific needs.

Luxeon Power Light Sources give you total design freedom and unmatched brightness, creating a new world of light.



Luxeon Flood is available in white, green, cyan, blue, red, and amber.

Features

- Highest Flux per LED in the world
- Very long operating life (up to 100k hours)
- Available in White, Green, Cyan, Blue, Red and Amber
- More Energy Efficient than Incandescent and most Halogen lamps
- Low voltage DC operated
- Cool beam, safe to the touch
- Instant light (less than 100 ns)
- Fully dimmable
- No UV
- Superior ESD protection

Typical Applications

- Decorative flood
- Traffic lights
- Railway crossings and wayside
- Beacons

Mechanical Dimensions

Flood 12-Up

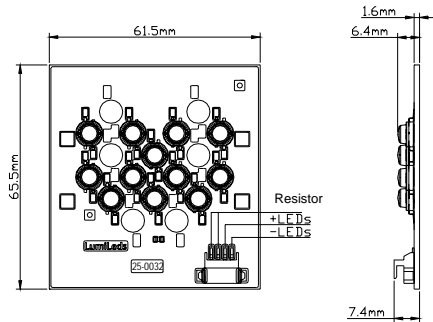

Notes:

1. Connector on board AMP type, code 2-179123-4 ; Mating connector – AMP receptacle housing assembly, code 173977-4.
2. Flood 12-Up has a resistor component, 2.2k Ohm.
3. Drawing not to scale.
4. All dimensions are in millimeters.

Flood 18-Up

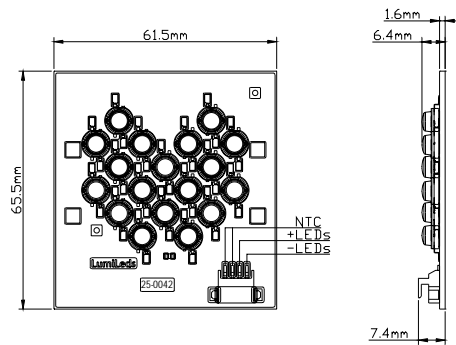

Notes:

1. Connector on board AMP type, code 2-179123-4 ; Mating connector – AMP receptacle housing assembly, code 173977-4.
2. Flood 18-Up has an NTC component, 10k Ohm.
3. Drawing not to scale.
4. All dimensions are in millimeters.

Circuit Diagram

Flood 12-Up

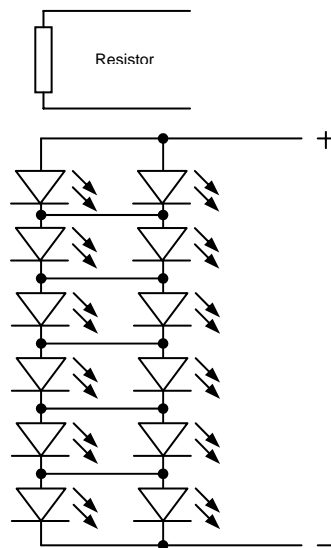

Flood 18-Up

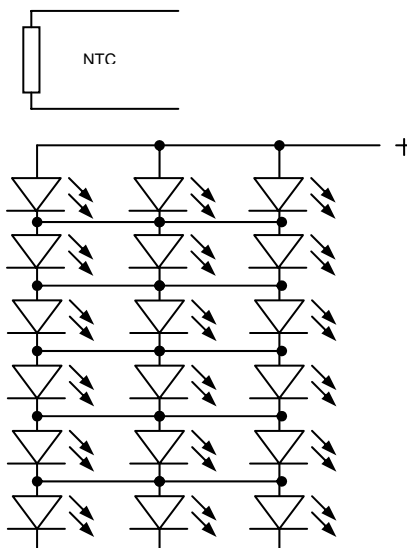

Flux Characteristics at 350mA, Junction Temperature, $T_J = 25^\circ\text{C}$

Configuration	Radiation Pattern	Color	Part Number	Minimum Luminous Flux (lm) $\Phi_V^{[1,2]}$	Typical Luminous Flux (lm) $\Phi_V^{[2]}$	Test Current (mA)
Flood 12-up	Batwing (low dome)	White	LXHL-MWCE	165	300	700
		Green	LXHL-MMCA	165	360	700
		Cyan	LXHL-MECA	165	360	700
		Blue ^[3]	LXHL-MBCA	45	120	700
		Red	LXHL-MDCA	165	320	700
	Amber	LXHL-MLCA	125	300	700	
Lambertian (high dome)	Red	LXHL-MDCB	365	525	700	
	Amber	LXHL-MLCB	280	500	700	
Flood 18-up	Batwing (low dome)	White	LXHL-MWJE	250	450	1050
		Green	LXHL-MMJA	250	540	1050
		Cyan	LXHL-MEJA	250	540	1050
		Blue ^[3]	LXHL-MBJA	65	180	1050
		Red	LXHL-MDJA	250	480	1050
	Amber	LXHL-MLJA	190	450	1050	
Lambertian (high dome)	Red	LXHL-MDJB	550	790	1050	
	Amber	LXHL-MLJB	420	750	1050	

Notes:

1. Minimum luminous flux performance guaranteed within published operating conditions.
2. Luxeon types with even higher luminous flux levels will become available in the future. Please consult your Lumileds Authorized Distributor or Lumileds sales representative for more information.
3. Minimum flux value for 470 nm devices. Due to the CIE eye response curve in the short blue wavelength range, the minimum luminous flux will vary over the Lumileds blue color range. Luminous flux will range from minimums of 35 lm for 12-Up and 50 lm for 18-Up Floods at 460nm to typicals of 190 lm for 12-Up and 280 lm for 18-Up Floods at 480nm due to this effect. Although the luminous power efficiency is lower in the short blue wavelength range, radiometric power efficiency increases as wavelength decreases. For more information, consult the Luxeon Design Guide, available upon request.

Optical Characteristics at 350mA, Junction Temperature, $T_J = 25^\circ\text{C}$

Radiation Pattern	Color	Dominant Wavelength ^[1] λ_D or Color Temperature ^[2] CCT			Spectral Half-width ^[3] (nm) $\Delta\lambda_{1/2}$	temperature coefficient of dominant wavelength (nm/ $^\circ\text{C}$) $\Delta\lambda_D/\Delta T_J$	Viewing Angle per LED ^[4,7] (Degrees) $2\theta_{1/2}$
		Min.	Typ.	Max.			
Batwing (low dome)	White	4500 K	5500 K	10,000 K	---	---	110
	Green	520 nm	530 nm	550 nm	35	0.04	110
	Cyan	490 nm	505 nm	520 nm	30	0.04	110
	Blue	460 nm	470 nm	490 nm	25	0.04	110
	Red	620.5 nm	625 nm	645 nm	20	0.05	110
	Amber	584.5 nm	590 nm	597 nm	14	0.09	110
Lambertian (high dome)	Red	620.5 nm	627 nm	645 nm	20	0.05	140
	Amber	584.5 nm	590 nm	597 nm	14	0.09	140

Notes:

1. Dominant wavelength is derived from the CIE 1931 Chromaticity diagram and represents the perceived color.
2. CRI (Color Rendering Index) for White product types is 70.
3. Spectral width at $1/2$ of the peak intensity.
4. $\theta_{1/2}$ is the off axis angle from lamp centerline where the luminous intensity is $1/2$ of the peak value.
5. Luxeon Floods are not designed for direct view applications. Lumileds reserves the right to mix LEDs of different color and flux values to achieve the typical values listed above, possibly resulting in visible variation across the array.
6. All red and amber products built with Aluminum Indium Gallium Phosphide (AlInGaP).
7. All white, green, cyan, and blue products built with Indium Gallium Nitride (InGaN).
8. All power light sources represented here are IEC825 Class 2 for eye safety.

Electrical Characteristics at Junction Temperature, $T_J = 25^\circ\text{C}$

Flood 12-Up

Radiation Pattern	Color	Forward Voltage (V) V_F			Dynamic resistance ^[1] (Ω) R_D	Temp coefficient of Forward voltage ^[2] ($\text{mV}/^\circ\text{C}$) $\Delta V_F / \Delta T_J$	Thermal resistance, junction to board ^[3] ($^\circ\text{C}/\text{W}$) $R_{\theta_{JB}}$	test current (mA) I_F
		Min.	Typ.	Max.				
Batwing (low dome)	White	16	21	24	3	-12	1.7	700
	Green	16	21	24	3	-12	1.7	700
	Cyan	16	21	24	3	-12	1.7	700
	Blue	16	21	24	3	-12	1.7	700
	Red	14	17	20	7.2	-12	1.7	700
	Amber	14	17	20	7.2	-12	1.7	700
Lambertian (high dome)	Red	14	18	21	7.2	-12	1.9	700
	Amber	14	18	21	7.2	-12	1.9	700

Flood 18-Up

Radiation Pattern	Color	Forward Voltage (V) V_F			Dynamic resistance ^[1] (Ω) R_D	Temp coefficient of forward voltage ^[2] ($\text{mV}/^\circ\text{C}$) $\Delta V_F / \Delta T_J$	Thermal resistance, junction to board ^[3] ($^\circ\text{C}/\text{W}$) $R_{\theta_{JB}}$	test current (mA) I_F
		Min.	Typ.	Max.				
Batwing (low dome)	White	16	21	24	2	-12	1.1	1050
	Green	16	21	24	2	-12	1.1	1050
	Cyan	16	21	24	2	-12	1.1	1050
	Blue	16	21	24	2	-12	1.1	1050
	Red	14	17	20	4.8	-12	1.1	1050
	Amber	14	17	20	4.8	-12	1.1	1050
Lambertian (high dome)	Red	14	18	21	4.8	-12	1.3	1050
	Amber	14	18	21	4.8	-12	1.3	1050

Absolute Maximum Ratings

Parameter	Flood 12-Up		Flood 18-Up	
	White/Green/Cyan/Blue	Red/Amber	White/Green/Cyan/Blue	Red/Amber
DC Forward Current (mA) ^[1]	700	770	1050	1155
Peak Pulsed Forward Current (mA)	1000	1100	1500	1650
Average Forward Current (mA)	700	700	1050	1050
ESD Sensitivity ^[2]	$\pm 16,000\text{V HBM}$		$\pm 16,000\text{V HBM}$	
LED Junction Temperature ($^\circ\text{C}$)	135	120	135	120
Aluminum-Core PCB Temperature ($^\circ\text{C}$)	105	105	105	105
Storage & Operating Temperature ($^\circ\text{C}$)	-40 to +105	-40 to +105	-40 to +105	-40 to +105

Notes:

- Dynamic resistance is the inverse of the slope in linear forward voltage model for LEDs. See *Figures 3a and 3b*.
- Measured between $25^\circ\text{C} \leq T_J \leq 110^\circ\text{C}$ at $I_F = 700\text{mA}$ for Flood 12-Up and $I_F = 1050\text{mA}$ for Flood 18-Up.
- To determine the junction temperature, multiply by total array power. Due to the high packing density of the Floods, the board temperature rise is significant and must always have additional heat sinking at nominal operating conditions.

Notes:

- Proper current derating must be observed to maintain junction temperature below the maximum. For more information, consult Luxeon Design Guide, available upon request.
- LEDs are not designed to be driven in reverse bias. Please consult Lumileds' Application Brief AB11 for further information.

Wavelength Characteristics

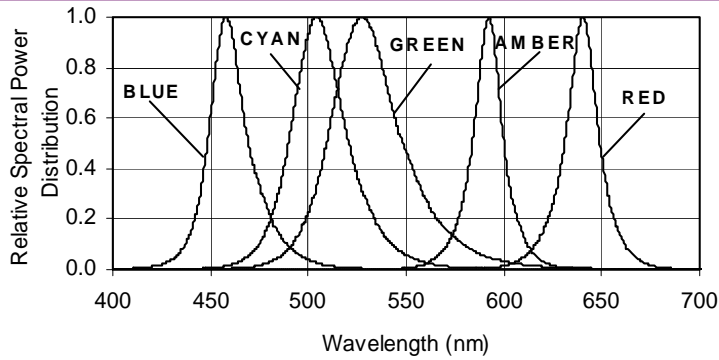

Figure 1a.
Relative Intensity vs. Wavelength.

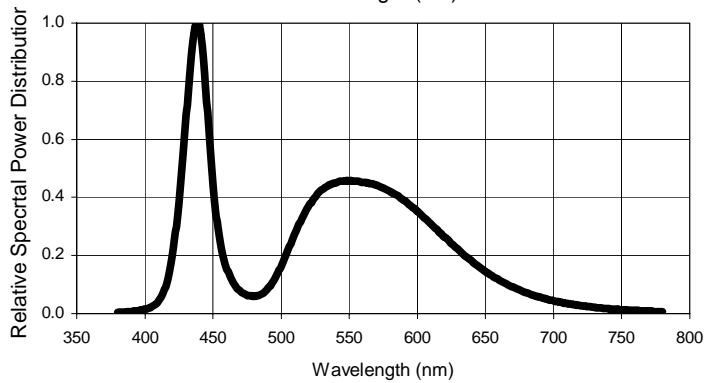

Figure 1b.
White Color Spectrum of Typical CCT Part, Integrated Measurement.

Light Output Characteristics

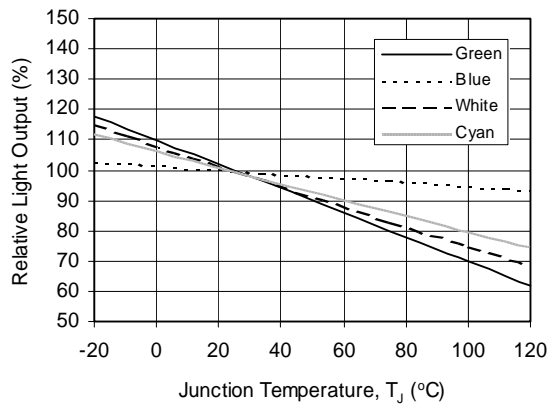

Figure 2a.
Relative Light Output vs. Junction Temperature for White, Green, Cyan and Blue.

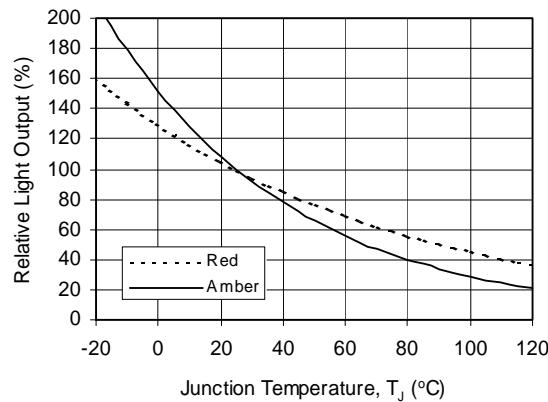

Figure 2b.
Relative Light Output vs. Junction Temperature for Red and Amber.

Forward Current Characteristics, $T_J = 25^\circ\text{C}$

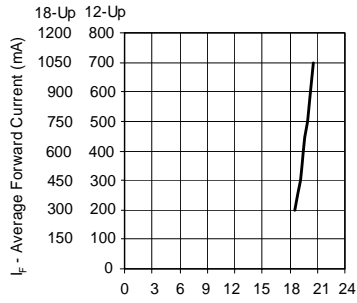

Figure 3a. Forward Current vs. Forward Voltage for White, Green, Cyan and Blue.

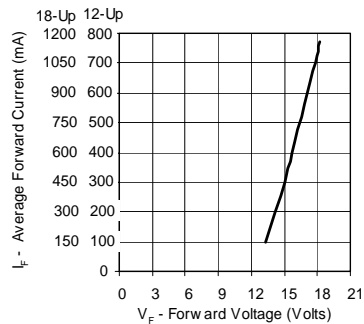

Figure 3b. Forward Current vs. Forward Voltage for Red and Amber.

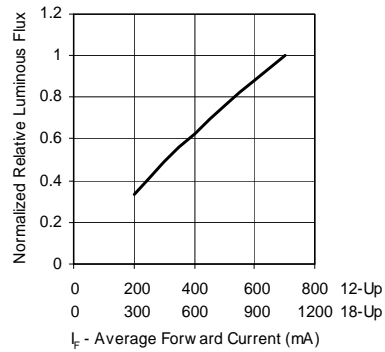

Figure 4a. Relative Luminous Flux vs. Forward Current for White, Green, Cyan and Blue at $T_J = 25^\circ\text{C}$ maintained.

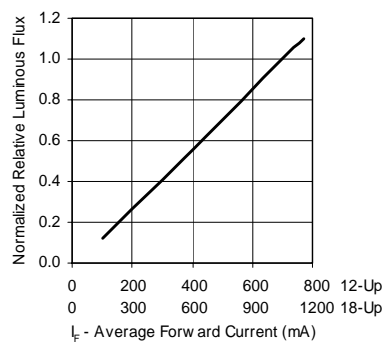

Figure 4b. Relative Luminous Flux vs. Forward Current for Red and Amber at $T_J = 25^\circ\text{C}$ maintained.

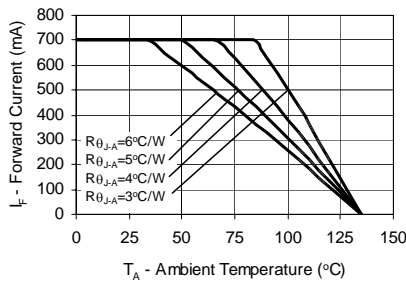

Figure 5a. Maximum Forward Current vs. Ambient Temperature. Derating based on $T_{JMAX} = 135^\circ\text{C}$ for White, Green, Cyan and Blue 12-Up.

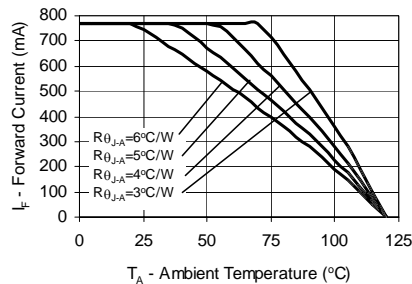

Figure 5b. Maximum Forward Current vs. Ambient Temperature. Derating based on $T_{JMAX} = 120^\circ\text{C}$ for Red and Amber 12-Up.

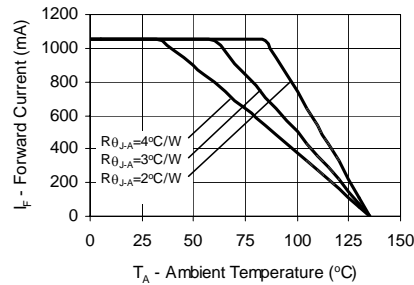

Figure 6a. Maximum Forward Current vs. Ambient Temperature. Derating based on $T_{JMAX} = 135^\circ\text{C}$ for White, Green, Cyan and Blue 18-Up.

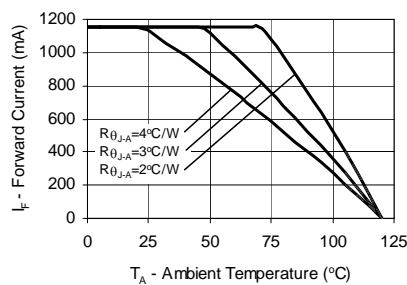

Figure 6b. Maximum Forward Current vs. Ambient Temperature. Derating based on $T_{JMAX} = 120^\circ\text{C}$ for Red and Amber 18-Up.

Note:

Driving these high power devices at currents less than the test conditions may produce unpredictable results and may be subject to variation in performance. Pulse width modulation is recommended for dimming effects.

Representative Spatial Radiation Pattern

Batwing Radiation Pattern (without optics)

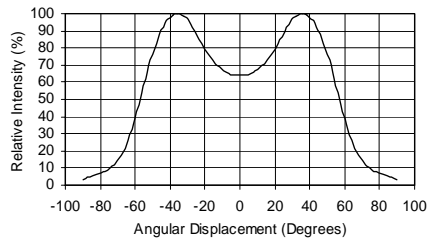

Figure 7a. Representative Spatial Radiation Pattern per Luxeon emitter White.

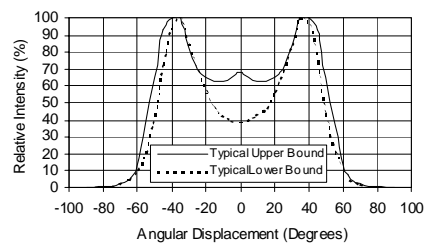

Figure 7b. Representative Spatial Radiation Pattern per Luxeon emitter for Red, Amber, Green, Cyan and Blue.

Note:

For more detailed technical information regarding Luxeon radiation patterns, please consult your Lumileds Authorized Distributor or Lumileds sales representative.

Lambertian Radiation Pattern

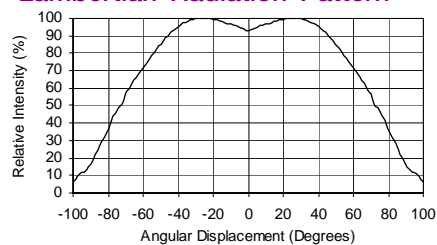

Figure 8. Representative Spatial Radiation Pattern per Luxeon emitter for Red and Amber.

Average Lumen Maintenance Characteristics

Lifetime for solid-state lighting devices (LEDs) is typically defined in terms of lumen maintenance—the percentage of initial light output remaining after a specified period of time. Lumileds projects that Luxeon products will deliver on average 70% lumen maintenance at 50,000 hours of operation. This performance is based on independent test data, Lumileds historical data from tests run on similar material systems, and internal Luxeon reliability testing. This projection is based on constant current 350 mA operation per LED (700 mA 12-Up Flood, 1050 mA for 18-Up Flood) with junction temperature maintained at or below 90°C. Observation of design limits included in this data sheet is required in order to achieve this projected lumen maintenance.

About Luxeon



Luxeon is the new world of solid state lighting (LED) technology. Luxeon Power Light Source Solutions offer huge advantages over conventional lighting and huge advantages over other LED solutions. Luxeon enables partners to create and market products that, until now, were impossible to create. This means the opportunity to create products with a clear competitive advantage in the market. Products that are smaller, lighter, sleeker, cooler, and brighter. Products that are more fun to use, more efficient, and more environmentally conscious than ever before possible!



Company Information

Luxeon is developed, manufactured and marketed by Lumileds Lighting, LLC. Lumileds is a world-class supplier of Light Emitting Diodes (LEDs) producing billions of LEDs annually. Lumileds is a fully integrated supplier, producing core LED material in all three base colors (Red, Green, Blue) and White. Lumileds has R&D development centers in San Jose, California and Best, The Netherlands. Production capabilities in San Jose, California and Malaysia.

Lumileds is pioneering the high-flux LED technology and bridging the gap between solid state LED technology and the lighting world. Lumileds is absolutely dedicated to bringing the best and brightest LED technology to enable new applications and markets in the Lighting world.



©2005 Lumileds Lighting. All rights reserved. Luxeon is a trademark of Lumileds Lighting, U.S., LLC. Product specifications are subject to change without notice.

Lumileds may make process or materials changes affecting the performance or other characteristics of Luxeon. These products supplied after such change will continue to meet published specifications, but may not be identical to products supplied as samples or under prior orders.

Lumileds

www.luxeon.com
www.lumileds.com

For technical assistance or the location of your nearest Lumileds sales office, call:

Worldwide:
+1 408-435-6111
US Toll free: 1-888-589-3662
Asia: 800-5864-5337
Europe: 00 800 443 88 873
Fax: +1 408-435-6855
Email us at info@lumileds.com

Lumileds Lighting, U.S., LLC
370 West Trimble Road
San Jose, CA 95131