

GaAs MMIC SPDT NON-REFLECTIVE SWITCH, DC - 15 GHz

Typical Applications

Broadband switch for DC - 15 GHz applications:

- Fiber Optics
- Microwave Radio
- Military & Space
- Test Equipment
- VSAT

Features

- High Isolation: >50 dB @ 10 GHz
- Low Insertion Loss: 1.4 dB @ 6 GHz
- Non-Reflective Design
- Die Size: 2.05 x 1.04 x 0.1 mm
- Direct Replacement for HMC132

Functional Diagram

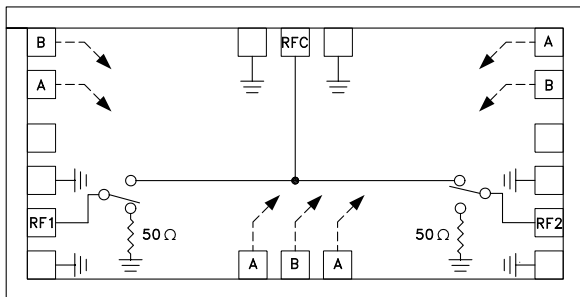

General Description

The HMC232 is a broadband non-reflective GaAs MESFET SPDT MMIC chip. Covering DC to 15 GHz, the switch features over 55 dB isolation at lower frequencies and over 45 dB at higher frequencies due to the implementation of on-chip via hole structures. The switch operates using two negative control voltage logic lines (A&B) of -5/0V and requires no Vee. Alternate A & B control pads are provided to ease MIC implementation. All data shown is tested with the chip in a 50 Ohm test fixture connected via 0.025 mm (1 mil) diameter wire bonds of 0.5 mm (20 mils) length. This product is a form, fit & functional replacement for the HMC132.

Electrical Specifications, $T_A = +25^\circ C$, With 0/-5V Control, 50 Ohm System

Parameter	Frequency	Min.	Typ.	Max.	Units
Insertion Loss	DC - 6 GHz		1.4	1.7	dB
	DC - 10 GHz		2.2	2.5	dB
	DC - 15 GHz		3.1	3.4	dB
Isolation	DC - 6 GHz	50	55		dB
	DC - 10 GHz	45	50		dB
	DC - 15 GHz	40	45		dB
Return Loss	DC - 6 GHz		18		dB
	DC - 15 GHz		12		dB
Return Loss RF1, RF2	DC - 6 GHz		14		dB
	DC - 15 GHz		13		dB
Input Power for 1 dB Compression	0.5 - 15 GHz	21	26		dBm
Input Third Order Intercept (Two-Tone Input Power= +7 dBm Each Tone, 1 MHz Tone Separation)	0.5 - 15 GHz	44	49		dBm
Switching Characteristics tRISE, tFALL (10/90% RF) tON, tOFF (50% CTL to 10/90% RF)	DC - 15 GHz		3		ns
			5		ns

For price, delivery, and to place orders, please contact Hittite Microwave Corporation:
 20 Alpha Road, Chelmsford, MA 01824 Phone: 978-250-3343 Fax: 978-250-3373
 Order On-line at www.hittite.com

GaAs MMIC SPDT NON-REFLECTIVE SWITCH, DC - 15 GHz

Insertion Loss vs. Temperature

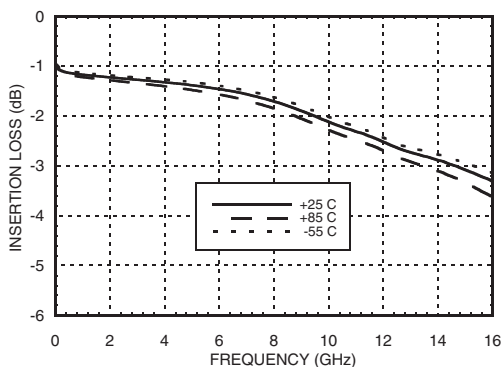

Isolation

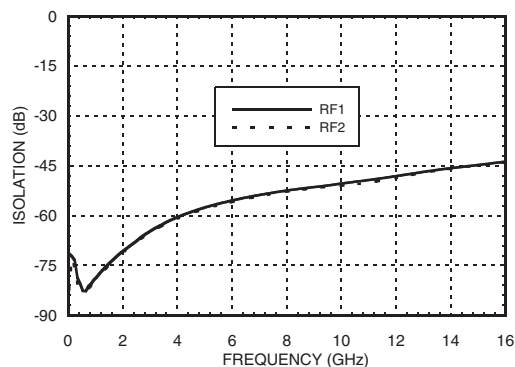

Return Loss

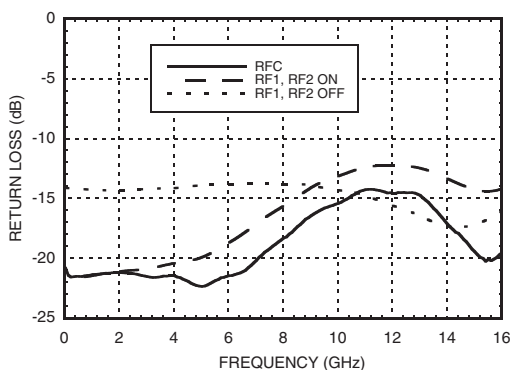

0.1 and 1 dB Input Compression Point

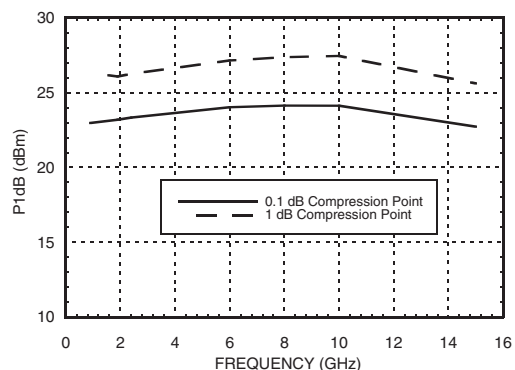

Input Third Order Intercept Point

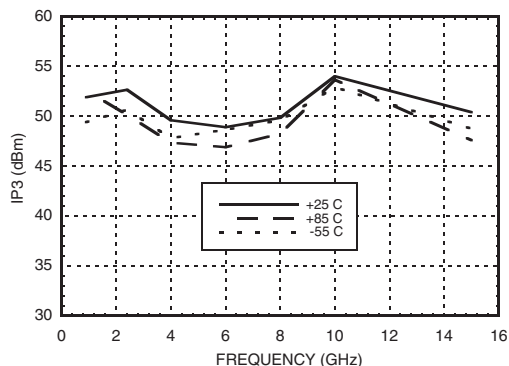

For price, delivery, and to place orders, please contact Hittite Microwave Corporation:
20 Alpha Road, Chelmsford, MA 01824 Phone: 978-250-3343 Fax: 978-250-3373
Order On-line at www.hittite.com

GaAs MMIC SPDT NON-REFLECTIVE SWITCH, DC - 15 GHz

Absolute Maximum Ratings

RF Input Power (Vctl = -5V) (0.5 - 15 GHz)	+30 dBm (@ +50 °C)
Control Voltage Range (A & B)	+1 V to -7.5 Vdc
Channel Temperature	150 °C
Thermal Resistance	92 °C/W
Storage Temperature	-65 to +150 °C
Operating Temperature	-55 to +85 °C
ESD Sensitivity (HBM)	Class 1A

Control Voltages

State	Bias Condition
Low	0 to -0.2V @ 10 uA Max.
High	-5V @ 10 uA Typ. to -7V @ 45 uA Typ.

Truth Table

Control Input		Signal Path State	
A	B	RFC to RF1	RFC to RF2
High	Low	ON	OFF
Low	High	OFF	ON

Caution: Do not "Hot Switch" power levels greater than +26 dBm (Vctl = 0/-5 Vdc).



Outline Drawing

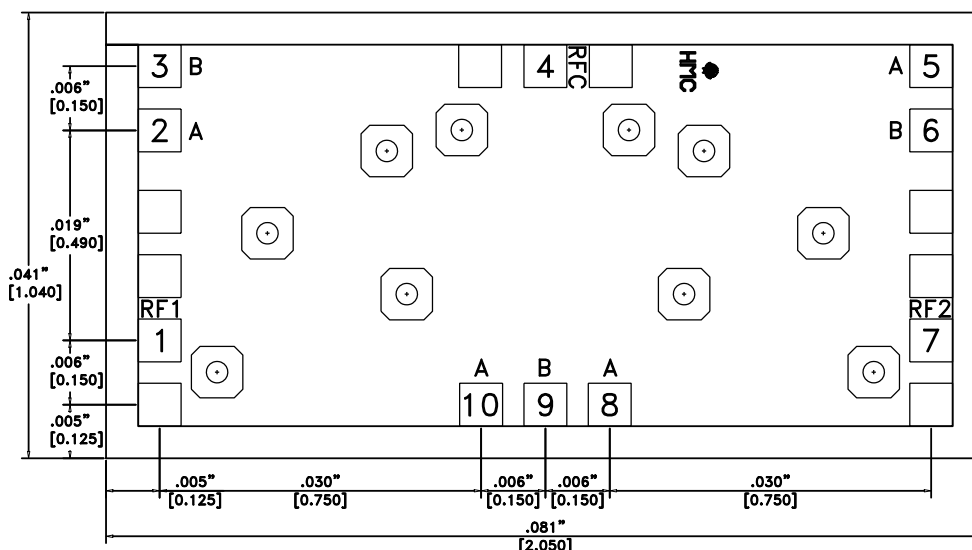

Die Packaging Information [1]

Standard	Alternate
WP-17	[2]

[1] Refer to the "Packaging Information" section for die packaging dimensions.

[2] For alternate packaging information contact Hittite Microwave Corporation.

NOTES:

- ALL DIMENSIONS IN INCHES [MILLIMETERS]
- BOND PADS ARE 0.004" SQUARE
- TYPICAL BOND PAD SPACING CENTER TO CENTER IS .006"
- BACKSIDE METALIZATION: GOLD
- BOND PAD METALIZATION: GOLD
- BACKSIDE OF DIE IS GROUND
- DIE THICKNESS IS .004"
- NO CONNECTION REQUIRED FOR UNLABELED BOND PADS

For price, delivery, and to place orders, please contact Hittite Microwave Corporation:
20 Alpha Road, Chelmsford, MA 01824 Phone: 978-250-3343 Fax: 978-250-3373
Order On-line at www.hittite.com

GaAs MMIC SPDT NON-REFLECTIVE SWITCH, DC - 15 GHz

Suggested Driver Circuit

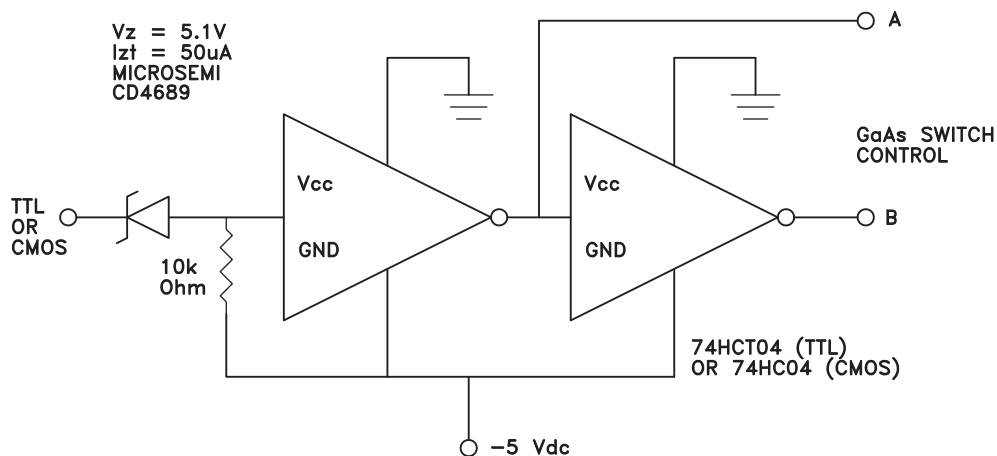

Pad Descriptions

Pad Number	Function	Description	Interface Schematic
2, 5, 8, 10	A	See truth table and control voltage table. Alternate A & B control pads provided.	
3, 6, 9	B	See truth table and control voltage table. Alternate A & B control pads provided.	
1, 4, 7	RF1, RFC, RF2	This pad is DC coupled and matched to 50 Ohms. Blocking capacitors are required if the RF line potential is not equal to 0V.	
	GND	Die bottom must be connected to RF ground.	

For price, delivery, and to place orders, please contact Hittite Microwave Corporation:
20 Alpha Road, Chelmsford, MA 01824 Phone: 978-250-3343 Fax: 978-250-3373
Order On-line at www.hittite.com

GaAs MMIC SPDT NON-REFLECTIVE SWITCH, DC - 15 GHz

Assembly Diagram

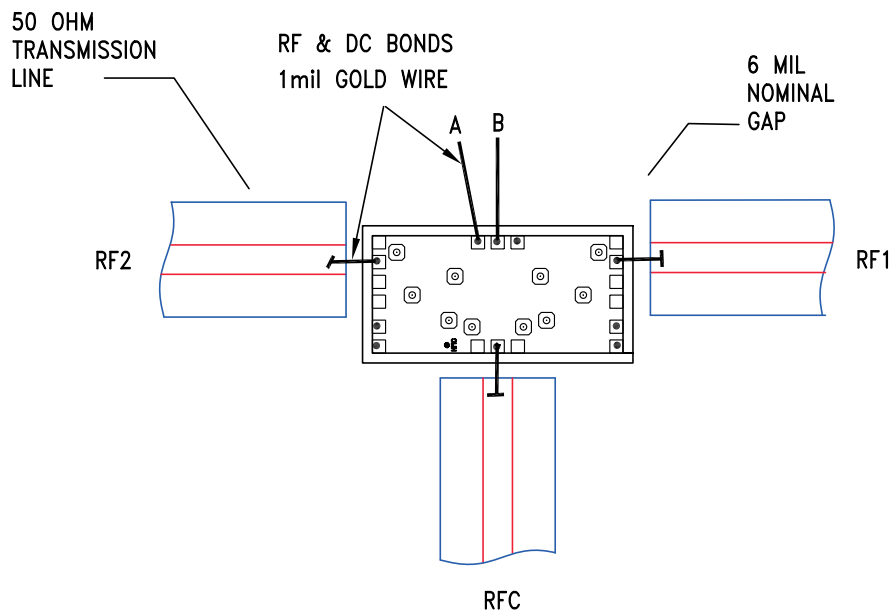

For price, delivery, and to place orders, please contact Hittite Microwave Corporation:
20 Alpha Road, Chelmsford, MA 01824 Phone: 978-250-3343 Fax: 978-250-3373
Order On-line at www.hittite.com

GaAs MMIC SPDT NON-REFLECTIVE SWITCH, DC - 15 GHz

Mounting & Bonding Techniques for Millimeterwave GaAs MMICs

The die should be attached directly to the ground plane eutectically or with conductive epoxy (see HMC general Handling, Mounting, Bonding Note).

50 Ohm Microstrip transmission lines on 0.127mm (5 mil) thick alumina thin film substrates are recommended for bringing RF to and from the chip (Figure 1). If 0.254mm (10 mil) thick alumina thin film substrates must be used, the die should be raised 0.150mm (6 mils) so that the surface of the die is coplanar with the surface of the substrate. One way to accomplish this is to attach the 0.102mm (4 mil) thick die to a 0.150mm (6 mil) thick molybdenum heat spreader (moly-tab) which is then attached to the ground plane (Figure 2).

Microstrip substrates should be brought as close to the die as possible in order to minimize bond wire length. Typical die-to-substrate spacing is 0.076mm (3 mils).

Handling Precautions

Follow these precautions to avoid permanent damage.

Storage: All bare die are placed in either Waffle or Gel based ESD protective containers, and then sealed in an ESD protective bag for shipment. Once the sealed ESD protective bag has been opened, all die should be stored in a dry nitrogen environment.

Cleanliness: Handle the chips in a clean environment. DO NOT attempt to clean the chip using liquid cleaning systems.

Static Sensitivity: Follow ESD precautions to protect against ESD strikes.

Transients: Suppress instrument and bias supply transients while bias is applied. Use shielded signal and bias cables to minimize inductive pick-up.

General Handling: Handle the chip along the edges with a vacuum collet or with a sharp pair of bent tweezers. The surface of the chip has fragile air bridges and should not be touched with vacuum collet, tweezers, or fingers.

Mounting

The chip is back-metallized and can be die mounted with AuSn eutectic preforms or with electrically conductive epoxy. The mounting surface should be clean and flat.

Epoxy Die Attach: Apply a minimum amount of epoxy to the mounting surface so that a thin epoxy fillet is observed around the perimeter of the chip once it is placed into position. Cure epoxy per the manufacturer's schedule.

Wire Bonding

Ball or wedge bond with 0.025 mm (1 mil) diameter pure gold wire (DC bias, IF1 and IF2) or Ribbon Bond (RF and LO ports) 0.076 mm x 0.013 mm (3 mil x 0.5 mil) size is recommended. Thermosonic wirebonding with a nominal stage temperature of 150 °C and a ball bonding force of 40 to 50 grams or wedge bonding force of 18 to 22 grams is recommended. Use the minimum level of ultrasonic energy to achieve reliable wirebonds. Wirebonds should be started on the chip and terminated on the package or substrate. All bonds should be as short as possible <0.31 mm (12 mils).

