



## Reset Circuit with Manual Reset and Watchdog

### Description

The EM6323/24 are low power, high precision reset ICs featuring a manual reset and a watchdog inputs. They have different threshold voltages and several timeout reset periods ( $t_{POR}$ ) and watchdog timeout periods ( $t_{WD}$ ) for maximum flexibility in the application. EM6323 has a manual reset ( $\overline{MR}$  with internal pull-up) and a watchdog input pins. EM6324 has only a watchdog input pin (WDI). The watchdog function can be disabled by driving WDI with a three-state driver or by leaving WDI unconnected. This is useful when the MCU is in sleep mode.

Small SOT23-5L package as well as ultra-low supply current of 3.8 $\mu$ A make the EM6323 and the EM6324 an ideal choice for portable and battery-operated devices.

### Typical Application

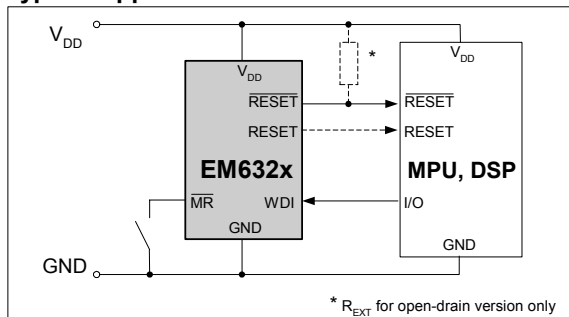

Fig. 1

### Block Diagram

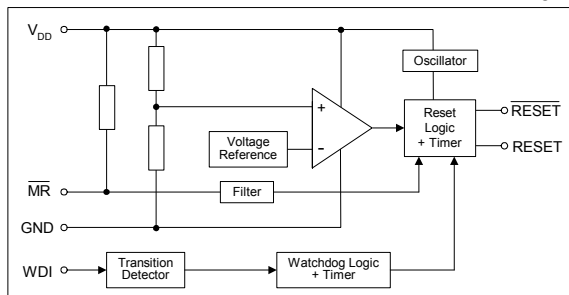

Fig. 2

### Features

- ❑ Ultra-low supply current of 3.8 $\mu$ A ( $V_{DD}=3.3V$ )
- ❑ Operating temperature range: -40°C to +125°C
- ❑  $\pm 1.5\%$  reset threshold accuracy
- ❑ 11 reset threshold voltages  $V_{TH}$ : 4.63V, 4.4V, 3.08V, 2.93V, 2.8V, 2.63V, 2.3V, 2.2V, 2.0V, 1.8V, 1.66V, 1.57V, 1.38V, 1.31V
- ❑ 200ms reset timeout period (1.6ms, 25ms, 1600ms on request)
- ❑ 1.6s watchdog timeout period (6.2ms, 102ms, 25.6s on request)
- ❑ 3 reset output options:
  - Active-low  $\overline{RESET}$  push-pull
  - Active-low  $\overline{RESET}$  open-drain
  - Active-high RESET push-pull
- ❑ Detection of microcontroller in sleep mode

### Applications

- ❑ Workstations
- ❑ Point of sales (POS)
- ❑ Personal computers
- ❑ Routers, hubs and switches
- ❑ Handheld GPS
- ❑ Vending machines and ATM
- ❑ Automotive systems

### Pin Configuration

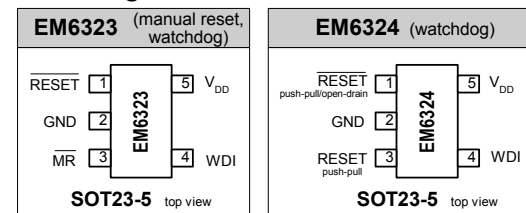

Fig. 3

### Pin Description

SOT23-5L		Name	Function
EM6323	EM6324		
1	1	RESET	Active-low $\overline{RESET}$ output (push-pull or open-drain)
2	2	GND	Ground
3	-	$\overline{MR}$	Manual Reset input with an internal pull-up 30k $\Omega$ resistor. Reset remains active as long as $\overline{MR}$ is low and for $t_{POR}$ after returns high. $\overline{MR}$ can be driven with a CMOS output or shorted to ground with a switch
-	3	RESET	Active-high RESET output (push-pull)
4	4	WDI	Watchdog input. WDI must be driven with a CMOS output. If the microcontroller I/O is put in a high impedance condition, the circuit will detect this condition as a microcontroller in sleep mode and prevent its watchdog from timing out
5	5	$V_{DD}$	Supply Voltage (5.5V max.)



# EM6323/24

## Ordering Information

**EM6323 L X SP5B - 2.9 +**

**Part Number:**  
**EM6323** = manual reset & watchdog  
**EM6324** = watchdog

**Delays  $t_{POR}$  &  $t_{WD}$  :**

		$t_{POR}$ [ms]				
		1.6	25	200	1600	
$t_{WD}$ [ms]	6.2	A	B	C	D	
	102	E	F	G	H	
	1600	J	K	L	M	
	25600	N	P	Q	R	

("L" is the standard version")

**RoHS Compliance:**  
 + = lead-free/green mold compliant  
 [blank] = leaded

**Reset Threshold Voltage:**  
 1.3 = 1.31V   1.8 = 1.80V   2.6 = 2.63V   4.4 = 4.40V  
 1.4 = 1.38V   2.0 = 2.00V   2.8 = 2.80V   4.6 = 4.63V  
 1.6 = 1.57V   2.2 = 2.20V   2.9 = 2.93V  
 1.7 = 1.66V   2.3 = 2.30V   3.1 = 3.08V

**Package:**  
**SP5B** = 5-pin SOT23-5, tape&reel, 3000 pcs

**Reset Output Type:**  
**X** = Active-low /RESET push-pull (Active-high RESET push-pull also for EM6324)  
**Y** = Active-low /RESET open-drain (Active-high RESET push-pull also for EM6324)  
**Z** = Active-high RESET push-pull (EM6323 only)

**Note:** subject to availability (see standard versions list below). Please give complete Part Number when ordering

## Standard Versions (Top Marking)

Threshold Voltage	Delay ( $t_{POR}$ )/ Watchdog timer ( $t_{WD}$ )	Output Type	Package	Part Number	Top Marking <sup>1)</sup>	Top Marking with 4 characters <sup>2)</sup>
2.6V	200ms/1600ms	Active-high push-pull RESET	SOT23-5L	EM6323LZSP5B-2.6		APL5
2.63V	200ms/1600ms	Active-low push-pull $\overline{\text{RESET}}$	SOT23-5L	EM6323LXSP5B-2.6		APLG
2.63V	200ms/1600ms	Active-low push-pull $\overline{\text{RESET}}$	SOT23-5L	EM6323LXSP5B-2.6+	KF##	BPLG
2.93V	200ms/1600ms	Active-low push-pull $\overline{\text{RESET}}$	SOT23-5L	EM6323LXSP5B-2.9		APLH
2.93V	200ms/1600ms	Active-low push-pull $\overline{\text{RESET}}$	SOT23-5L	EM6323LXSP5B-2.9+	K0##	BPLH
3.08V	200ms/1600ms	Active-low push-pull $\overline{\text{RESET}}$	SOT23-5L	EM6323LXSP5B-3.1		APLJ
2.93V	200ms/1600ms	Active-low open-drain $\overline{\text{RESET}}$	SOT23-5L	EM6323LYSP5B-2.9		APLU
2.93V	200ms/1600ms	Active-low open-drain $\overline{\text{RESET}}$	SOT23-5L	EM6323LYSP5B-2.9+	K6##	BPLU
3.1V	200ms/1600ms	Active-low open-drain $\overline{\text{RESET}}$	SOT23-5L	EM6323LYSP5B-3.1		APLV
3.1V	200ms/1600ms	Active-low push-pull $\overline{\text{RESET}}$	SOT23-5L	EM6323LXSP5B-3.1		APLJ
4.40V	200ms/1600ms	Active-low push-pull $\overline{\text{RESET}}$	SOT23-5L	EM6324LXSP5B-4.4		AQMK
4.40V	200ms/1600ms	Active-low push-pull $\overline{\text{RESET}}$	SOT23-5L	EM6324LXSP5B-4.4+	K9##	BQMK
2.9V	200ms/1600ms	Active-low open-drain $\overline{\text{RESET}}$	SOT23-5L	EM6324LYSP5B-2.9		AQLU
1.38V	200ms/25600ms	Active-low push-pull $\overline{\text{RESET}}$	SOT23-5L	EM6324QXSP5B-1.4		AQQB
2.0V	200ms/25600ms	Active-low open-drain $\overline{\text{RESET}}$	SOT23-5L	EM6324QYSP5B-2.0+	KH##	
2.3V	200ms/25600ms	Active-low open-drain $\overline{\text{RESET}}$	SOT23-5L	EM6324QYSP5B-2.3+	KJ##	
2.8V	200ms/25600ms	Active-low open-drain $\overline{\text{RESET}}$	SOT23-5L	EM6324QYSP5B-2.8+	KK##	

<sup>1)</sup> Top marking is standard from 2006. No bottom marking exists. Where ## refers to the lot number (EM internal reference only)

<sup>2)</sup> Top marking with 4 characters is standard from 2003. For lead-free/green mold (RoHS) parts, the first letter of top marking with 4 characters begins with letter "B" instead of letter "A". Bottom marking indicates the lot number.



## Standard Versions (samples)

Part Number
EM6323LXSP5B-2.6+
EM6323LXSP5B-2.9+

Part Number
EM6323LYSP5B-2.9+
EM6324LXSP5B-4.4+

Sample stock is generally held on **standard versions** only. Please contact factory for other versions not shown here and for availability of non standard versions.

## Absolute Maximum Ratings

Parameter	Symbol	Conditions
Voltage at $V_{DD}$ to GND	$V_{DD}$	-0.3V to +6V
Minimum voltage at any signal pin	$V_{MIN}$	GND - 0.3V
Maximum voltage at any signal pin	$V_{MAX}$	$V_{DD} + 0.3V$
Electrostatic discharge max. to MIL-STD-883C method 3015.7 with ref. to $V_{SS}$	$V_{ESD}$	2000V
Max. soldering conditions	$T_{MAX}$	250°C x 10s
Storage Temperature Range	$T_{STG}$	-65°C to +150°C

Stresses above these listed maximum ratings may cause permanent damages to the device. Exposure beyond specified operating conditions may affect device reliability or cause malfunction.

## Handling Procedures

This device has built-in protection against high static voltages or electric fields; however, anti-static precautions must be taken as for any other CMOS component. Unless otherwise specified, proper operation can only occur when all terminal voltages are kept within the voltage range. Unused inputs must always be tied to a defined logic voltage level.

## Operating Conditions

Parameter	Symbol	Min	Max	Unit
Supply voltage	$V_{DD}$	0.9	5.5	V
Operating Temperature	$T_A$	-40	+125	°C
Input transition rise and fall rate on $\overline{MR}$ and WDI	$t_R/t_F$	-	100	ns/V

## Electrical Characteristics

Unless otherwise specified:  $V_{DD}=0.9V$  to  $5.5V$ ,  $T_A=-40^\circ C$  to  $+125^\circ C$  (note 1).

Parameter	Symbol	Conditions	Min	Typ	Max	Unit	
Supply current (note 2)	$I_{DD}$	$V_{DD}=1.5V$	+25°C	-	2.4	4.4	$\mu A$
			-40°C to +125°C	-	-	6.8	
		$V_{DD}=3.3V$	+25°C	-	3.86	6.1	
			-40°C to +125°C	-	-	9.9	
		$V_{DD}=5.0V$	+25°C	-	5.89	8.6	
			-40°C to +125°C	-	-	11.6	
Threshold voltage (note 3)	$V_{TH}$	EM6323/24 – 1.3	+25°C	1.290	1.31	1.330	V
			-40°C to +85°C	1.245	-	1.382	
			-40°C to +125°C	1.221	-	1.387	
		EM6323/24 – 1.4	+25°C	1.359	1.38	1.401	
			-40°C to +85°C	1.311	-	1.456	
			-40°C to +125°C	1.286	-	1.461	
		EM6323/24 – 1.6	+25°C	1.546	1.57	1.594	
			-40°C to +85°C	1.492	-	1.656	
			-40°C to +125°C	1.463	-	1.663	
		EM6323/24 – 1.7	+25°C	1.635	1.66	1.685	
			-40°C to +85°C	1.577	-	1.751	
			-40°C to +125°C	1.547	-	1.758	
		EM6323/24 – 1.8	+25°C	1.773	1.80	1.827	
			-40°C to +85°C	1.710	-	1.899	
			-40°C to +125°C	1.678	-	1.906	
		EM6323/24 – 2.0	+25°C	1.970	2.00	2.030	
			-40°C to +85°C	1.900	-	2.110	
			-40°C to +125°C	1.864	-	2.118	
		EM6323/24 – 2.2	+25°C	2.167	2.20	2.233	
			-40°C to +85°C	2.090	-	2.321	
			-40°C to +125°C	2.050	-	2.330	
		EM6323/24 – 2.3	+25°C	2.266	2.30	2.335	
			-40°C to +85°C	2.185	-	2.427	
			-40°C to +125°C	2.144	-	2.436	
EM6323/24 – 2.6	+25°C	2.591	2.63	2.669			
	-40°C to +85°C	2.499	-	2.775			
	-40°C to +125°C	2.451	-	2.785			
EM6323/24 – 2.8	+25°C	2.758	2.8	2.842			
	-40°C to +85°C	2.660	-	2.954			



# EM6323/24

		EM6323/24 – 2.9	-40°C to +125°C	2.610	2.93	2.965		
			+25°C	2.886		2.974		
			-40°C to +85°C	2.784		3.091		
		EM6323/24 – 3.1			-40°C to +125°C	2.731	3.08	3.103
					+25°C	3.034		3.126
					-40°C to +85°C	2.926		3.249
		EM6323/24 – 4.4			-40°C to +125°C	2.871	4.40	3.262
					+25°C	4.334		4.466
					-40°C to +85°C	4.180		4.642
		EM6323/24 – 4.6			-40°C to +125°C	4.101	4.63	4.660
					+25°C	4.561		4.699
					-40°C to +85°C	4.399		4.885
			-40°C to +125°C	4.315		4.903		

**Note 1:** Production tested at +25°C only. Over temperature limits are guaranteed by design, not production tested.

**Note 3:** Threshold voltage is specified for  $V_{DD}$  falling.



## Electrical Characteristics (continued)

Unless otherwise specified:  $V_{DD}=0.9V$  to  $5.5V$ ,  $T_A=-40^{\circ}C$  to  $+125^{\circ}C$  (note 1).

Parameter	Symbol	Conditions	Min	Typ	Max	Unit	
Threshold hysteresis	$V_{HYS}$	$T_A=+25^{\circ}C$	-	$2.1\% \cdot V_{TH}$	-	V	
Reset timeout period	$t_{POR}$	$V_{DD}$ from 0V to $V_{TH(typ)}+15\%$ $T_A=+25^{\circ}C$ (note 2 and 4)	EM6323/24 C-G-L-Q	160	200	240	ms
			EM6323/24 A-E-J-N	0.7	1.56	3.8	
			EM6323/24 B-F-K-P	20	25	30	
			EM6323/24 D-H-M-R	1280	1600	1920	
Propagation delay time $V_{DD}$ to $\overline{RESET}$ (RESET) delay	$t_P$	$V_{DD}$ drops from $V_{TH(typ)}+0.2V$ to $V_{TH(typ)}-0.2V$ (note 2). $T_A=+25^{\circ}C$	2	70	255	$\mu s$	
Open-drain $\overline{RESET}$ output Voltage	$V_{OL}$	$V_{DD}>1V$	$I_{OL}=100\mu A$	-	-	0.3	V
		$V_{DD}>2.5V$	$I_{OL}=1.5mA$	-	-	0.3	
		$V_{DD}>5V$	$I_{OL}=3mA$	-	-	0.35	
Push-pull $\overline{RESET}$ / $\overline{RESET}$ Output voltage	$V_{OL}$	$V_{DD}>1V$	$I_{OL}=100\mu A$	-	-	0.3	V
		$V_{DD}>2.5V$	$I_{OL}=1.5mA$	-	-	0.3	
		$V_{DD}>5V$	$I_{OL}=3mA$	-	-	0.35	
	$V_{OH}$	$V_{DD}>1.1V$	$I_{OH}=-30\mu A$	0.8	-	-	
		$V_{DD}>2.5V$	$I_{OH}=-1.5mA$	2	-	-	
		$V_{DD}>5V$	$I_{OH}=-3mA$	4	-	-	
Output leakage current	$I_{LEAK}$	Only for EM6323/24_Y (open-drain)	-	-	0.5	$\mu A$	
<b>WATCHDOG INPUT (WDI)</b>							
WDI Input low	$V_{WDI, low}$	$T_A=+25^{\circ}C$	-	-	$0.3 \cdot V_{DD}$	V	
WDI Input high	$V_{WDI, high}$		$0.7 \cdot V_{DD}$	-	-	V	
Pulse width at WDI	$t_{WP}$		1	-	-	$\mu s$	
Watchdog timeout period	$t_{WD}$	(note 6)	EM6323/24 J-K-L-M	1280	1600	1920	ms
			EM6323/24 A-B-C-D	5	6.25	7.5	
			EM6323/24 E-F-G-H	80	100	120	
			EM6323/24 N-P-Q-R	20480	25600	30720	
High-level Input Current	$I_{IH}$	WDI connected to $V_{DD}$ , $T_A=+25^{\circ}C$	-	18	-	$\mu A$	
Low-level Input Current	$I_{IL}$	WDI connected to GND, $T_A=+25^{\circ}C$	-	8.3	-	$\mu A$	
<b>MANUAL RESET (MR) – EM6323 only</b>							
$\overline{MR}$ Input low	$V_{MRT, low}$	$T_A=+25^{\circ}C$	-	-	$0.3 \cdot V_{DD}$	V	
$\overline{MR}$ Input high	$V_{MRT, high}$		$0.7 \cdot V_{DD}$	-	-	V	
$\overline{MR}$ to Reset delay	$t_{MD}$		-	0.3	-	$\mu s$	
Pulse width at $\overline{MR}$ (note 5)	$t_{PMD}$		1	-	-	$\mu s$	
$\overline{MR}$ Internal Pull-up resistor	$R_{MR}$	$T_A=-40^{\circ}C$ to $+125^{\circ}C$	7	30	74	$k\Omega$	

**Note 1:** Production tested at  $+25^{\circ}C$  only. Over temperature limits are guaranteed by design, not production tested.

**Note 2:** WDI, MR and  $\overline{RESET}$  (RESET) open.

**Note 3:** Threshold voltage is specified for  $V_{DD}$  falling.

**Note 4:** Standard version for  $t_{POR}$  is 200ms (typ). Other option (1.6ms, 25ms, 1600ms) are available by mask option and upon minimum order quantity. Please contact EM sales.

**Note 5:** Pulse width must be greater than  $1\mu s$  to ensure the  $\overline{RESET}$  (RESET) to go active.

**Note 6:** Standard version for  $t_{WD}$  is 1600ms (typ). Other option (6.2ms, 102ms, 25.6s) are available by mask option and upon minimum order quantity. Please contact EM sales.

## Timing Waveforms

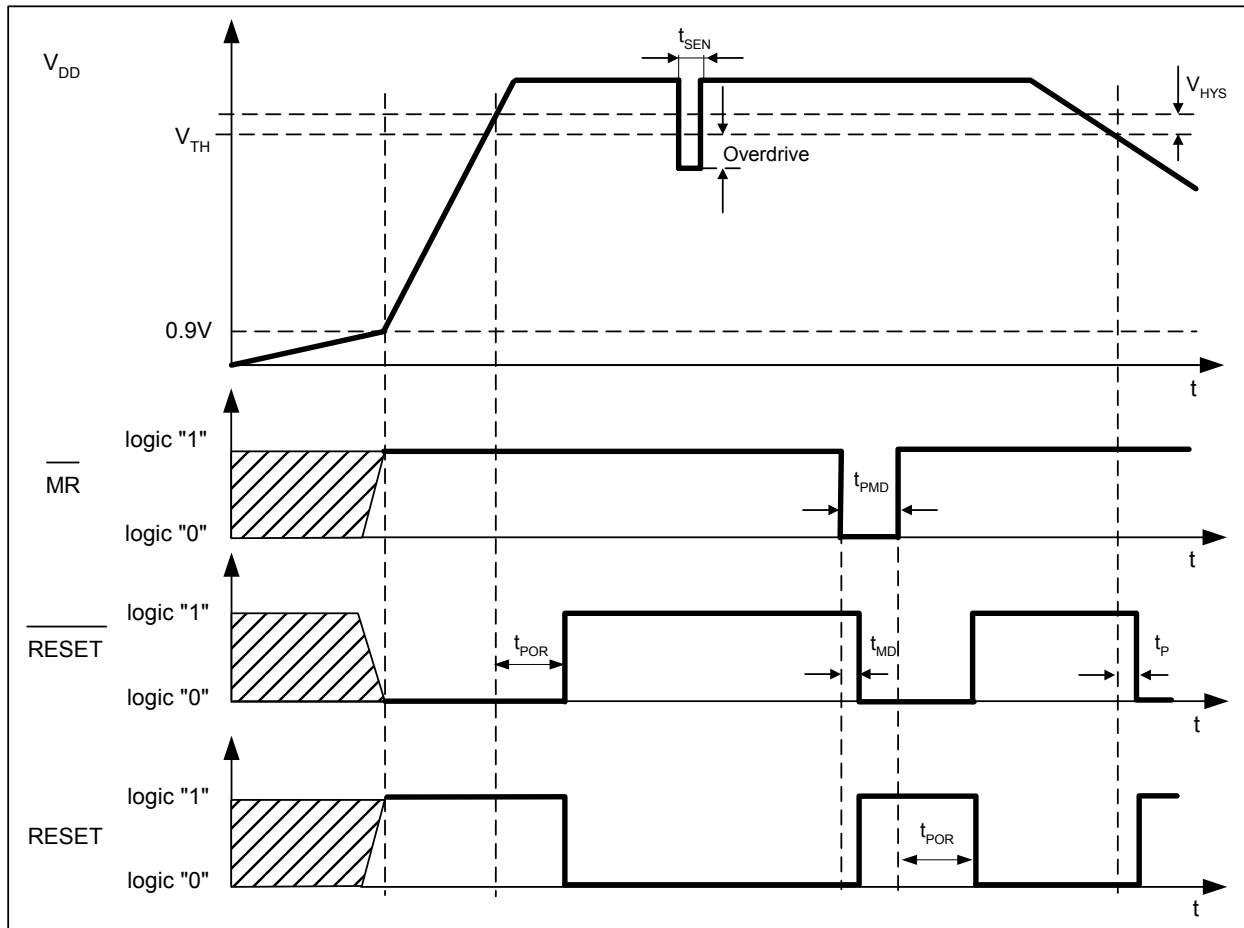

Fig. 4

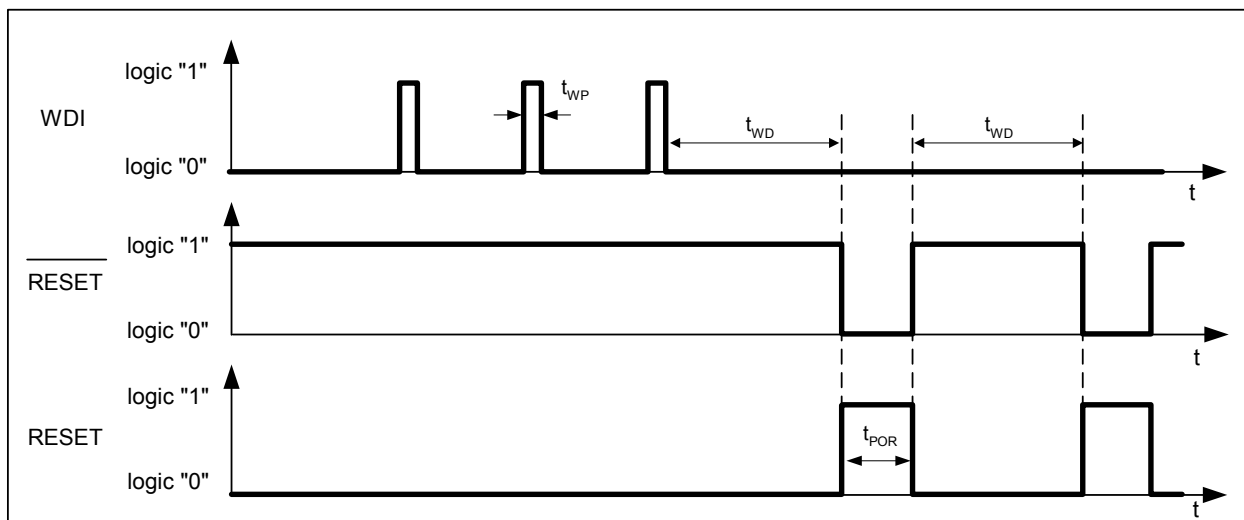

Fig. 5

**Note 7:**  $t_{SEN}$  = Maximum Transient Duration. Please refer to figure on the next page.

**Note 8:** Overdrive =  $V_{TH} - V_{DD}$ . Please refer to figure on the next page.

## Typical Operating Characteristics

(Typical values are at  $T_A=+25^\circ\text{C}$  unless otherwise noted. WDI,  $\overline{\text{MR}}$ ,  $\overline{\text{RESET}}$  and RESET open.)

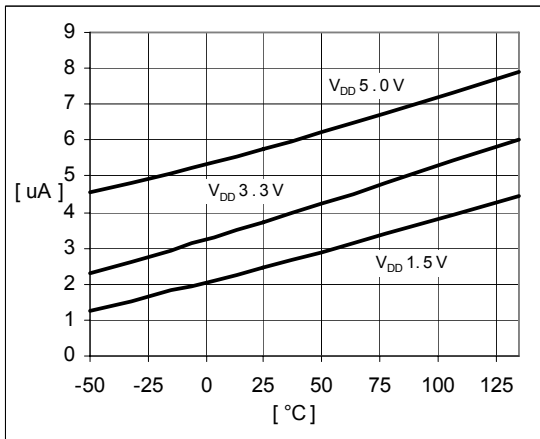

Fig. 6  
 **$I_{DD}$  vs. Temperature**

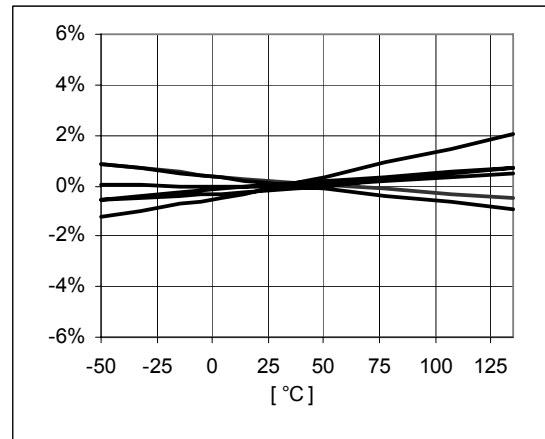

Fig. 7  
**Threshold Voltage Variation vs. Temperature (normalized)**

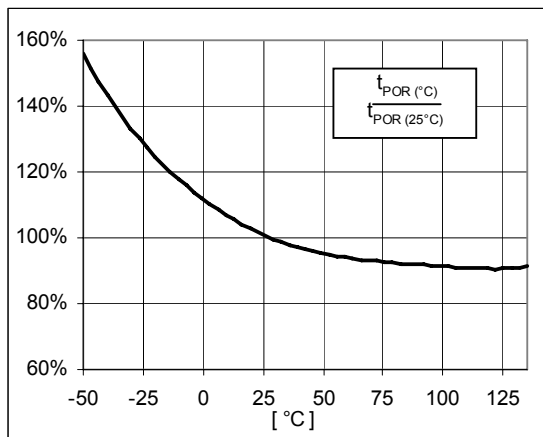

Fig. 8  
**Reset Timeout Period  $t_{POR}$  vs. Temperature (normalized with respect to  $t_{POR\ 25^\circ\text{C}}$ )**

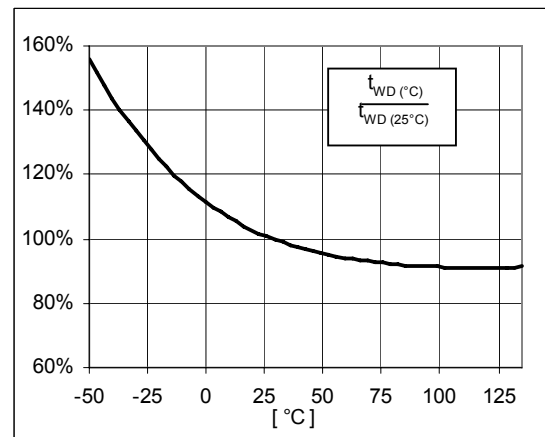

Fig. 9  
**Watchdog Timeout Period  $t_{WD}$  vs. Temperature (normalized with respect to  $t_{WD\ 25^\circ\text{C}}$ )**

## Typical Operating Characteristics

(Typical values are at  $T_A=+25^\circ\text{C}$  unless otherwise noted. WDI,  $\overline{\text{MR}}$ ,  $\overline{\text{RESET}}$  and RESET open.)

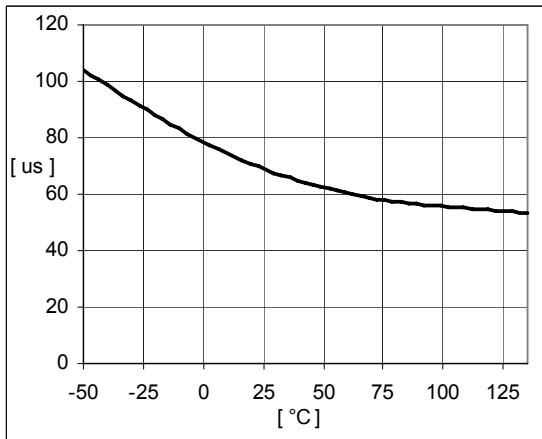

Fig. 10

**Propagation Time  $t_{\text{PHL}}$  vs. Temperature**

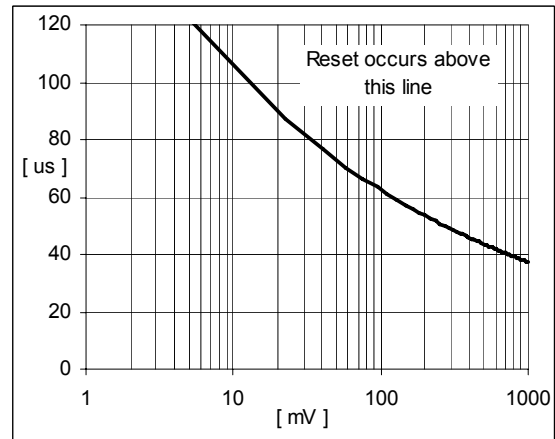

Fig. 11

**Maximum Transient Duration  $t_{\text{SEN}}$  vs. Overdrive  $V_{\text{TH}}-V_{\text{D}}$**

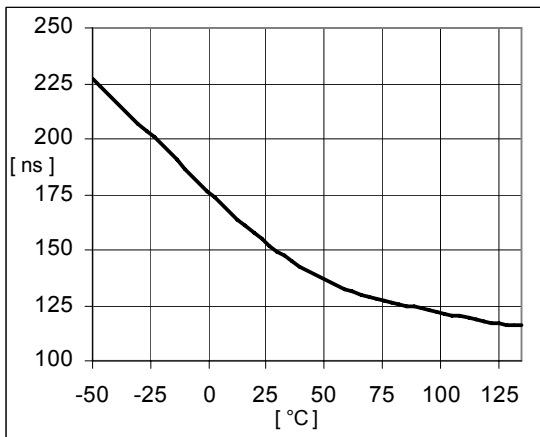

Fig. 12

**Watchdog Input Pulse Width  $t_{\text{WP}}$  vs. Temperature**

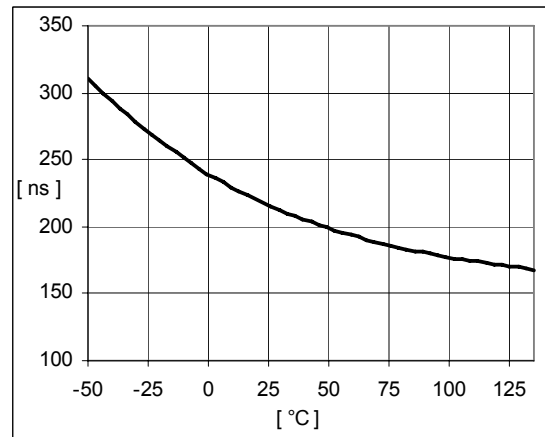

Fig. 13

**Manual Reset Pulse Width  $t_{\text{PMD}}$  vs. Temperature**



## Functional Description

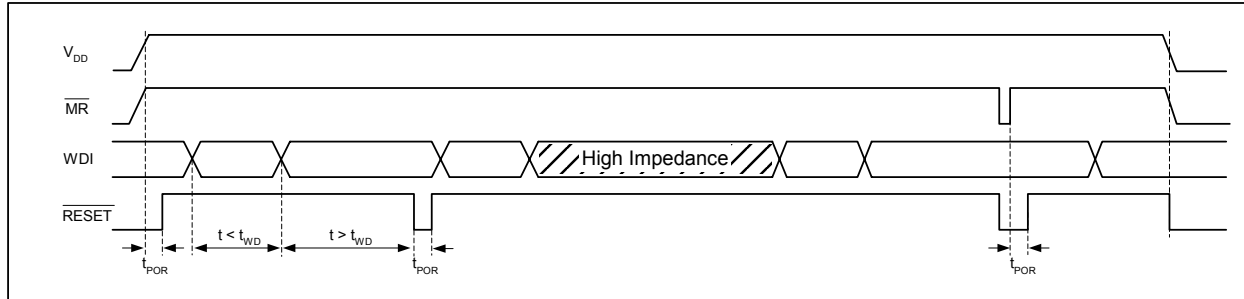

Fig. 14

### Reset Outputs

A microprocessor ( $\mu\text{P}$ ) reset input starts the  $\mu\text{P}$  in a known state. The EM6323/24  $\mu\text{P}$  supervisory circuits assert a reset to prevent code-execution errors during power-up, power-down, and brownout conditions.  $\overline{\text{RESET}}$  is guaranteed to be a logic low for  $V_{\text{DD}}$  down to 0.9V. Once  $V_{\text{DD}}$  exceeds the reset threshold, an internal timer keeps  $\overline{\text{RESET}}$  low for the specified reset timeout period ( $t_{\text{POR}}$ ); after this interval,  $\overline{\text{RESET}}$  returns high. If a brownout condition occurs ( $V_{\text{DD}}$  dips below the reset threshold),  $\overline{\text{RESET}}$  goes low. Each time  $\overline{\text{RESET}}$  is asserted it stays low for the reset timeout period. Any time  $V_{\text{DD}}$  goes below the reset threshold the internal timer restarts.  $\overline{\text{RESET}}$  is the inverse of RESET.

### Manual Reset Input (EM6323 only)

A logic low on  $\overline{\text{MR}}$  asserts a reset. Reset remains asserted while  $\overline{\text{MR}}$  is low, and for  $t_{\text{POR}}$  (200ms nominal for EM6323 C-G-L-Q) after it returns high.  $\overline{\text{MR}}$  has an internal 30k $\Omega$  pull-up resistor, so it can be left open if unused. This input can be driven with CMOS logic levels or with open-drain outputs. Connect a normally open momentary switch from  $\overline{\text{MR}}$  to  $V_{\text{SS}}$  to create a manual-reset function; debounce circuitry is integrated. If  $\overline{\text{MR}}$  is driven from long cable or the device is used in a noisy environment, connect a 0.1 $\mu\text{F}$  capacitor from  $\overline{\text{MR}}$  to  $V_{\text{SS}}$  to provide additional noise immunity (stronger external additional pull-up resistor can also be added).

## Watchdog Input

If the watchdog timer has not been cleared within  $t_{WD}$  (1.6s typ.), reset asserts. The internal 1.6s timer is cleared by either a reset pulse or by toggling WDI. While reset is asserted, the timer remains cleared and does not count. As soon as reset is released, the timer starts counting.

If the microcontroller I/O connected to WDI is put in a high impedance condition, the circuit will detect this condition as a microcontroller in sleep mode and prevent its watchdog from timing out. To monitor a high impedance or a three state condition on WDI, the watchdog input is internally driven low during the first 15/16 of the watchdog timeout period and high for the last 1/16 of the watchdog timeout period.

When WDI is left unconnected, this internal driver clears the 1.6s timer every 1.5s. When WDI is three-stated or unconnected, the maximum allowable leakage current is  $0.5\mu A$ .

To minimized the overall system power consumption and therefore for a minimum watchdog input current leave WDI low for the majority of the watchdog timeout period, pulsing it low-high-low once within the first 15/16 of the watchdog timeout period to reset the watchdog timer. If WDI is externally driven high for the majority of the timeout period, up to  $35\mu A$  can flow into WDI. Meanwhile when the microcontroller is not in sleep mode, the output of the microcontroller which drives WDI has to be strong enough to fight the  $35\mu A$ .

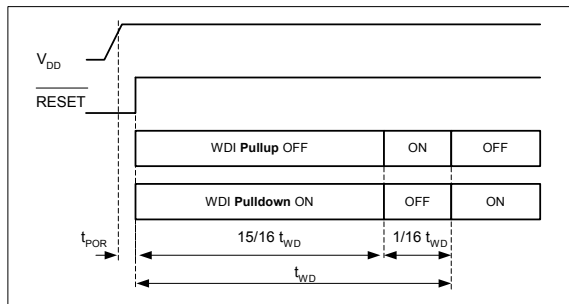

Fig. 15

**WDI Input Timing Diagram**

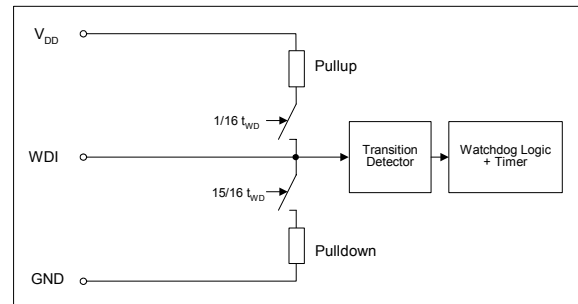

Fig. 16

**WDI Input Stage Block Schematic**

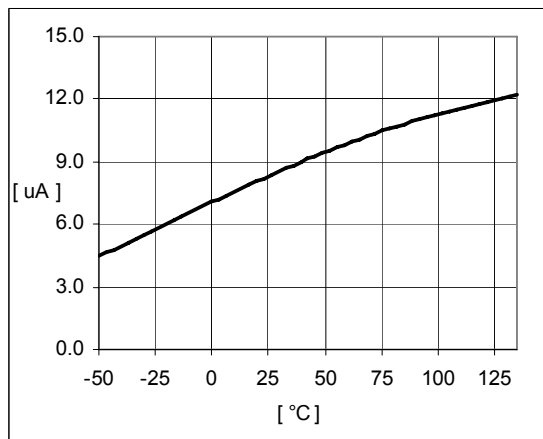

Fig. 17

**WDI Input Current Low-level  $I_L$  vs. Temperature ( $V_{DD}=5.5V$ )**

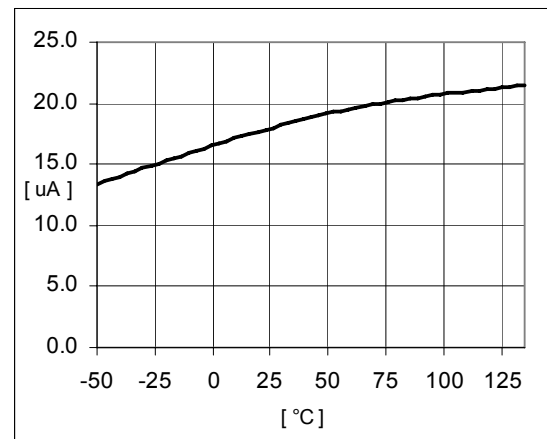

Fig. 18

**WDI Input Current High-Level  $I_H$  vs. Temperature ( $V_{DD}=5.5V$ )**

## Package Information

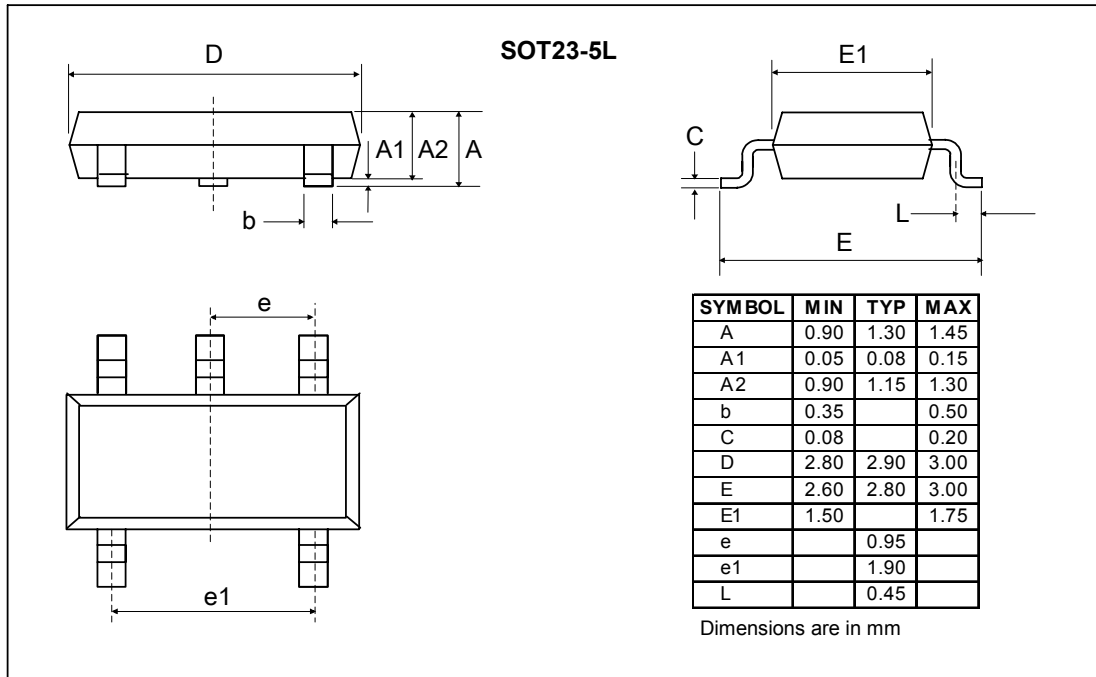

Fig. 19

### Traceability for small packages

Due to the limited space on the package surface, the bottom marking contains a limited number of characters that provide only partial information for lot traceability. Full information for complete traceability is however provided on the packing labels of the product at delivery from EM. It is highly recommended that the customer insures full lot traceability of EM product in his final product.

EM Microelectronic-Marin SA (EM) makes no warranty for the use of its products, other than those expressly contained in the Company's standard warranty which is detailed in EM's General Terms of Sale located on the Company's web site. EM assumes no responsibility for any errors which may appear in this document, reserves the right to change devices or specifications detailed herein at any time without notice, and does not make any commitment to update the information contained herein. No licenses to patents or other intellectual property of EM are granted in connection with the sale of EM products, expressly or by implications. EM's products are not authorized for use as components in life support devices or systems.

Product qualification is performed according to internal EM quality standards for industrial products. For any special requirement (eg. automotive grade) please contact EM Microelectronic-Marin S.A.