

MU9C Routing CoProcessor (RCP) Family

APPLICATION BENEFITS

- Longest Prefix Match searches of IPv4 addresses
- 28 Million IPv4 packets per second supports up to 18 Gb Ethernet or 7 OC-48 ATM ports at wire speed
- Longest Prefix Match searches of IPv4 addresses
- Exact match on MAC addresses
- Processes DA and SA within 190 ns, supporting three ports of 1 Gb or 34 ports of 100 Mb Ethernet at wire speed
- Mixed mode L3 and L2 single search engine for two ports at 1 Gb or 29 ports of 100 Mb Ethernet at wire speed
- Directly addresses external RAM containing associated data of any width
- Hardware control states directly address memory and registers; Instruction and Status registers for optional software control

DISTINCTIVE CHARACTERISTICS

- 4K and 8K x 64-bit words
- 32-bit ternary or 64-bit binary compares
- 64-bit per word memory organization
- 35 ns deterministic compare and output time
- 32-bit Data I/O port
- 16-bit Match Address Output port
- Address/Control bus directly controls device operations for faster operation or higher throughput
- Seven selectable mask registers
- Synchronous operation
- Cascadable for increased depth
- Extensive set of control states for flexibility
- JTAG interface
- 100-pin and 128-pin LQFP packages; 3.3 Volt operation (also available in lead-free packages)

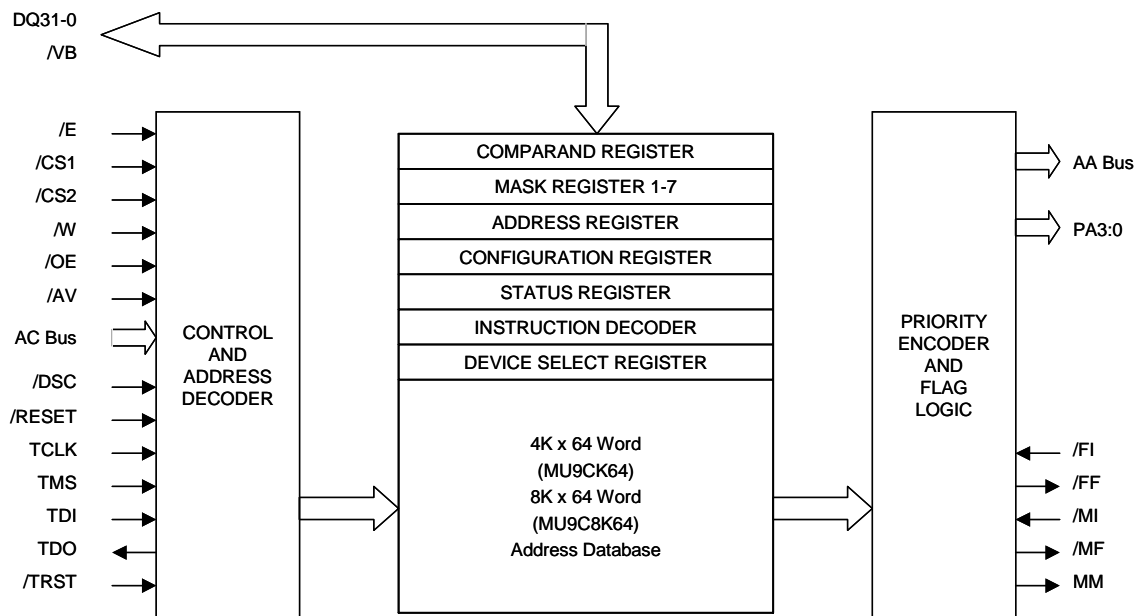

Figure 1: Block Diagram

GENERAL DESCRIPTION

The MU9C RCP family consists of 4K and 8K x 64-bit Routing CoProcessors (RCPs) with a 32-bit wide data interface and a 32-bit ternary compare instruction. The device is designed for use in layer 3 switches, routers, and layer 2 switches to provide very high throughput address translation using tables held in external RAM. The MU9C RCP has a fully deterministic search time, independent of the size of the list and the position of the data in the list. This unique feature guarantees that the wire speed address recognition does not impact the latency or induce some jitter on the latency of the global system. Address fields from the packet header are compared against a list of entries stored in the array. As a result of the comparison,

the MU9C RCP generates an index that is used to access an external RAM where port mapping data and other associated information is stored.

A set of control states provides a powerful and flexible control interface to the MU9C RCP. This control structure allows memory read and write, register read and write, data move, comparison, validity control, addressing control, and initialization operations.

The MU9C RCP architecture uses direct hardware control of the device and an independent bus for returning match results. Software control is also supported for systems where maximum performance is not needed.

OPERATIONAL OVERVIEW

The MU9C RCP is designed to act as an address translator for lookup tables in layer 3 switches, routers, and layer 2 switches. Refer to Figure 2 for a simplified block diagram of a switch. During normal operation, the controller extracts the address information from an arriving packet to form the comparand, which is then compared against the contents of the MU9C RCP. The MU9C RCP generates an index that is used to access the data in an external RAM, which holds the destination port for accessing the network. The controller reads the data from the RAM and forwards the packet.

A unique feature of the MU9C RCP is its ternary comparison that processes IPv4 CIDR addresses in a single cycle. The bits of each MU9C RCP word are paired, such that each pair can contain two binary values (0,1) or one ternary (0,1,X="Don't Care") value. A ternary value uses two bits, pairing bit n from the first 32 bits (31-0) with bit $n+32$. When storing a ternary 0 or 1, the value to be stored is written into bit n ($0 \leq n \leq 31$), and the complement of the value is written to bit $n+32$. Thus, a ternary 0 written to ternary pair 7 would consist of a 0 stored in bit 7 and a 1 stored in bit 39. When storing a ternary X, 0 is written to both bits in the pair.

Using bit pairs that are 32 bits apart simplifies the computation of the pair by a processor. Assume that the ternary value we wish to store is contained in two 32-bit processor words. Word A contains the value to be stored and word M contains a mask value, with a 0 in each position at which an X is to be stored. The value to be written to bits 31-0 of the MU9C RCP is (A&M) and the value to be written to bits 63-32 of the MU9C RCP is (~A&M).

A special instruction, CMPT DQ, performs the ternary comparison processing for IPv4 CIDR addresses. The data on the DQ bus are used directly as both the comparand and compare mask bits 31-0, and the one's complement of the DQ bus data are used as both the comparand and compare mask

bits 63-32. As a result, this instruction matches a DQ bit of 0 with bit pairs storing both 0 and X, and a DQ bit of 1 matches bit pairs storing both 1 and X.

IPv4 CIDR addresses are prioritized by placing their ternary-encoded values into the MU9C RCP memory such that entries with longer netmasks (longer matches) have higher priority (lower indices). Thus, when the MU9C RCP performs a ternary comparison, it will return the index of the longest matching entry. Typically, the system is initialized by a processor that writes routing table information into the MU9C RCP. The index at which a write takes place is driven onto the PA:AA bus, so that output port data can be written simultaneously into the external RAM at the correct index.

The validity of a location in the Address Database is determined by an extra bit called the Validity bit. This bit is set and reset either with an index or an associative match. Therefore, when a new entry is written to the database, its Validity bit is set valid.

When a database location is deleted, the Validity bit for that entry is reset, and the index of the location is driven onto the Active Address bus. This simple mechanism allows easy maintenance of the tables in both the database and the external RAM.

The MU9C RCP supports simple daisy chained vertical cascading that serves to prioritize multiple devices and provides system-level match and full indication. If the slight timing overhead associated with the daisy chain is unacceptable, the MU9C RCP is designed to facilitate external prioritization across multiple devices.

For layer 2 applications, the MAC addresses are processed in a binary mode, and the MU9C RCP looks for an exact match. An MU9C RCP can be used to process both MAC addresses and IPv4 CIDR in the same device.

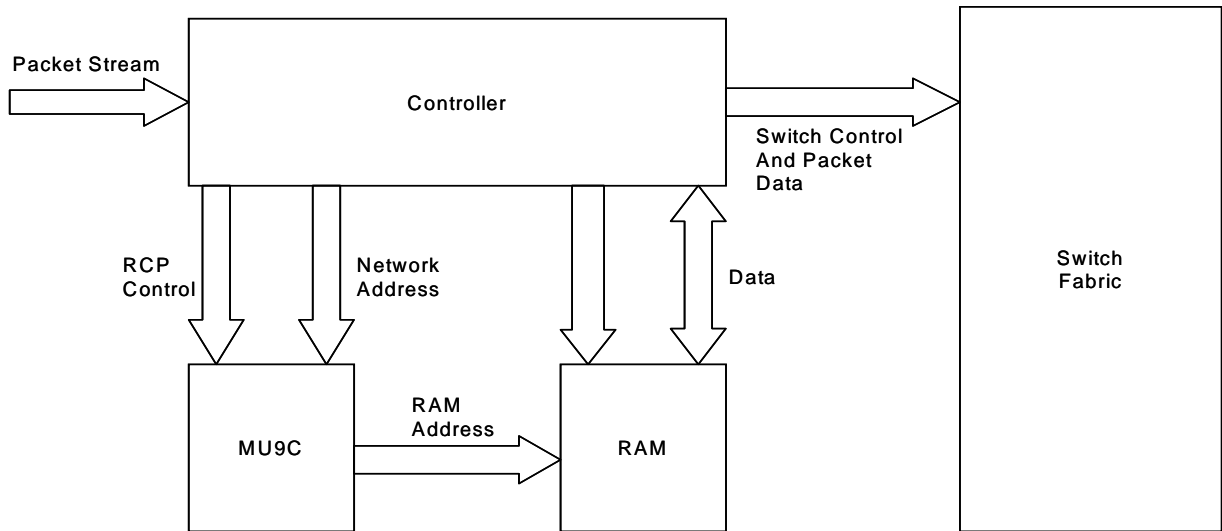

Figure 2: Switch Block Diagram

PIN DESCRIPTIONS

Note: Signal names that start with a slash ("/") are active LOW. All signals are 3.3V CMOS level. Never leave inputs floating. The CAM architecture draws large currents during compare operations, mandating the use of good layout and bypassing techniques. Refer to the Electrical Characteristics section for more information.

DQ31-0 (Data Bus, Three-state, Common Input/ Output)

The DQ31-0 lines convey data to and from the MU9C RCP. When the /E input is HIGH the DQ31-0 lines are held in their high-impedance state. The /W input determines whether data flows to or from the device on the DQ31-0 lines. The source or destination of the data is determined by the AC bus, DSC, and the /AV line. During a Write cycle, data on the DQ31-0 lines is registered by the falling edge of /E.

AC12-0/AC11-0 (Address/Control Bus, Input)

When Hardware control is selected, the AC bus conveys address or control information to the MU9C RCP, depending on the state of the /AV input. When /AV is LOW then the AC bus carries an address; when /AV is HIGH the AC bus carries control information. Data on the AC bus is registered by the falling edge of /E. When software control is selected, the state of the AC bus does not affect the operation of the device.

DSC (Data Segment Control, Input)

When DQ bus access to a 64 bit register or memory word is performed, the DSC input determines whether bits 31-0 (DSC LOW) or bits 63-32 (DSC HIGH) are accessed. Access to 32 bit registers require that DSC be held LOW.

AA12-0/AA11-0 (Active Address, Output)

The AA bus conveys the Match address, the Next Free address, or Random Access address, depending on the most recent memory cycle. The /OE input enables the AA bus; when the /OE input is HIGH, the AA bus is in its high-impedance state; when /OE is LOW the AA bus is active. In a vertically cascaded system after a Comparison cycle, Write at Next Free Address cycle or Read/Write at Highest-Priority match, only the highest-priority device will enable its AA bus, regardless of the state of the /OE input. In the event of a mismatch in the Address Database after a Compare cycle, or after a Write at Next Free Address cycle into an already full system, the lowest-priority device will drive the AA bus with all 1s. The AA bus is latched when /E is LOW, and are free to change only when /E is HIGH.

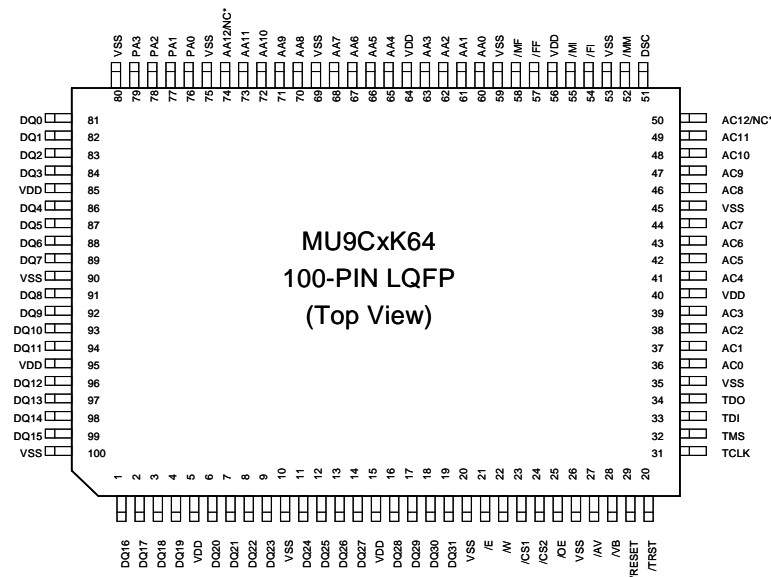

* NC on MU9C4K64

Figure 3: MU9C RCP 100-LQFP Pinout

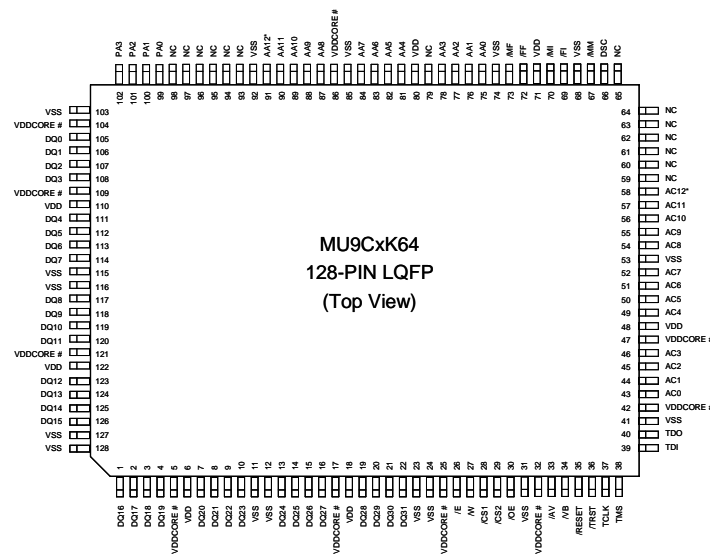

* NC on MU9C4K64
See Pin Description for VDDCORE

Figure 3b: MU9C RCP 128-LQFP Pinout

PA3-0 (Page Address, Output)

The PA3-0 lines convey Page Address information. When the /OE input is HIGH, the PA3-0 outputs are in their high-impedance state; when /OE is LOW the PA3-0 lines carry the Page Address value held in the Configuration register. The PA3-0 lines are latched when /E is LOW, and are free to change only when /E is HIGH. The Page Address value of the currently active or highest-priority responding device is output at the same time, and under the same conditions, as the AA bus is active.

/E (Chip Enable, Input)

The /E input is the main chip enable and synchronizing control for the MU9C RCP. When /E is HIGH, the chip is disabled and the DQ31-0 lines are held in their high-impedance state. The falling edge of /E registers the /W, /CS1, /CS2, /AV, /AC bus, DSC, and the /VB and DQ31-0 lines for a Write cycle. /E being LOW causes the results of the previous comparison or memory access to be latched on the PA:AA bus; when /E goes HIGH the latches opens allowing the new comparison results or random access memory address to flow to the PA:AA bus.

/CS1, /CS2 (Chip Select 1, Chip Select 2, Inputs)

The /CS1 and /CS2 inputs enable the MU9C RCP. If either /CS1 or /CS2 are LOW, the device is selected for a Read, Write, or Compare cycle through the DQ31-0 lines, or for an internal data transfer. The /CS1 and /CS2 lines do not have any effect on the PA:AA bus. The state of the /CS1 and /CS2 lines is registered by the falling edge of /E.

/W (Write Enable, Input)

The /W input determines the direction of data transfer on the DQ31-0 lines during Read, Write, and Data Move cycles. When /W is LOW, data flows into the DQ31-0 lines; when /W is HIGH, data flows out. The /W line also conditions the control state present on the AC bus and DSC lines. The state of the /W line is registered by the falling edge of /E.

/OE (Output Enable, Input)

The /OE input enables the PA:AA bus. When /OE is HIGH, PA:AA bus are in their high-impedance state. When /OE is LOW, PA:AA bus are active, and convey the results of the last Comparison Cycle Match address or Memory Access address. In a vertically cascaded system, only the PA:AA bus of the highest-priority device will be activated by /OE being LOW; in lower-priority devices, the PA:AA bus remains in high-impedance regardless of the state of /OE.

/AV (Address Valid, Input)

When Hardware control is selected, the /AV input determines whether the AC bus carries address or control information. When /AV is LOW, the AC bus conveys a memory address; when /AV is HIGH, the AC bus conveys control information. The state of the /AV line is registered by the falling edge of /E. When software control is selected, the /AV line distinguishes between instructions and data on the DQ31-0 lines; when /AV is LOW, data is present on the DQ31-0 lines; when /AV is HIGH, an instruction is present on the DQ11-0 lines.

/VB (Validity Bit, Three-state, Common Input/Output)

During accesses over the DQ31-0 lines, the /VB line conveys validity information to and from the MU9C RCP. During a Write cycle (/W=LOW), when /VB is LOW the addressed location is set valid; when /VB is HIGH it is set empty. During a Read cycle (/W=HIGH), the validity of the addressed location is read on the /VB line. During a Write cycle, the state of the /VB line is registered by the falling edge of /E.

/MF (Match Flag, Output)

The /MF output indicates whether a valid match has occurred during the previous Comparison cycle. If the /MF output is HIGH at the end of a Comparison cycle, then no match occurred; if it is LOW then either a match occurred within the device, or the /MI input is LOW, conditioned by the /MF output from a higher-priority device in the system. The state of the /MF line will not change until after the rising edge of /E during the Comparison cycle. Note that /MF indicates the results of the most recent Comparison cycle; it will not change when the PA:AA bus carry an address other than the Match address.

/MI (Match Input, Input)

The /MI input receives match information from the next higher-priority MU9C RCP in a vertically cascaded system to provide system-level prioritization. When the /MI input is HIGH, the /MF output will only go LOW if there is a match during a Comparison cycle; when the /MI input is LOW, the /MF output will go LOW. The /MF output from one device is connected to the /MI input of the next lower-priority device. The /MI pin of the highest-priority device must be tied HIGH.

/FF (Full Flag, Output)

The /FF output indicates when all the memory locations have their Validity bits set valid (LOW). When there is at least one location with its Validity bit set HIGH, the /FF output will be HIGH; when all locations have their Validity bits set LOW, and the /FI input is LOW, the /FF output will be LOW. If the /FI input is HIGH, the /FF output will be HIGH. The state of the /FF line will not change until after the rising edge of /E during a Write cycle.

/FI (Full Input, Input)

The /FI input receives full information from the next higher-priority MU9C RCP in a vertically cascaded system to provide system-level full information. When the /FI input is LOW the /FF output will be HIGH if there is at least one location whose Validity bit is set invalid; when all locations have their Validity bits set valid, the /FF output goes LOW. When the /FI input is HIGH, the /FF output will remain HIGH. The /FF output from one device is connected to the /FI input of the next lower-priority device to give system-full indication. The /FI pin of the highest-priority device must be tied LOW.

/MM (Multiple Match, Open Drain Output)

The /MM line indicates that there is a multiple match within the system. When the /MI input is HIGH, the /MM line is pulled LOW if there are at least two matches within the MU9C RCP as a result of the previous Comparison cycle; when there are less than two matches, the /MM line floats HIGH. When the /MI input is LOW, the /MM line is pulled LOW if there are one or more matches within the MU9C RCP as a result of the previous Comparison cycle; when there are no matches, the /MM line floats HIGH. The /MM lines have open-drain outputs, so all /MM lines within the system are connected together to give system-level multiple match indication. The state of the /MM line will not change until after the rising edge of /E during a Comparison cycle.

/RESET

The /RESET input is used to reset the MU9C RCP to a known state. When the /RESET line is pulled LOW it causes the MU9C RCP to enter its reset state. After power is applied to the MU9C RCP, the /RESET line must be held LOW for a time equal to or greater than the minimum RESET pulse width before the device can operate correctly. This pin is internally pulled up.

TCLK (JTAG Test Clock, Input)

The TCLK input is the Test Clock input. This pin is internally pulled up.

TMS (JTAG Test Mode Select, Input)

The TMS input is the Test Mode Select input. This pin is internally pulled up.

TDI (JTAG Test Data Input, Input)

The TDI input is the Test Data input. This pin is internally pulled up.

TDO (JTAG Test Data Output, Output)

The TCLK output is the Test Data Output. This pin is internally pulled up.

/TRST (JTAG Reset, Input)

The /TRST input is the Reset input, and serves to reset the Test Access Port circuitry to its reset condition. This pin is internally pulled up.

VDD, VSS (Positive Power Supply, Ground)

These pins are the main power supply connections to the MU9C RCP. VDD must be held at +3.3 Volts and ± 0.3 Volts relative to the VSS pin, which is at 0 Volts, system reference potential, for correct operation of the device.

VDDCORE (Core Supply Voltage)

These pins are No Connect (NC) on current products. Reserved for future products and upgrades. VDDCORE is 1.3 Volts.

Note: The TCLK, TMS, TDI, TDO, and /TRST lines are defined in the IEEE Standard Test Access Port and Boundary-scan Architecture IEEE Standard. 1149.1-1990 and IEEE Standard. 1149.1a-1993.

FUNCTIONAL DESCRIPTION

Data is read from and written to the MU9C RCP through the DQ31-0 lines. The Control bus, which is comprised of Chip Enable (/E), two Chip Selects (/CS1, /CS2), Write Enable (/W), Output Enable (/OE), Validity Bit Control (/VB), Address Valid (/AV), Data Segment Control (DSC), and the Address/Control inputs (AC bus) controls the MU9C RCP. When the /AV line is LOW, the AC bus carries an address for random access into the Memory array; when it is HIGH, the AC bus conveys control information. The MU9C RCP control states perform Register Read/Write, Memory Read/Write, Data Move, Comparison, Validity Bit Control, Initialization, and Address Register Control. These functions are summarized in Control State Overview on page 17.

Random access to memory locations occurs when the /AV line is LOW; during a Write cycle, the validity of the location is set by the /VB input. When the /AV line is HIGH the control states allow read and write access to the register set comprising Comparand register, seven mask registers, a Configuration register, a Status register, an Address register, a Device Select register, and an Instruction register. The Configuration register sets the persistent operating conditions of the device: the Page address of the device, selection of mask register for directly addressed memory writes, and selection between hardware and software control.

When Hardware control is selected, control is through the AC bus and DSC line. When Software control is selected, control is through the Instruction register, which is loaded from the DQ bus. Under software control the /AV line is used to distinguish between data and an instruction on the DQ bus. Therefore, in Software Control mode, random access to the Memory array can take place only using indirect addressing through the Address register.

The two Chip Select lines /CS1, /CS2 enable the device and simplify access to a multi-chip system, if either Chip Select line is LOW the device is selected. The MU9C RCP also can be selected through the Device Select register when its value is set to that of the Page address of the device, and the enable bit in the Device Select register is set LOW. The /OE input enables the output signal and is used to synchronize devices in a multi-chip system, and to prevent race conditions among devices during priority resolution.

The output signals comprise the Active address (AA bus), and the Page address (PA bus). The PA:AA bus provides the current Active address, which is either the Match address, Next Free address, or the Random Access address, concatenated with the Device Page address. The source of Active address is dependent on the previous

control state, allowing access to associated data in the external RAM at the same location as an access in the MU9C RCP for all types of cycles.

The Output enable, /OE, controls the PA:AA bus: when it is LOW after a Compare cycle, the highest-priority responding device outputs its Page and Match addresses on PA:AA bus. Only the highest-priority responding device is enabled, all other lower-priority devices will have their PA:AA bus in the high-impedance state, regardless of the state of their respective /OE lines: when /OE is HIGH, the PA:AA remain in the high-impedance state.

When a mismatch occurs in the system, the lowest-priority device, as defined in the Configuration register, will drive the PA:AA bus with all 1s. When any Read or Write cycle occurs, the address of the accessed location is output on the PA:AA bus. The address output on the PA:AA bus is persistent, and is held latched until /E goes HIGH during the next cycle that changes the Active address. The PA:AA bus is free to change only while /E is HIGH. Once /E goes LOW, the state of the PA:AA bus is latched.

After a Compare cycle, the /MF and /MM flags are free to change after /E has gone HIGH. Once the Match Flag daisy chain has resolved device prioritization, the /OE lines can be asserted to enable the PA:AA bus from the highest-priority matching device.

In a multi-chip system, when a device remains deselected during a Compare cycle through /CS1 and /CS2 being HIGH and there being no match between the Device Select register and the Page Address register, that device will clear any previous positive match results. In other words, if it had previously been indicating a match from an earlier Comparison cycle, it will now be set to indicate a mismatch, even though it was not selected during the most recent Compare cycle.

For pure software control of the MU9C RCP, instructions can be loaded into the Instruction register, and results read from the Status register. The Status register holds the results of comparison: PA:AA bus, /MF, /FF, and /MM plus two PA:AA Validation bits that indicate the type of cycle that generated the PA:AA bus value.

Vertical cascading is supported through a daisy chain architecture. There are two daisy chains, one each for the Match flag and the Full flag; the Multiple Match flag is connected between devices through an open-drain line. The Match flag (/MF) from a higher-priority device is connected to the Match input (/MI) of the next lower-priority device to provide prioritization throughout a multiple device system. The /MF output from the

lowest-priority device provides a system Match flag. If the delay through the daisy chain is unacceptable, the /OE input can be used by external priority-resolution circuitry to enable the highest-priority responder in the system.

The match conditions on the Match and Multiple Match flag lines are persistent indicating the results of the most recent Compare cycle. The Match flags are free to change after the rising edge of /E during a Compare cycle, at which time the daisy chain starts to resolve device prioritization. Once the daisy chain has settled, the /OE lines can be pulled LOW to access the Highest-Priority Match address on the PA:AA bus.

The Multiple Match open-drain output (/MM) provides multiple match indication when there are two or more matches in a single device, or a device has its /MI input LOW and has a match; the /MM flags of all devices in the

system are wire-ORed. Multiple responders can be accessed sequentially by resetting the Highest-Priority Match latch with the control state Advance to Next Matching Location.

The Full flag (/FF) is cascaded from one device to the Full Flag input (/FI) of the next lower-priority device in the system. The /FF output from the lowest-priority device provides a system Full flag. The Full flag is free to change after the rising edge of /E during a Write cycle. The daisy chains are persistent and are not conditioned by the /OE input.

The MU9C RCP supports JTAG boundary-scan testing through the pins TCK, TMS, TDI, TDO, and /TRST, according to the IEEE 1149 Standard: Test Access Port and Boundary-scan Architecture.

OPERATIONAL CHARACTERISTICS

Processor Interface

The processor interface is through a 32-bit data bus DQ31-0 and control signals comprised of Chip Enable (/E), two Chip Selects (/CS1, /CS2), Write Enable (/W), Output Enable (/OE), Validity Bit Control (/VB), Address Valid (/AV), Data Segment Control (DSC), and Address/Control inputs (AC bus). When the /AV line is LOW, the DSC and AC bus carries an address for random access into the Memory array; when it is HIGH, the AC bus conveys control information.

Most of the functionality of the MU9C RCP is accessed through the control states on DSC and AC bus when /AV is HIGH. The processor maps the control structure into memory space and controls the MU9C RCP through memory Read and Write cycles. Using this memory mapping scheme, the /AV line should be driven from logic that generates a HIGH level within the mapped range of the control states, and a LOW level outside it. Other control inputs /E, /W, /CS1, and /CS2 are analogous to SRAM control inputs.

The /VB line acts like an extra data bit during memory Read and Write cycles and is used to read and write the validity of any memory location.

The MU9C RCP is enabled either through hardware through /CS1 or /CS2 being LOW, or it is enabled by the value written to the Device Select register matching with the Page Address field of the Configuration register. One extra bit in the Device Select register enables the comparison between the Page Address value and the Device Select register. These Chip Select mechanisms operate in parallel. If any one is active, the device is enabled.

The MU9C RCP can be controlled directly through software. The Software Control mode is selected through settings in the Configuration register.

When the Software Control mode is selected, control states are written to the Instruction register from DQ11-0 during a Write cycle with the /AV line held HIGH. DQ12 acts as the DSC input. If the control state does not involve any data transaction on the DQ31-0 lines, the instruction is executed during the same cycle; the state of DQ13 modifies the instruction, its state is equivalent to the /W input.

Note: It is up to the system designer to ensure that the correct cycle type follows the loading of an instruction in Software Control mode. If the instruction expects a Read cycle, and a Write cycle is executed, or vice versa, the function of the MU9C RCP is undefined. Such an error may lead to data loss, but will not damage the device physically.

A Read cycle with the /AV line HIGH will access the Status register, allowing results to be read back without loading a new instruction. After a Comparison cycle, Write at Next Free Address cycle or Read/Write at Highest-Priority match in a vertically cascaded system, only the highest-priority device will enable its DQ31-0 lines and output the contents of its Status register. After a Comparison cycle, in the event of a mismatch in the MU9C, the DQ31-0 lines of the lowest-priority device will be enabled. After a random access Read or Write cycle, the Status register of any selected device will be enabled. Under these circumstances, it is up to the user to ensure that only a single device is enabled through /CS1, /CS2, or the Device Select register.

The instruction is persistent, so that all subsequent data transactions will be executed according to the control state held in the Instruction register. The results of a Comparison cycle can be read back from the Status register, and include PA:AA bus, /MF, /MM, and /FF. The following sequence of events provides the fastest operation of the MU9C RCP in Software Control mode:

/AV	Operation
1	Load 'Compare DQ with CAM' instruction
0	Comparand on DQ31-0
1	Read Status Register
0	Next Comparand on DQ31-0
1	Read Status Register, etc.

Note: It is up to the system designer to ensure that the correct cycle type follows the loading of an instruction in Software Control mode. If the instruction expects a Read cycle, and a Write cycle is executed, or vice versa, the function of the MU9C RCP is undefined. Such an error may lead to data loss, but will not damage the device physically.

Hardware Control

Direct hardware control using the AC bus and DSC line enhances performance of the MU9C RCP. The AC bus inputs determine which CAM location is accessed, and the DSC determines whether bits 31-0 (DSC LOW) or bits 63-32 (DSC HIGH) are active. The Hardware Control mode is selected when Configuration Register bits FR27-26 are set LOW. The AC bus inputs are qualified by /W, /AV, and /VB. When /AV is LOW, the AC bus and DSC line carry the address for a random Read or Write cycle, depending on the state of /W, and /VB carries the validity of the location. During a Write cycle, /VB is written to the Validity bit of the addressed location; during a Read cycle, the validity of the location is read on the /VB line. When /VB is LOW, the location contains valid data; when /VB is HIGH the location is empty.

When /AV is HIGH, the AC bus and DSC line carry address and control information. The DSC line selects whether bits 31-0 (DSC LOW) or bits 63-32 (DSC HIGH) participate in the operation. The AC8-6 lines select the mask register and the AC5-0 lines provide the Op-Code. If masking is not used, and all random addressing of the memory is indirect through the Address register, then only the DSC and AC5-0 lines are needed for full control of the device.

In applications where a restricted number of control lines are available, or where speed is not critical, the MU9C RCP can be controlled in Software Control mode where the control states are loaded into the Instruction register through the DQ31-0 lines. The control states are identical in both Hardware and Software Control modes, although DQ12 and DQ13 take on special significance in Software mode.

Software Control

For optimum performance, the AC bus and DSC line control the MU9C RCP, allowing data transactions through the DQ31-0 lines during a control cycle. In cases where the overhead of a separate data load cycle can be accommodated, the MU9C RCP can be operated through the Instruction register. The AC bus and DSC line are not used.

Control through the Instruction register is selected by the FR27-26 bits of the Configuration register being set HIGH. The instruction is loaded from the DQ11-0 lines (with DSC on DQ12) into the Instruction register during a Write cycle with the /AV line HIGH. The instructions are directly analogous to the control states for any operation that does not involve data transfer on the DQ31-0 lines, in which case the instruction is executed during the same cycle as the instruction is loaded. To distinguish between Read and Write control states, DQ13 is used to indicate which type of instruction should be executed. When DQ13 is LOW at the beginning of the cycle, the instruction executed is the Write Cycle instruction (/W = LOW when control state is conveyed on AC bus and DSC); when DQ13 is HIGH at the beginning of the cycle, the instruction executed is the Read Cycle instruction (/W = HIGH when control state is conveyed on the AC bus).

When the instruction calls for data to be written or read from the DQ31-0 lines, the instruction is loaded into the Instruction register during the cycle, and the next Data Read or Write cycle with /AV LOW executes the instruction using the DQ31-0 bus for the data transaction. The instruction is persistent; for example, if no other instruction is loaded into the Instruction Register, subsequent data transactions with the /AV line LOW will be executed according to the instruction currently loaded in the Instruction register. When there is a data access to a memory location on DQ31-0 associated with the instruction, the /VB line carries the validity of that location.

Instructions that involve data transactions on DQ31-0, and are therefore executed on a subsequent Read or Write cycle with the /AV line LOW, are all Read/Write Memory and Read/Write Register instructions, Read Validity, Write PA3-0. All other instructions are executed in a single cycle with the state of DQ13 being interpreted as the state of the /W line during the equivalent hardware control state.

For Read Cycles with the /AV line HIGH, there is a Software Control mode. This mode is selected through the Configuration bits FR27-26. In Software Control mode (FR27-26 = 0b11) a Read cycle with /AV HIGH accesses the Status register.

Active Address Interface PA:AA Bus

The Active Address interface PA:AA bus carries the currently active address. The address source depends on the most recent control state that caused it to change. The possible address sources that are output on PA:AA bus are: Highest-Priority Match address, Next Free address, Read address, and Write address.

PA:AA Bus After a Comparison Cycle

After a Comparison cycle, or access to the Highest-Priority address, the PA:AA bus carries one of the following two possible results:

- The Match address if the Comparison cycle resulted in a match in the MU9C. Only the device containing the highest-priority match enables its PA:AA bus. All other devices with either no match or a lower-priority match, as indicated by the Match Flag daisy chain, keep their PA:AA bus in high-impedance regardless of the state of their /OE inputs.
- All 1s if there was no match in the MU9C. The lowest-priority device, as indicated by bit FR25 in the Configuration register, enables its PA:AA bus and provides the source of all 1s. All other devices will keep their PA:AA bus in high-impedance regardless of the state of their /OE inputs.

PA:AA Bus After a Write at Next Free Address Cycle

After a Write at Next Free Address cycle the PA:AA carries the address that was written to during that cycle. Only the device in which the write occurred enables its PA:AA bus. All other devices keep their PA:AA bus in high-impedance regardless of the state of their /OE inputs.

In the event that the system was full prior to the Write at Next Free Address cycle being executed, so that the write operation was suppressed, the PA:AA carries all 1s. The lowest-priority device, as indicated by bit FR25 in the Configuration register, enables its PA:AA bus and provides the source of all 1s. All other devices keep their PA:AA in high-impedance regardless of the state of their /OE inputs.

PA:AA Bus After a Random Access Read or Write to the CAM

After a random Read or Write cycle to the MU9C, the PA:AA bus carries the address that was accessed during that cycle. Only the device in which the access occurred enables its PA:AA bus. All other devices keep their PA:AA bus in high-impedance regardless of the state of their /OE inputs. Note that the access to the PA:AA bus differs in this respect from the operation of the Status register, which is accessible in any selected device under this particular circumstance.

In the event that the Write cycle was broadcast to multiple devices, all devices that have their /OE lines held LOW will enable their PA:AA bus. Under this circumstance, it is up to the system designer to ensure that only one /OE line is driven LOW to prevent bus contention on the PA:AA bus.

PA:AA Bus Conditions of Operation

.oDuring a control state that does not have any effect on the device address, such as a Write Register cycle, the PA:AA bus remains unchanged. In other words, the state of the PA:AA bus persists until another cycle causes it to change.

.oWhen enabled by /OE being LOW, the PA:AA bus is only free to change while /E is HIGH. When /E goes LOW the PA:AA bus is latched.

.oThe PA:AA bus is enabled when /OE is LOW provided that the previous cycle causes them to be active. When /OE is HIGH, the PA:AA bus is in high-impedance. Note that /OE is asynchronous with respect to /E, and is independent of Chip Select from either /CS1, /CS2, or through the Device Select register, except in the case of non-broadcast random Read and Write cycles to the MU9C.

PA:AA Bus and the Match Flags

The Match flags /MF and /MM reflect the results of the most recent Comparison cycle. During a Comparison cycle, they do not change until after /E has gone HIGH after which they are free to change combinatorially; their state is not latched when /E is LOW. This condition allows some pipelining to occur and is useful in systems with long daisy chains. A Comparison cycle can be followed by another cycle that does not affect the PA:AA bus before the daisy chain is resolved. For example:

```
CMP CR
WR CR
```

The WRL CR control state can be executed before the daisy chain has resolved device prioritization after the CMP CR control state. The /OE then is asserted at a suitable time, depending on the length of the daisy chain. The Match address of the highest-priority responding device then is driven onto the PA:AA bus.

The /MF, /MM lines continue to indicate the results of the most recent match, even when the PA:AA bus carries an

address other than the Match address. This condition allows rapid return to the Match address value on the PA:AA bus lines through a RDL[HPM] cycle, without the daisy chain having to re-resolve device-level prioritization.

PA:AA Bus and the Status Register

The Status Register bits SR15-0 reflect the PA:AA bus under all conditions. The Status Register flags /MF, /MM, and /FF represent the local conditions within the device, and are not conditioned by the /MI and /FI inputs.

After a Comparison cycle, Write at Next Free address, or access to the Highest-Priority Matching device, a Status Register Read cycle is executed in the same device as the active PA:AA bus. In the case of a random access Read or Write cycle, the Status register of any selected device can be accessed by a Read Status Register cycle. The system designer must ensure that a Status Register Read cycle after a random Read or Write cycle is into a single device using Chip Select /CS1, /CS2, or the Device Select register to prevent bus contention on the DQ31-0 bus.

REGISTER DESCRIPTIONS

The Comparand register, seven mask registers, Address register, Configuration register, Status register, Next Free Address register, Device Select register, and Instruction register comprise the register set. Note that all RESERVED bits can be read and written without affecting the operation of the device.

However, for forward compatibility with future product enhancements, system designers should not rely on any particular RESERVED bit having no effect on the operation of the device in future revisions. Therefore all RESERVED bits should be set to logical zero.

The Register Set**Comparand Register**

The 64-bit Comparand register holds the value to be compared with the valid contents of the Address Database array, although the DQ lines can be compared directly, and then optionally written into the Comparand register.

Mask Registers

There are seven 64-bit mask registers that are used to mask Compare and Write cycles. When a bit is set LOW in a selected mask register, the corresponding bit enters into comparison during a Compare cycle, or is written during a Write cycle. When a bit is set HIGH in a selected mask register, the corresponding bit does not enter into comparison during a Compare cycle, or remains unchanged after a Write cycle.

Address Register

The 32-bit Address register is used for indirect addressing of the Address Database. When random access to the Address Database is restricted to indirect addressing, the width of the control bus can be reduced to 9 bits if masking is used or 6 bits if it is not. Control states allow increment and decrement of the Address register as well as auto-increment and auto-decrement Read and Write cycles. Bits AR12-0 hold the address while bits AR31-13 are reserved and should be set LOW.

Configuration Register

The 32-bit Configuration register sets the persistent operating conditions of the MU9C RCP. Bits FR31-29 select which mask register is used for direct Write cycles to the Address database when the address is conveyed on the AC bus (/AV=LOW), a value of 000 in this field results in unmasked direct Write cycles. Bits FR27-26 select the mode of operation: Hardware Control mode or Software Control mode. Bit FR25 is used to identify the lowest-priority device in a vertically cascaded system. FR25 should be low for a stand-alone device (not cascaded). Bits FR3-0 hold the device Page address. All other bits are reserved and should be set LOW. See Table 3.

Status Register

The 32-bit Status register holds the results of the most recent control state that caused the PA:AA lines to change. It is intended for use in Software Control mode where results of an operation are read from the MU9C through the DQ31-0 lines. Bit SR30 holds the Match flag, /MF, which goes LOW when there is a match in the Address Database. Bit SR29 holds an internal version of the Multiple Match flag, /MM, which is LOW if there is a multiple match in the particular device; note that this is not a system-level multiple match indication. Bit SR28 holds the Full flag, /FF, which goes LOW when all the Address Database locations are set valid, and the /FI line is LOW. Bits SR25-24 indicate the type of result held in the Active Address field: Match address, Memory Access address, or Reset state. Bits SR19-16 hold the Page address, PA3-0, for the device. Bits SR12-0 hold the Active address, identical to that on the AA bus. All other bits are reserved and are set LOW. See Table 4.

Next Free Address Register

The 32-bit Next Free Address register holds the highest-priority address that has its Validity bit set empty (HIGH). System-level prioritization ensures that only the device with the highest-priority empty address in a vertically cascaded system will respond to a Read Next Free Address Register Control state. Bits NF19-16 hold the device Page address, PA3-0. Bits NF12-0 hold the next free address value. All other bits are reserved, and are set LOW. See Table 5.

Device Select Register

The 32-bit Device Select register is used for software selection of the MU9C RCP. A particular device is selected when the value in bits DS3-0 are the same as the Page Address value PA3-0 and the Device Select Enable bit, DS8, is set LOW. Setting DS8 HIGH prevents the Device Select register from enabling the MU9C RCP. All other bits are reserved and should be set LOW. See Table 6.

Instruction Register

In Software Control mode, control states are written to the 32-bit Instruction register instead of being fed to the MU9C RCP through the DSC and AC11-0 lines. Bits IR12-0 are equivalent to the DSC and AC11-0 lines and the control states they invoke are identical to those of the Hardware Control mode. The remaining bits are reserved and should be set LOW.

The Address Database

The Address Database is organized as 4096 or 8192 64-bit locations: location 0000H as the highest-priority location, and location 0FFFH as the lowest-priority location. Write cycles to the next free address start at location 0000H when the MU9C RCP is empty, and continue down to 0FFFH or 1FFFH when it becomes full.

Each 64-bit location in the Address Database array has one extra bit, the Validity bit, which is used to indicate whether the location is empty or has valid contents. When the Validity bit is HIGH, the location is empty and is not compared during Comparison cycles; when it is LOW the contents are valid and will be compared during a Comparison cycle. The Validity bits are set or reset during Write cycles through the /VB line. The Validity bit of a location is accessed on the /VB line during a Read cycle. The Validity bits can be set and reset through control states. The Validity bits also are used in the generation of the next free address value.

Address Database Access

Data is written to or read from the Address Database array either randomly by address, or associatively by comparison and next free address. Random addressing can be either direct with the address on the DSC and AC12-0 lines (/AV=LOW) or indirect with the address held in the Address register. Address Database access is controlled through the control states on the DSC and AC12-0 lines (/AV=HIGH) in Hardware Control mode, or through the Instruction register in Software Control mode.

Chip Select

There are two methods of selecting an MU9C RCP: through Hardware control inputs /CS1 and /CS2, and through software control through the Data Select register.

Chip Select Inputs

The Chip Select lines /CS1 and /CS2 enable an MU9C RCP to participate in a control cycle. If either /CS1 or /CS2 are LOW the device is selected. By connecting all the /CS1 lines together in a multi-device system, and decoding the lines to each individual device's /CS2 line, control states can operate locally within a single device or globally in all devices. Control states can be broadcast to all devices within the system by pulling the /CS1 lines LOW, for operations such as Write Comparand register; individual devices can be selected to respond to a control state such as Write at Address by pulling a single decoded /CS2 line LOW.

Device Select Register

One dedicated line is needed per device to do local selection of one device within a multi-device system. In cases where control lines are at a premium, the Device Select register can be used as the method of selection. If Device Select Register bit DS8 is LOW, only the device or devices whose Page Address value, held in Configuration Register bits FR3:0, match with the Device Select Register bits DS3-0 will be selected. Note that the match condition of the Device Select register is ORed with the state of the /CS1 and /CS2 lines. If DS8 is HIGH, the device remains unselected through the Device Select register.

The conditions of the Device Select register, the /CS1 and /CS2 lines are sampled at the time of the falling edge of /E. In a particular MU9C RCP within a system, that CAM will be selected under the following conditions:

$$(\text{/CS1=LOW}) \text{ OR } (\text{/CS2=LOW}) \\ \text{OR } ((\text{DS8} = \text{LOW}) \text{ AND } (\text{DS3-0} = \text{PA3-0}))$$

Therefore, the /CS1 lines of all devices are tied together for global cycles that broadcast control states to all devices within the system; then, for local cycles, an individual device is selected by loading all the Device Select Registers bit DS8 LOW and bits DS3-0 with the Page Address value of the device to be selected. On a subsequent cycle, /CS1 and /CS2 remain HIGH, and only the device whose Page Address value matches with its DS3-0 will respond. After an individual device has been selected, a global Write cycle to the Device Select register using /CS1 line is executed to select another device, or to disable the software chip select mechanism altogether.

Vertical Cascading

A system of any practical depth can be designed by vertically cascading MU9C RCPs. The scheme uses a daisy chain to provide system level prioritization as well as Match, Multiple Match, and Full flags. There are three daisy chains: Match, Multiple Match, and Full.

When a control state is broadcast that accesses the highest-priority matching location or Status register, the daisy chain ensures that only the device that responds is the one with the highest-priority match in the system. All other devices will have their DQ31-0 lines and PA:AA bus outputs held in high-impedance. Therefore, the Match Flag daisy chain controls access to the system resources for control states that are conditional on the results of the previous Compare cycle.

During a Comparison cycle, the Match and Multiple Match flags will not change until /E goes HIGH during that cycle. At this time, the daisy chain starts to resolve system-level prioritization. Once sufficient time has elapsed for the daisy chain to be resolved, the PA:AA bus can be enabled with /OE, and Status Register Read cycles will access only the highest-priority matching device. Note that the daisy chain resolves system-level prioritization combinatorially once initiated by /E going HIGH. Other cycles that do not affect the daisy chain or match results can take place in the MU9C RCP while the daisy chain is resolving, for example, WR CR, allowing some degree of pipelining. During a Write cycle, the Full flag will not change until /E goes HIGH during that cycle.

There is a small propagation delay per device in the daisy chain. Alternatively, vertical cascading can be done with external logic that provides prioritization and select lines back into each device. The MU9C RCP architecture supports external prioritization for cases where the daisy chain overhead proves unacceptable. Figure 4 shows a system in which a number of MU9C RCPs are vertically cascaded.

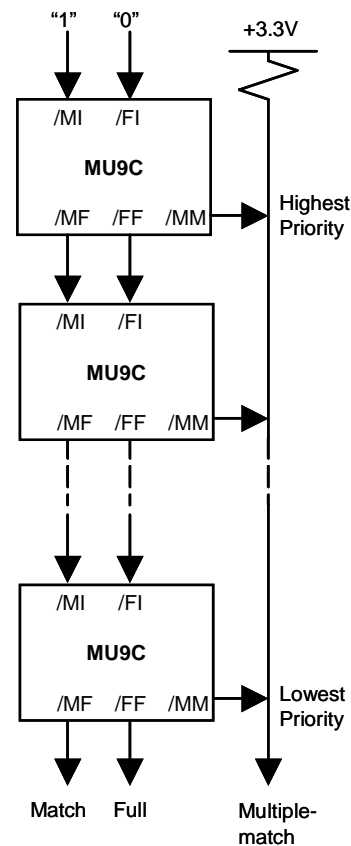

Figure 4: Vertically Cascading MU9C RCP's

Note: Only the lowest priority device's FR25 may be set to "0". All other devices should have their FR25 set to "1" (default value). Please refer to the MU9C RCP Cascading Application Note for more details.

Full Cascading

The Full flag is set LOW in a particular MU9C RCP if the /FI line is LOW, and that device is full. During a Write cycle, the Full flag will not change until /E goes HIGH during that cycle. When the /FI line is HIGH, one or more locations are free in the higher-priority devices; therefore, when the /FI line is HIGH, whether or not that particular device is full, its /FF output will remain HIGH. This method allows the Full Flag daisy chain to recognize non-contiguous empty locations throughout the entire MU9C RCP system.

The daisy chain gives System Full indication. When the device at the end of the chain has its /FF output LOW, the entire CAM system is full. The first device in the daisy chain has its /FI line tied LOW to ensure data can be written into the system.

The daisy chain also controls Write at Next Free Address cycles as well as Read Next Free Address cycles so that they work globally across the system, and not just locally in a specific device. Only the device in which the /FI line is LOW, and which is not full, will respond to the Write cycle. Therefore, deletions and insertions can be made in the memory, without the need to keep track of empty locations.

Match Cascading

The Match flag /MF will be LOW in a particular device within a vertically cascaded system when its /MI input is LOW, or when there is a match in that device. During a Comparison cycle, the Match flag will not change until /E goes HIGH during that cycle. When the /MI line is LOW, one or more locations in higher-priority devices have a match; when the /MI line is LOW, the /MF output will be forced LOW. This method allows the Match Flag daisy chain to respond to and prioritize matches throughout the entire MU9C RCP system.

The daisy chaining gives a System Match indication. When the device at the end of the daisy chain has its /MF output LOW, there is a match within the MU9C system. The first device in the daisy chain has its /MI input tied HIGH.

The daisy chain also controls access to the device by controlling the outputs during a Read Highest-Priority Match data, or Read Status register, onto the DQ31-0 lines. The device must be selected with either /CS1, or /CS2, or the Data Select register. After a Comparison or Read/Write at Highest-Priority Match Address cycle, only the device whose /MI line is HIGH, and which has a valid match, will drive data onto DQ31-0 or onto PA:AA bus; any device that has its /MI line set LOW will have its outputs in their high-impedance state, even if it has a valid

match. Therefore, Reads from and Writes to the Highest-Priority Matching address operate over the entire system; only the device in which the /MI line is HIGH and that has a match will respond to the cycle. This scheme automatically prioritizes a system of vertically cascaded devices, the highest up in the chain has the highest-priority. Note however, that cycles that do not access highest-priority match data or the Status register will operate without regard to the state of the Match daisy chain.

Multiple Match Flag Daisy Chain

The Multiple Match flag, /MM, is an open-drain output, and will be pulled LOW by a particular device when its /MI input is HIGH and there is more than one match within the device, or when the /MI input is LOW and there is one match within the device. During a Comparison cycle, the Multiple Match flag will not change until /E goes HIGH during that cycle. This wired-OR output provides system level indication of the multiple match condition within a vertically cascaded system of MU9C RCPs.

Match Flag Timing Overhead

There is a propagation delay for the match results to ripple down through the daisy chain. All the MU9C RCPs within the system execute a Comparison cycle in parallel, so the local results are available at the end of a Comparison cycle. The local Match flags do not change during a Comparison cycle until /E goes HIGH. The logical combination of the results then propagates down the daisy chain with a delay through each stage. The compare time in each device operating in parallel is added to the ripple delay through the daisy chain. Before reading the results of a comparison from the System Match flag, the daisy chain must be given time to settle to a valid state. If there are N devices vertically cascaded in a system, and the time to get a valid output on /MF for one device is $t(MF)$, and the propagation delay for the flag to ripple through one device from /MI valid to /MF valid is $t(PD)$, then the time $t(DC)$ for the daisy chain to develop a valid output condition is:

$$t(DC) = t(MF) + (N-1) * t(PD)$$

This period of time must elapse before the flagged results of the comparison are available, and before /OE is driven LOW or a Status Register Read cycle is performed.

There is a similar but shorter delay for the Full Flag daisy chain, but this only limits the rate at which back-to-back Write at Next Free Address cycles can be performed.

External Prioritization

For systems where the propagation delay associated with the Match Flag daisy chain is unacceptable, the MU9C RCP supports external prioritization. Using external prioritization, each /MF output is fed to a 1 of N prioritizing circuit whose outputs are fed back to the /CS and /OE inputs of the respective MU9C RCPs. Access to the Highest-Priority Match Memory location or Status register is accomplished by only enabling the /CS to the Highest-Priority Match device based on the status of the /MF flags in the system. Likewise, access to the Highest-Priority Match device's PA:AA bus match address result is accomplished by enabling only the /OE line to the Highest-Priority Match device.

Initialization

After power is applied to the MU9C RCP the /RESET line must be pulled LOW for at least 50 ns to ensure that the device establishes its correct initial operating conditions. There are control states to initialize the system-level operating conditions that can be run once the device or devices in the system have been reset after power has been applied.

Reset

The Reset condition occurs when the /RESET line is pulled LOW (Hardware reset,) or when the Reset Control state is executed (Software reset.) The conditions after a reset are shown in Table 2.

The Instruction register is enabled for Software Control mode. To activate Hardware control, the appropriate value should be written to the Configuration register in two cycles from the DQ31-0 lines.

For a Hardware reset, FR25, which defines the lowest priority device, is set HIGH. This means that either FR25 must be set LOW in the lowest-priority device, or a Memory access cycle or a Compare cycle that generates a match must be executed for there to be any response when reading the PA:AA bus or the Status register.

System Initialization

Once the MU9C RCP devices in the system have been reset, the system operating conditions must be set up. The MU9C RCP is reset to Software Control mode, so a value must be written to the Configuration register to set the persistent operating state of the device. This first write to the devices in the system must be through Software control. The following sequence writes a new value to the Configuration register under software control:

1. Write 006H to MU9C RCPs (/AV = HIGH, DQ13 = LOW).

The value 006H is the control state Write to Configuration register, WR FR, with no mask. /AV being HIGH indicates that this is the instruction to be written to the Instruction register, and DQ13 being LOW indicates that it is a Write cycle.

2. XXXXXXXXXH to MU9C RCPs (/AV=LOW). The value XXXXXXXXXH is written to the Configuration register, and if FR27-26=00 then the devices are set to operate in Hardware Control mode.

AV being LOW causes the control state to execute using the data present on the DQ31-0 lines.

If the devices in a vertically cascaded system are to be selected solely through the Device Select register, then the Page addresses must be set to unique values in each device. However, to set the Page address in each Configuration register in turn would require that each device already had a unique Page Address value. To overcome this dilemma, there are two special control states that allow the Page Address registers to be set individually in this circumstance. Once the general operating conditions have been established by broadcasting a configuration value to all the MU9C RCPs in the system, the Page Address values must be set to a unique value in each device. This is done through a sequence of WR PA control states, each executed with a unique value on the DQ31-0 lines. This control state writes the DS3-0 value into the Page Address field of the Configuration register of the highest-priority empty device, and then sets the Full flag of that device to indicate full (LOW). The next WR PA will therefore be directed to the next lower-priority device within the system. The sequence continues until all Page Address values have been written. The RST FF control state is then broadcast to all devices to set the Full flags back to Empty, and the system is then ready for normal operation.

JTAG

For detailed information on JTAG testing, refer to the IEEE Standard Test Access Port and Boundary-scan Architecture IEEE Std. 1149.1-1990 and 1149.1a-1993. The MU9C RCP Instruction register is 3 bits long, giving eight possible JTAG instructions. The least significant bit is clocked in first. The JTAG instructions are as follows:

JTAG Function	Instruction
EXTEST	000
RESERVED	001
RESERVED	010
CLAMP	011
IDCODE	100
INTEST	101
SAMPLE/PRELOAD	110
BYPASS	111

The MU9C4K64 IDCode is: X4000133H The MU9C8K64 IDCode is: XAC08133H (X is the four-bit revision code)

BSDL files are available; check the MUSIC Semiconductors website or contact MUSIC Technical Support.

CONTROL STATE OVERVIEW

Table 1: Control State Overview

AC Bus	/W = LOW	PA:AA	Scope	/W = HIGH	PA:AA	Scope
Register Read/Write (32-bit operations)						
xxx xxx 000 011	NOP	n/c	n/a	RD NFA	n/c	NFD
xxx nnn 000 100	WR AR {MRnnn}	n/c	AS	RD AR	n/c	S
xxx nnn 000 110	WR FR {MRnnn}	n/c	AS	RD FR	n/c	S
xxx nnn 001 000	WR DS {MRnnn}	n/c	AS	RD DS	n/c	S
xxx xxx 000 111	RESERVED	n/c	n/a	RD SR	n/c	HPD/S
xxx nnn 000 101	WRs CR {MRnnn}	n/c	AS	RDs CR	n/c	S
xxx nnn 001 001	WRs MRnnn	n/c	AS	RDs MRnnn	n/c	S
Memory Read/Write (32-bit operations)						
A(12:0)/A(11:0) [/AV = LOW]	WRs aaa	aaa	AS	RDs aaa	aaa	S
xxx nnn 000 000	WRs [AR] {MRnnn}	aaa	AS	RDs [AR]	aaa	S
xxx nnn 100 110	WRs [AR]+ {MRnnn}	aaa	AS	RDs [AR]+	aaa	S
xxx nnn 100 111	WRs [AR]- {MRnnn}	aaa	AS	RDs [AR]-	aaa	S
xxx nnn 000 010	WRs [HPM] {MRnnn}	HPMA	HPD	RDs [HPM]	HPMA	HPD
xxx nnn 000 001	WRs [NFA] {MRnnn}	NFA	NFD	RDs [HPM]; NEXT	HPMA	HPD
Data Move (64-bit operations)						
xxx nnn 001 100	MOV [AR],CR {MRnnn}	aaa	AS	MOV CR, [AR] {MRnnn}	aaa	AS
xxx nnn 001 101	MOV [NFA],CR {MRnnn}	NFA	NFD	RESERVED	n/c	AS
xxx nnn 001 110	MOV [HPM],CR {MRnnn}	HPMA	HPD	MOV CR, [HPM] {MRnnn}	HPMA	HPD
Comparison (64-bit operations)						
xxx nnn 011 000	CMP CR {MRnnn}	HPMA	AS	RESERVED	n/c	n/a
xxx nnn 011 001	CMPs DQ {MRnnn}	HPMA	AS	RESERVED	n/c	n/a
xxx nnn 011 010	CMPWs DQ {MRnnn}	HPMA	AS	RESERVED	n/c	n/a
xxx xxx 011 100	CMPT DQ	HPMA	HPD	RESERVED	n/c	n/a
xxx xxx 011 011	NEXT	HPMA	HPD	RESERVED	n/c	n/a
Validity Bit Control						
xxx xxx 100 000	SET V@[AR]	aaa	AS	RD V@[AR]	aaa	S
xxx xxx 100 001	RST V@[AR]	aaa	AS	RESERVED	n/c	n/a
xxx xxx 100 010	RST V@[HPM]	HPMA	HPS	RESERVED	n/c	n/a
xxx xxx 100 011	RST V@AML	HPMA	AS	RESERVED	n/c	n/a
Initialization						
xxx xxx 111 100	WR PA	n/c	NFD	RESERVED	n/c	n/a
xxx xxx 111 101	RST FF	n/c	AS	RESERVED	n/c	n/a
xxx xxx 111 111	RST	All 1's	AS	RESERVED	n/c	n/a
Address Register Control						
xxx xxx 100 100	INC AR	n/c	AS	RESERVED	n/c	n/a
xxx xxx 100 101	DEC AR	n/c	AS	RESERVED	n/c	n/a

Key: aaa = Random access address

All 1s = All PA:AA outputs HIGH

AS = All selected devices

HPD = Highest-Priority device

HPMA = Highest-Priority Match address

n/a = Not applicable

The "Scope" of a control state describes which devices respond in a multi-CAM system.

The "PA:AA" field describes what is output on the PA3-0:AA11-0 bus as a result of the control state.

/AV is HIGH unless otherwise noted.

DSC must be LOW if "s" is not indicated.

n/c = No change

NFA = Next Free address

NFD = Highest-Priority device with a Free location

s = Segment (L for DSC LOW, H for DSC HIGH)

S = Selected device

CONTROL STATE DESCRIPTIONS

REGISTER READ/WRITE

Control State: No Operation
Mnemonic: NOP Binary
Binary Op-Code: XXX XXX 000 011
/W: LOW /AV: HIGH PA:AA: n/c Scope: n/a

Description: No operation. The device performs no operation during the cycle. No existing states change. DSC must be LOW.

Control State: Read Next Free Address
Mnemonic: RD NFA
Binary Op-Code: XXX XXX 000 011
/W: HIGH /AV: HIGH PA:AA: n/c Scope: NFD

Description: Reads the value of the Next Free address on the DQ11-0/DQ12-0 bus. In a vertically cascaded system this will be in the device whose /FI=LOW and /FF=HIGH, and at the highest-priority location whose Validity bit is set HIGH. This value is the address of the location where a subsequent Write at Next Free Address cycle will be written. The Page address of the device value is output DQ19-16; DQ31-20 are LOW. DSC must be LOW.

Control State: Write Address Register
Mnemonic: WR AR{MRnnn}
Binary Op-Code: XXX nnn 000 100
/W: LOW /AV: HIGH PA:AA: n/c Scope: AS

Description: Writes data from the DQ31-0 bus to the Address register. The write is masked by the contents of Mask Register nnn. When nnn=000 no mask is used; when masking is selected, only bits in the addressed location that correspond to LOW values in the selected mask register are updated. DSC must be LOW.

Control State: Read Address Register
Mnemonic: RD AR
Binary Op-Code: XXX XXX 000 100
/W: HIGH /AV: HIGH PA:AA: n/c Scope: S

Description: Reads the contents of the Address register to the DQ31-0 bus. DSC must be LOW.

Control State: Write Configuration Register
Mnemonic: WR FR{MRnnn}
Binary Op-Code: XXX nnn 000 110
/W: LOW /AV: HIGH PA:AA: n/c Scope: AS

Description: Writes data from the DQ31-0 bus to the Configuration register. The write is masked by the contents of Mask Register nnn. When nnn=000 no mask is used; when masking is selected, only bits in the addressed location that correspond to LOW values in the selected mask register are updated. DSC must be LOW.

Control State: Read Configuration Register
Mnemonic: RD FR
Binary Op-Code: XXX XXX 000 110

/W: HIGH /AV: HIGH PA:AA: n/c Scope: S

Description: Reads the contents of the Configuration register to the DQ31-0 bus. DSC must be LOW.

Control State: Write Device Select Register
Mnemonic: WR DS{MRnnn}
Binary Op-Code: XXX nnn 001 000

/W: LOW /AV: HIGH PA:AA: n/c Scope: AS

Description: Writes data from the DQ31-0 bus to the Device Select register. The write is masked by the contents of Mask Register nnn. When nnn=000 no mask is used; when masking is selected, only bits in the addressed location that correspond to LOW values in the selected mask register are updated. DSC must be LOW.

Control State: Read Device Select Register
Mnemonic: RD DS
Binary Op-Code: XXX XXX 001 000

/W: HIGH AV: HIGH PA:AA: n/c Scope: S

Description: Reads the contents of the Device Select register to the DQ31-0 bus. DSC must be LOW.

Control State: Read Status Register
Mnemonic: RD SR
Binary Op-Code: XXX XXX 000 111

/W: HIGH /AV: HIGH PA:AA: n/c Scope: HPD/S

Description: Reads the contents of the Status register to the DQ31-0 bus. After a Comparison or Read/Write at Highest-Priority Matching Address cycle only the highest-priority device with a match responds to this control state; in the event of a mismatch, the lowest-priority device responds. After a random access Read or Write cycle into the Memory array, RD SR will take place in any selected device. DSC must be LOW.

Control State: Write Comparand Register
Mnemonic: WRs CR{MRnnn}
Binary Op-Code: XXX nnn 000 101

/W: LOW /AV: HIGH PA:AA: n/c Scope: AS

Description: Writes data from the DQ31-0 bus to bits 31-0 (DSC LOW) or 63-32 (DSC HIGH) of the Comparand register. The write is masked by bits 31-0 (DSC LOW) or 63-32 (DSC HIGH) of Mask Register nnn. When nnn=000 no mask is used; when masking is selected, only bits in the addressed location that correspond to LOW values in the selected mask register are updated.

Control State: Read Comparand Register
Mnemonic: RDs CR
Binary Op-Code: 0 XXX XXX 000 101
/W: HIGH /AV: HIGH PA:AA: n/c Scope: S
Description: Reads bits 31-0 (DSC LOW) or 63-32 (DSC HIGH) of the Comparand register to the DQ31-0 bus.

Control State: Write Mask Register
Mnemonic: WRs MRnnn
Binary Op-Code: XXX nnn 001 001
/W: LOW /AV: HIGH PA:AA: n/c Scope: AS
Description: Writes data from the DQ31-0 bus to bits 31-0 (DSC LOW) or 63-32 (DSC HIGH) of Mask register nnn. If nnn=000 then no data is written.

Control State: Read Mask Register
Mnemonic: RDs MRnnn
Binary Op-Code: XXX nnn 001 001
/W: HIGH /AV: HIGH PA:AA: n/c Scope: S
Description: Reads bits 31-0 (DSC LOW) or 63-32 (DSC HIGH) of Mask register nnn to the DQ31-0 bus. If nnn=000 then the output is undefined.

MEMORY READ/WRITE

Control State: Direct Write at Address
Mnemonic: WRs[aaa]
Binary Op-Code: aaa
/W: LOW /AV: LOW PA:AA: aaa Scope: AS
Description: Writes data from the DQ31-0 bus to bits 31-0 (DSC LOW) or 63-32 (DSC HIGH) of the location defined by the address value present on the AC bus. The write optionally can be masked by bits 31-0 (DSC LOW) or 63-32 (DSC HIGH) of the mask register selected through the Configuration register; when masking is selected, only bits in the addressed location that correspond to LOW values in the selected mask register are updated. The validity of the location is set by the state of the /VB input, /VB=LOW: Valid, /VB = HIGH: Empty. This control state provides direct random access memory writes. This control state, along with the Read cycle and HIGH segment equivalents are the only ones that use direct addressing. It is selected by the /AV line being LOW. All other control states have the /AV line HIGH whereby the AC bus carries a control code. This control state is not available in software mode.

Control State: Direct Read at Address
Mnemonic: RDs[aaa]
Binary Op-Code: aaa
/W: HIGH /AV: LOW PA:AA: aaa Scope: S
Description: Reads data from bits 31-0 (DSC LOW) or 63-32 (DSC HIGH) of the location defined by the address value present on the AC bus to the DQ31-0 bus. This control state provides direct random access memory reads. This control state, along with the Write cycle and HIGH segment equivalents are the only ones that use direct addressing. It is selected by the /AV line being LOW. All other control states have the /AV line HIGH whereby the AC bus carries a control code. During the Read cycle, the /VB line carries the Validity Bit value of the addressed location. This control state is not available in software mode.

Control State: Indirect Write at Address
Mnemonic: WRs[AR]{MRnnn}
Binary Op-Code: XXX nnn 000 000
/W: LOW /AV: HIGH PA:AA: aaa Scope: AS
Description: Writes data from the DQ31-0 bus to bits 31-0 (DSC LOW) or 63-32 (DSC HIGH) of the location defined by the contents of the Address register. The validity of the location is set by the state of the /VB input, /VB = LOW: Valid, /VB = HIGH: Empty. The write is masked by bits 31-0 (DSC LOW) or 63-32 (DSC HIGH) of the contents of Mask Register nnn. When nnn=000 no mask is used; when masking is selected, only bits in the addressed location that correspond to LOW values in the selected mask register are updated. This control state provides indirect random access memory writes.

Control State: Indirect Read at Address
Mnemonic: RDs[AR]
Binary Op-Code: XXX nnn 000 000
/W: HIGH /AV: HIGH PA:AA: aaa Scope: S
Description: Reads data from bits 31-0 (DSC LOW) or 63-32 (DSC HIGH) of the location defined by the contents of the Address register to the DQ31-0 bus. This control state provides indirect random access memory reads. During the Read cycle, the /VB line carries the Validity Bit value of the addressed location.

Control State: Indirect Write at Address;
Increment Address Register

Mnemonic: WRs[AR]+{MRnnn}

Binary Op-Code: XXX nnn 100 110

/W: LOW /AV: HIGH PA:AA: aaa Scope: AS

Description: Writes data from the DQ31-0 bus to bits 31-0 (DSC LOW) or 63-32 (DSC HIGH) of the location defined by the contents of the Address register. The validity of the location is set by the state of the /VB input, /VB = LOW: Valid, /VB = HIGH: Empty. The write is masked by bits 31-0 (DSC LOW) or 63-32 (DSC HIGH) of the contents of Mask Register nnn. When nnn=000 no mask is used; when masking is selected, only bits in the addressed location that correspond to LOW values in the selected mask register are updated. The contents of the Address register are incremented.

Control State: Indirect Read at Address;
Increment Address Register

Mnemonic: RDs[AR]+

Binary Op-Code: XXX XXX 100 110

/W: HIGH /AV: HIGH PA:AA: aaa Scope: S

Description: Reads data from bits 31-0 (DSC LOW) or 63-32 (DSC HIGH) of the location defined by the contents of the Address register to the DQ31-0 bus. This control state provides indirect random access memory reads. During the Read cycle, the /VB line carries the Validity Bit value of the addressed location. The contents of the Address register are incremented.

Control State: Indirect Write at Address;
Decrement Address Register

Mnemonic: WRs[AR]-{MRnnn}

Binary Op-Code: XXX nnn 100 111

/W: LOW /AV: HIGH PA:AA: aaa Scope: AS

Description: Writes data from bits 31-0 (DSC LOW) or 63-32 (DSC HIGH) of the DQ31-0 bus to the location defined by the contents of the Address register. The validity of the location is set by the state of the /VB input, /VB = LOW: Valid, /VB = HIGH: Empty. The write is masked by bits 31-0 (DSC LOW) or 63-32 (DSC HIGH) of the contents of Mask Register nnn. When nnn=000 no mask is used; when masking is selected, only bits in the addressed location that correspond to LOW values in the selected mask register are updated. The contents of the Address register are decremented.

Control State: Indirect Read at Address;
Decrement Address Register

Mnemonic: RDs[AR]-

Binary Op-Code: XXX XXX 100 111

/W: HIGH /AV: HIGH PA:AA: aaa Scope: S

Description: Reads data from bits 31-0 (DSC LOW) or 63-32 (DSC HIGH) of the location defined by the contents of the Address register to the DQ31-0 bus. This control state provides indirect random access memory reads. During the Read cycle, the /VB line carries the Validity Bit value of the addressed location. The contents of the Address register are decremented.

Control State: Write to Highest-Priority
Matching Location

Mnemonic: WRs[HPM]{MRnnn}

Binary Op-Code: XXX nnn 000 010

/W: LOW /AV: HIGH PA:AA: HPMA Scope: HPD

Description: Writes data from the DQ31-0 bus to bits 31-0 (DSC LOW) or 63-32 (DSC HIGH) of the highest-priority matching location in the Memory array. The validity of the location is set by the state of the /VB input, /VB=LOW: Valid, /VB=HIGH: Empty. The write is masked by bits 31-0 (DSC LOW) or 63-32 (DSC HIGH) of the contents of Mask Register nnn. When nnn=000 no mask is used; when masking is selected, only bits in the addressed location that correspond to LOW values in the selected mask register are updated.

Control State: Read Highest-Priority
Matching Location

Mnemonic: RDs[HPM]

Binary Op-Code: XXX XXX 000 010

/W: HIGH /AV: HIGH PA:AA: HPMA Scope: HPD

Description: Reads data from bits 31-0 (DSC LOW) or 63-32 (DSC HIGH) the location defined by the highest-priority matching location to the DQ31-0 bus. In the event that the previous Comparison cycle resulted in a mismatch, the DQ31-0 bus will remain in high-impedance.

Control State: Write at Next Free Address
Mnemonic: WRs[NFA]{MRnnn}
Binary Op-Code: XXX nnn 000 001
/W: LOW /AV: HIGH PA:AA: NFA Scope: NFD
Description: Writes data from the DQ31-0 bus to bits 31-0 (DSC LOW) or 63-32 (DSC HIGH) of the next free location in the Memory array. In a vertically cascaded system, the write will take place in the device whose /FI=LOW and /FF=HIGH, and at the highest-priority location whose Validity bit is set HIGH. The validity of the location is set by the state of the /VB input, /VB = LOW: Valid, /VB = HIGH: Empty. The write is masked by bits 31-0 (DSC LOW) or 63-32 (DSC HIGH) of the contents of Mask Register nnn. When nnn=000 no mask is used; when masking is selected, only bits in the addressed location that correspond to LOW values in the selected mask register are updated.

Control State: Read Highest-Priority Matching Location; Increment Match Address
Mnemonic: RDs[HPM]; NEXT
Binary Op-Code: XXX XXX 000 001
/W: HIGH /AV: HIGH PA:AA: HPMA Scope: HPD
Description: Reads data from bits 31-0 (DSC LOW) or 63-32 (DSC HIGH) of the location defined by the highest-priority matching location to the DQ31-0 bus. In the event that the previous Comparison cycle resulted in a mismatch, the DQ31-0 bus will remain in high-impedance. The Next Highest-Priority Matching location is selected and its address appears on the PA:AA bus lines.

DATA MOVE

Control State: Move Data from Comparand Register to Memory Indirect
Mnemonic: MOV [AR],CR{MRnnn}
Binary Op-Code: XXX nnn 001 100
/W: LOW /AV: HIGH PA:AA: aaa Scope: AS
Description: Moves data from the Comparand register to the memory address defined by the contents of the Address register. The validity of the location is set by the state of the /VB input, /VB = LOW: Valid, /VB = HIGH: Empty. The move is masked by the contents of Mask Register nnn. When nnn=000 no mask is used; when masking is selected, only bits in the addressed location that correspond to LOW values in the selected mask register are updated. DSC must be LOW.

Control State: Move Data from Memory to Comparand Register Indirect
Mnemonic: MOV CR,[AR]{MRnnn}
Binary Op-Code: XXX nnn 001 100
/W: HIGH /AV: HIGH PA:AA: aaa Scope: AS
Description: Moves data from the memory address defined by the contents of the Address register to the Comparand register. The move is masked by the contents of Mask Register nnn. When nnn=000 no mask is used; when masking is selected, only bits in the addressed location that correspond to LOW values in the selected mask register are updated. Note that the /VB line is not driven during this operation. DSC must be LOW.

Control State: Move Data from Comparand Register to Next Free Address
Mnemonic: MOV [NFA],CR{MRnnn}
Binary Op-Code: XXX nnn 001 101
/W: LOW /AV: HIGH PA:AA: NFA Scope: NFD
Description: Moves data from the Comparand Register to the Next Free address. In a vertically cascaded system, the write will take place in the device whose /FI=LOW and /FF=HIGH, and at the highest-priority location whose Validity bit is set HIGH. The validity of the location is set by the state of the /VB input, /VB = LOW: Valid, /VB = HIGH: Empty. The move is masked by the contents of Mask Register nnn. When nnn=000 no mask is used; when masking is selected, only bits in the addressed location that correspond to LOW values in the selected mask register are updated. DSC must be LOW.

Control State: Move Data from Comparand Register to Highest-Priority Matching Location
Mnemonic: MOV [HPM],CR{MRnnn}
Binary Op-Code: XXX nnn 001 110
/W: LOW /AV: HIGH PA:AA: HPMA Scope: HPD
Description: Moves data from the Comparand register to the Highest-Priority Matching address from the previous Comparison cycle. The validity of the location is set by the state of the /VB input, /VB = LOW: Valid, /VB = HIGH: Empty. The move is masked by the contents of Mask Register nnn. When nnn=000 no mask is used; when masking is selected, only bits in the addressed location that correspond to LOW values in the selected mask register are updated. DSC must be LOW.

Control State: Move Data from Highest-Priority Matching Location to Comparand Register

Mnemonic: MOV CR,[HPM]{MRnnn}

Binary Op-Code: XXX nnn 001 110

/W: HIGH /AV: HIGH PA:AA: HPMA Scope: HPD

Description: Moves data from the Highest-Priority Match address from the previous Comparison cycle to the Comparand register. The move is masked by the contents of Mask Register nnn. When nnn=000 no mask is used; when masking is selected, only bits in the addressed location that correspond to LOW values in the selected mask register are updated. Note that the /VB line is not driven during this operation. DSC must be LOW.

COMPARISON

Control State: Compare Comparand Register with Memory Array

Mnemonic: CMP CR,{MRnnn}

Binary Op-Code: XXX nnn 011 000

/W: LOW /AV: HIGH PA:AA: HPMA Scope: AS

Description: The Comparand register is compared with all locations in the Memory array that have their Validity bits set LOW. The comparison is masked by the contents of Mask Register nnn. When nnn=000 no mask is used; when masking is selected, only bits that correspond to LOW values in the selected mask register are compared. DSC must be LOW.

Control State: Compare Data Bus with Memory Array

Mnemonic: CMPs DQ,{MRnnn}

Binary Op-Code: XXX nnn 011 001

/W: LOW /AV: HIGH PA:AA: HPMA Scope: AS

Description: A comparand is formed such that bits 63-32 (DSC LOW) or 31-0 (DSC HIGH) of the Comparand register provide bits 63-32 (DSC LOW) or 31-0 (DSC HIGH) of the comparand, and bits 31-0 of the DQ bus provide bits 31-0 (DSC LOW) or 63-32 (DSC HIGH) of the comparand. This comparand is compared with all locations in the Memory array that have their Validity bits set LOW. The comparison is masked by the contents of Mask Register nnn. When nnn=000 no mask is used; when masking is selected, only bits that correspond to LOW values in the selected mask register are compared.

Control State: Compare Data Bus with Memory Array; Write Data Bus to Comparand Register

Mnemonic: CMPWs DQ,{MRnnn}

Binary Op-Code: XXX nnn 011 010

/W: LOW /AV: HIGH PA:AA: HPMA Scope: AS

Description: The data from the DQ31-0 bus is written to bits 31-0 (DSC LOW) or 63-32 (DSC HIGH) of the Comparand register. The data from the 64 bit Comparand register then is compared with all locations in the Memory array that have their Validity bits set LOW. The comparison is masked by the contents of Mask Register nnn. When nnn=000 no mask is used. Note that the selected mask register masks the comparison and not the write to Comparand register.

Control State: Compare Data Bus with Memory Array (Ternary Mode)

Mnemonic: CMPT DQ

Binary Op-Code: XXX nnn 011 100

/W: LOW /AV: HIGH PA:AA: HPMA Scope: AS

Description: The data from the DQ bus is used as both bits 31-0 of the comparand and a mask. The bit-wise complement of the data from the DQ bus is used as both bits 63-32 of the comparand and a mask. The resulting 64-bit comparand and mask are compared with all locations in the Memory array that have their Validity bits set LOW. The CMPT DQ instruction overwrites neither the comparand nor any mask register. DSC must be LOW.

Control State: Advance to Next Matching Location

Mnemonic: NEXT

Binary Op-Code: XXX nnn 011 011

/W: LOW /AV: HIGH PA:AA: HPMA Scope: HPD

Description: Advances the Match address to the next matching location when the previous Comparison cycle resulted in a multiple match. The /MF flag will go HIGH when all matches have been exhausted, therefore the scheme operates in vertically cascaded systems through the priority daisy chain. DSC must be LOW.

VALIDITY BIT CONTROL**Control State:** Set Valid Indirect**Mnemonic:** SET V@[AR]**Binary Op-Code:** XXX XXX 100 000**/W:** LOW **/AV:** HIGH **PA:AA:** aaa **Scope:** AS

Description: Set the Validity bit LOW at the location pointed to by the contents of the Address register. The location is set valid and will enter into comparisons during a Comparison cycle, and will not be written to during a Write at Next Free Address cycle. DSC must be LOW.

Control State: Read Validity Indirect**Mnemonic:** RD V@[AR]**Binary Op-Code:** XXX XXX 100 000**/W:** HIGH **/AV:** HIGH **PA:AA:** aaa **Scope:** S

Description: Reads the Validity bit at the location addressed by the contents of the Address register onto DQ0. When the validity value is LOW, the location is valid; when the validity value is HIGH, the location is empty. DQ31-1 will read as logical 0s. DSC must be LOW.

Control State: Set Empty Indirect**Mnemonic:** RST V@[AR]**Binary Op-Code:** XXX XXX 100 001**/W:** LOW **/AV:** HIGH **PA:AA:** aaa **Scope:** AS

Description: Set the Validity bit HIGH at the location pointed to by the contents of the Address register. The location is set empty and will not enter into comparisons during a Comparison cycle, and may be written to during a Write at Next Free Address cycle. DSC must be LOW.

Control State: Set Empty at Highest-Priority Matching Location**Mnemonic:** RST V@[HPM]**Binary Op-Code:** XXX XXX 100 010**/W:** LOW **/AV:** HIGH **PA:AA:** HPMA **Scope:** HPD

Description: Set the Validity bit HIGH at the highest-priority matching location from the previous Comparison cycle. The location is set empty and will not enter into comparisons during a Comparison cycle, and may be written to during a Write at Next Free Address cycle. DSC must be LOW.

Control State: Set Empty at All Matching Locations**Mnemonic:** RST V@[AML]**Binary Op-Code:** XXX XXX 100 011**/W:** LOW **/AV:** HIGH **PA:AA:** HPMA **Scope:** AS

Description: Set the Validity bit HIGH at all matching locations from the previous Comparison cycle. The locations are set empty and will not enter into comparisons during a Comparison cycle, and will be written to during a Write at Next Free Address cycle. DSC must be LOW.

INITIALIZATION**Control State:** Write Page Address to Highest-Priority Empty Device; Set Full**Mnemonic:** WR PA**Binary Op-Code:** XXX XXX 111 100**/W:** LOW **/AV:** HIGH **PA:AA:** n/c **Scope:** NFD

Description: Writes DQ3-0 to the Page Address field of the Configuration register, and sets the /FF LOW. This control state is intended for sequential loading of Page addresses in vertically cascaded systems that do not have explicit lines controlling the /CS inputs to the individual devices. DSC must be LOW.

Control State: Reset Full Flag**Mnemonic:** RST FF**Binary Op-Code:** XXX XXX 111 101**/W:** LOW **/AV:** HIGH **PA:AA:** n/c **Scope:** AS

Description: Resets /FF HIGH. Used after sequentially loading the PA fields with previous control state to set the system back to empty. DSC must be LOW.

Control State: Reset**Mnemonic:** RST**Binary Op-Code:** XXX XXX 111 111**/W:** LOW **/AV:** HIGH **PA:AA:** All 1s **Scope:** AS

Description: Resets the MU9C RCP. DSC must be LOW.

ADDRESS REGISTER CONTROL**Control State:** Increment Address Register**Mnemonic:** INC AR**Binary Op-Code:** XXX XXX 100 100**/W:** LOW **/AV:** HIGH **PA:AA:** n/c **Scope:** AS

Description: Increments the value held in the Address register. Used for automatic sequencing through addresses in the Memory array. DSC must be LOW.

Control State: Decrement Address Register**Mnemonic:** DEC AR**Binary Op-Code:** XXX XXX 100 101**/W:** LOW **/AV:** HIGH **PA:AA:** n/c **Scope:** AS

Description: Decrements the value held in the Address register. Used for automatic sequencing through addresses in the Memory array. DSC must be LOW.

Control State: Undefined Operations**Mnemonic:** RESERVED

Description: Binary Op-Codes that are not documented are reserved control states. The results of these control states are undefined.

Table 2: Reset Conditions

Resource	Hardware Reset	Software Reset
Memory Array	All locations set Empty	All locations set Empty
Comparand Register	00000000H	00000000H
Mask Registers 1-7	00000000H	00000000H
Address Register	00000000H	00000000H
Instruction Register	00000000H	No Change
Next Free Address Register	00000000H	00000000H
Device Select Register DS31-4 Reserved DS8 SELEN DS7-4 Reserved DS3-0 Device Select	000000H 1 = Disabled 0000 1111	000000H 1 = Disabled 0000 No Change
Status Register SR31 Reserved SR30-28 Flags SR27-26 Reserved SR25-24 Active Address Type SR23-20 Reserved SR19-16 Page Address SR15-13 Reserved SR12-0 Active Address	0 111 = No Match, Not Full 00 11 = Reset State 0000 1111 000 111111111111 (SR12 is set to 0 on MU9C4K)	0 1111 00 11 = Reset State 0000 1111 000 111111111111 (SR12 is set to 0 on MU9C4K)
Configuration Register FR31-29 Direct Write Mask Source FR28 Reserved FR27-26 Control Mode FR25 LPC FR24-4 Reserved FR3-0 Page Address	000 = No Mask 0 11 = Software Control Mode 1 = Not Low Priority CAM 000000H 1111	No Change 0 No Change No Change No Change No Change

Table 3: Configuration Register Bit Assignments

Bit(s)	Names	Description
31:29	Direct Write Mask Source	000 = No Mask 001 = Mask Register 1 010 = Mask Register 2 011 = Mask Register 3 100 = Mask Register 4 101 = Mask Register 5 110 = Mask Register 6 111 = Mask Register 7
28	Reserved	Set to 0
27:26	Control Mode	00 = Hardware Control Mode 01 = Reserved 10 = Reserved 11 = Software Control Mode. (If /AV = 1, access Status Register.)
25	LPC	0 = Low priority CAM 1 = Not low priority CAM
24:4	Reserved	Set to 0
3:0	Page Address PA3-0	Page Address value

Table 4: Status Register Bit Assignments

Bit(s)	Names	Description
31	Reserved	Set to 0
30	/MF	0 = Match in CAM 1 = No match in CAM
29	/MM	0 = Multiple match in CAM 1 = No multiple match in CAM
28	/FF	0 = Full 1 = Not full
27:26	Reserved	Set to 0
25:24	Active Address Type	00 = Match address 01 = Memory access 10 = Reserved 11 = Reset state
23:20	Reserved	Set to 0
19:16	Page Address PA3-0	Page Address
15:13	Reserved	Set to 0
12:0	Active Address AA12-0	Active Address (AA12 is set to 0 on MU9C4K)

Table 5: Next Free Register Bit Assignments

Bit(s)	Names	Description
31:20	Reserved	Set to 0
19:16	Page Address PA3-0	Page Address
15:13	Reserved	Set to 0
12:0	Active Address NF12-0	Active Address (NF12 is set to 0 on MU9C4K)

Table 6: Device Select Register Bit Assignments

Bit(s)	Names	Description
31:9	Reserved	Set to 0
8	SELEN	0 = Enable Select 1 = Disable Select
7:4	Reserved	Set to 0
3:0	Device Select DS3-0	Device Select when PA3-0 = DS3-0 and SELEN = 0

ELECTRICAL

Absolute Maximum Ratings

Supply Voltage:	-0.5 to 4.6 Volts
Voltage on all other pins	-0.5 to VDD +0.5 Volts (-2 Volts for 10 ns, measured at the 50% point)
Temperature under bias	-40° C to 85° C
Storage Temperature	-55° C to 125° C
DC Output Current	20 mA (per output, one at a time, one second duration)

Stresses exceeding those listed under Absolute Maximum Ratings may induce failure. Exposure to absolute maximum ratings for extended periods may reduce reliability. Functionality at or above these conditions is not implied.

All voltages referenced to VSS.

Operating Conditions

Voltages referenced to GND at the device pin.

Symbol	Parameter	Min.	Typical	Max.	Units	Notes
V _{CC}	Operating supply voltage	3.0	3.3	3.6	Volts	
V _{IH}	Input voltage logic 1	2.0		V _{CC} + 0.3	Volts	
V _{IL}	Input voltage logic 0	-0.3		0.8	Volts	1, 2
T _A	Ambient operating temperature	Commercial	0	70	°C	Still air
		Industrial	-40	85	°C	

Notes:

- 1.0 Volts for a duration of 10 ns measured at the 50% amplitude points for Input-only lines (see Figure 6 on page 27).
- Common I/O lines are clamped, so that signal transients can not fall below -0.5 Volts.

Electrical Characteristics

Symbol	Parameter		Min.	Typical	Max.	Units	Notes
I _{DD}	Average Power Supply Current	MU9C4K64		200	350	mA	
		MU9C8K64	-35	470	650	mA	
			-40	410	600	mA	
			-50	320	450	mA	
			-70	225	350	mA	
			-90	180	275	mA	
I _{DD(SB)}	Stand-by power supply current		2	5	mA	/E = HIGH	
V _{OH}	Output voltage logic 1	2.4			Volts	I _{OH} = -2.0 mA	
V _{OL}	Output voltage logic 0			0.4	Volts	I _{OL} = 4.0 mA	
I _{Iz}	Input leakage current	Others	-2		+2	uA	V _{SS} ≤ V _{IN} ≤ V _{DD}
		Internal Pull-Ups	6	9	15	Kohms	V _{IN} = V _{CC} ; 11
I _{OZ}	Output leakage current		-10		10	mA	V _{SS} ≤ V _{OUT} ≤ V _{DD} DQ _N = High-Z

Capacitance

Symbol	Parameter	Max.	Units	Notes
C _{IN}	Input capacitance	6	pF	f = 1 MHz, V _{IN} = 0V
C _{OUT}	Output capacitance	7	pF	f = 1 MHz, V _{OUT} = 0V

AC Test Conditions

Input Signal Transitions	0.0 Volts to 3.0 Volts
Input Signal Rise Time	< 3 ns
Input Signal Fall Time	< 3 ns
Input Timing Reference Level	1.5 Volts
Output Timing Reference Level	1.5 Volts

Switching Test Figures

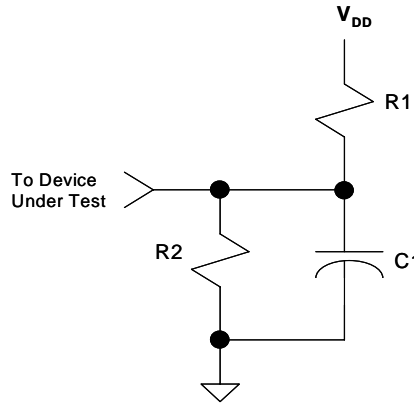

Figure 5: AC Test Load

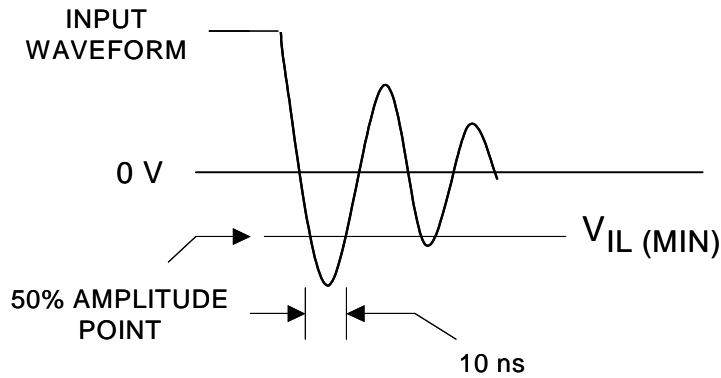

Figure 6: Input Signal Waveform

Table 7: Switching Test Figures Components Value

Parameter		MU9C4K64	MU9C8K64	Units
VCC		3.3	3.3	Volts
R1		635	635	Ohms
R2		702	702	Ohms
C1 (includes jig)	Test Load A	30	30	pF
	Test Load B	5	5	pF

SWITCHING CHARACTERISTICS

No.	Symbol	Parameter	-35		-40		-50		-70		-90		Notes	
			Min	Max	Min	Max	Min	Max	Min	Max	Min	Max		
1a	tELEL	Chip Enable Cycle Time (Other Cycles)	40		40		50		50		50		3	
1b	tELEL	Chip Enable Cycle Time (Compare Cycles)	35		40		50		70		90		4	
2a	tELEH	Chip Enable LOW Pulse Width (Other Cycles)	30		30		40		40		40		3	
2b	tELEH	Chip Enable LOW Pulse Width (Compare Cycles)	25		30		40		60		75		4	
3	tEHEL	Chip Enable HIGH Pulse Width	9		10		10		10		10			
4	tCVEL	Control Input to Chip Enable LOW Setup Time	5		5		5		5		8		5	
5	tELCX	Control Input to Chip Enable LOW HoldTime	4		4		4		4		4		5	
6	tELQX	Chip Enable LOW to Outputs Active	5		5		5		5		5		6	
7	tELQV	Chip Enable LOW to Outputs Valid	Register		30		35		40		40		40	6
			Memory		35		40		50		50		70	7
8	tEHQZ	Chip Enable HIGH to Outputs High-Z	2	10	2	10	2	10	2	10	2	10	6	
9	tDVEL	Data to Chip Enable LOW Setup Time	4		4		4		4		4			
10	tELDX	Data from Chip Enable LOW Hold Time	Commercial	4		4		4		4		4		
			Industrial	n/a		5		5		5		5		
11	tFIVEL	Full In Valid to Chip Enable LOW Setup Time	0		0		0		0		0			
12	tFIVFFV	Full In Valid to Full Flag Valid		5		6		8		8		9		
13	tEHFFV	Chip Enable HIGH to Full Flag Valid		15		15		16		16		16		
14	tEHQX	Chip Enable HIGH to Output Change	2		2		2		2		2			
15	tEHQV	Chip Enable HIGH to Output Valid		15		18		22		22		25		
16	tMIVEL	Match In Valid to Chip Enable Low Setup Time	4		6		8		8		10			
17	tEHMX	Chip Enable HIGH to Match Flag Change	2		2		2		2		2			
18	tEHMV	Chip Enable HIGH to Match Flag Valid	/MF		12		14		15		17		20	
			/MM		15		15		15		17		20	
19	tELMV	Chip Enable LOW to Match Flag Valid		42		50		60		n/a		n/a		
20	tMIVMV	Match In Valid to Match Flag Valid	/MF		5		6		8		8		9	
			/MM		7		7		8		8		9	
21	tOEHQZ	Output Enable HIGH to Outputs High-Z	2	10	2	10	2	10	2	10	2	10		
22	tOELQV	Output Enable HIGH to Match Address Outputs Valid		8		10		12		12		14		
23	tMIVOEL	Match In Valid to Output Enable LOW	3		3		3		3		3			
24	tFIVOEL	Full In Valid to Output Enable LOW	3		3		3		3		3			
25	tEHRSTL	Chip Enable HIGH to Reset LOW	10		15		20		20		20			
26	tRSTLRSTH	Reset Pulse Width	25		30		50		50		50		8	
27	tRSTHEL	Reset HIGH to Chip Enable LOW	10		15		20		20		20			
28	tTIVTCLKH	Test Input Valid to TCLK HIGH Setup Time	20		20		20		20		20		9	
29	tTCLKHTIX	TCLK HIGH to Test Input Hold Time	20		20		20		20		20		9	
30	tTCLKLTDOX	TCLK LOW to TDI Change	2	10	2	10	2	10	2	10	2	10		
31	tTCLKLTDOV	TCLK LOW to TDO Valid		20		20		20		20		20		
32	tTCLKLTDOZ	TCLK LOW to TDO High-Z	20		20		20		20		20			

Notes:

1. -1.0 Volts for a duration of 10 ns measured at the 50% amplitude points for Input-only lines (see Figure 6 on page 27).
2. Common I/O lines are clamped, so that signal transients can not fall below -0.5 Volts.
3. Applies to all cycle types except Compare cycles and Memory Read cycles (memory to DQ).
4. Applies to Compare cycle (including NEXT).
5. Control signals are /CS1, /CS2, /W, /AV, DSC, and the AC bus.
6. With load specified in Figure 5 on page 27, Test Load A from Table 7.
7. With load specified in Figure 5 on page 27, Test Load B from Table 7.
8. /E should be HIGH during /RESET active to ensure proper device defaults.
9. Test inputs are TDI and TMS signals.
10. With output and I/O pins unloaded.
11. Pins with internal pull-ups are /RESET, TCLK, TMS, TDI, and /TRST.

TIMING DIAGRAMS

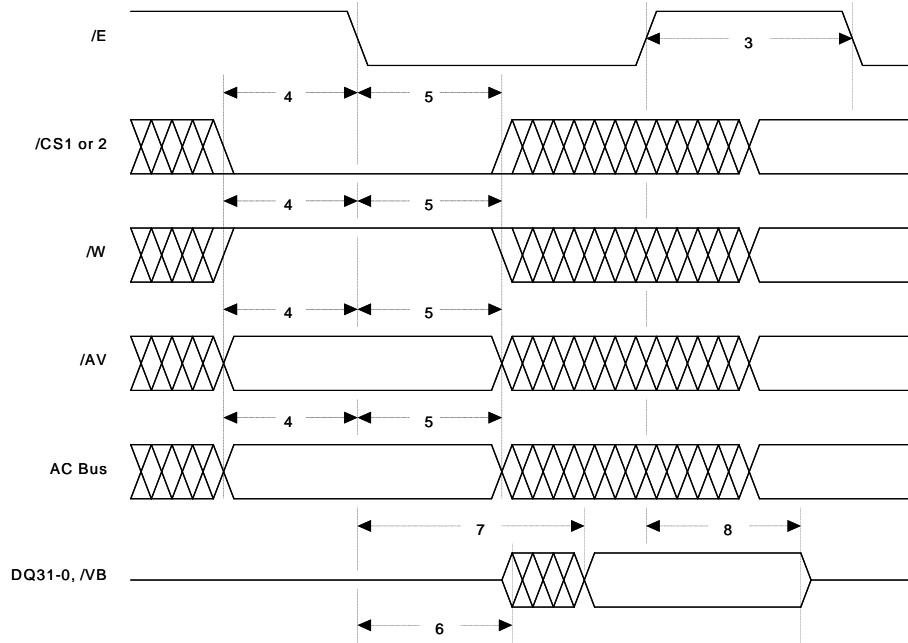

Figure 7: Read Cycle

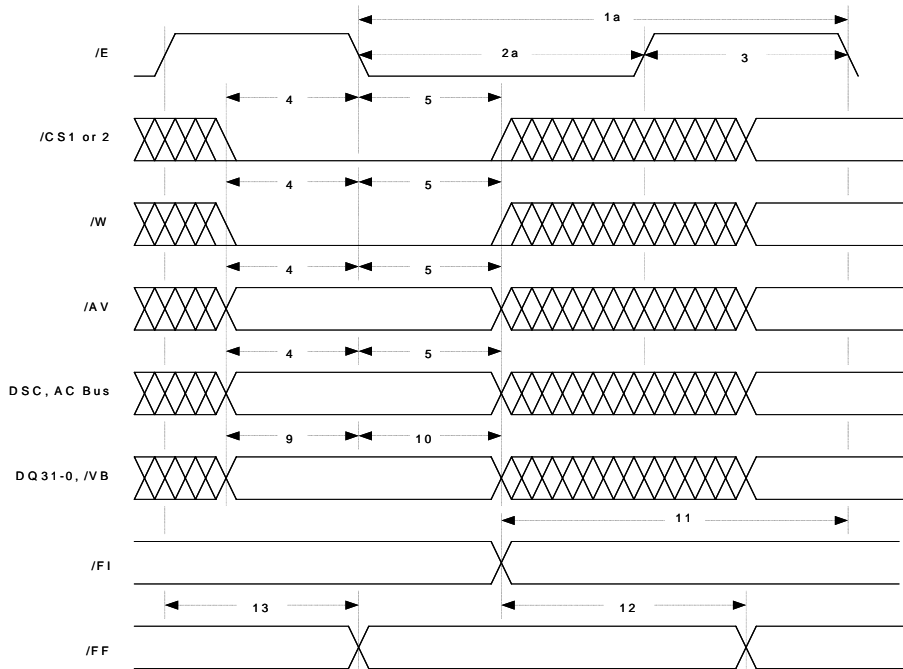

Figure 8: Write Cycle

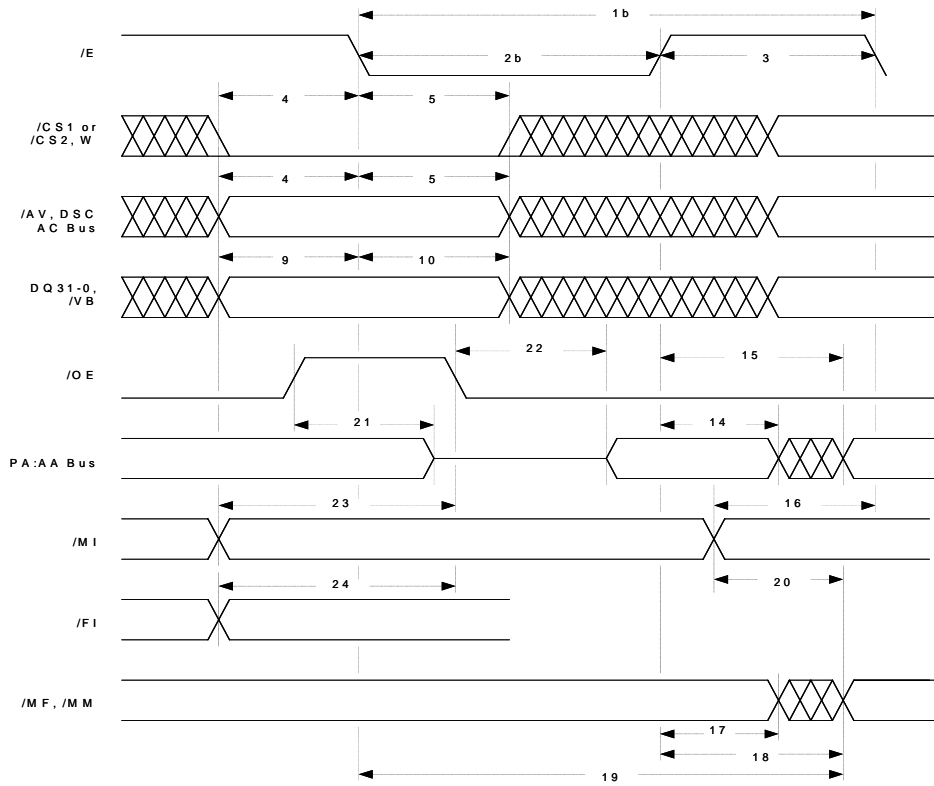

Figure 9: Compare Cycle

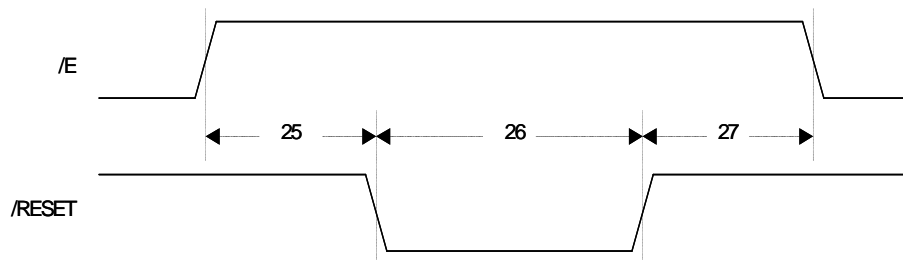

Figure 10: Reset Cycle

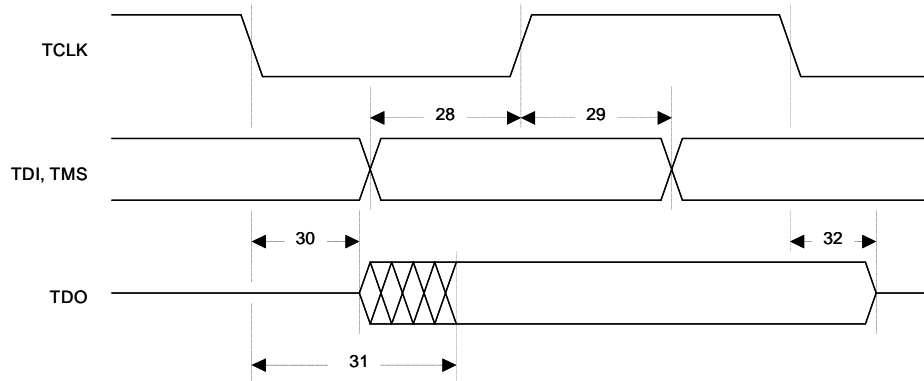
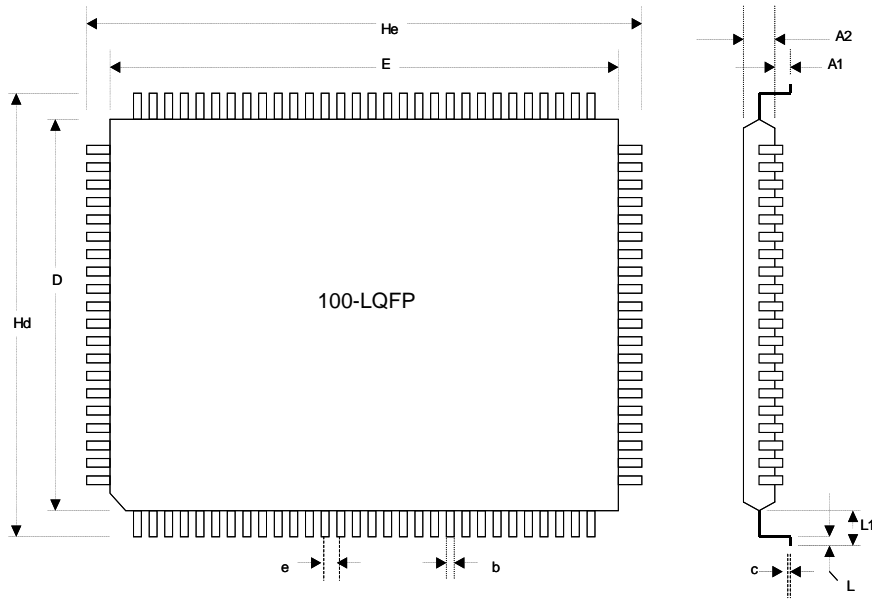
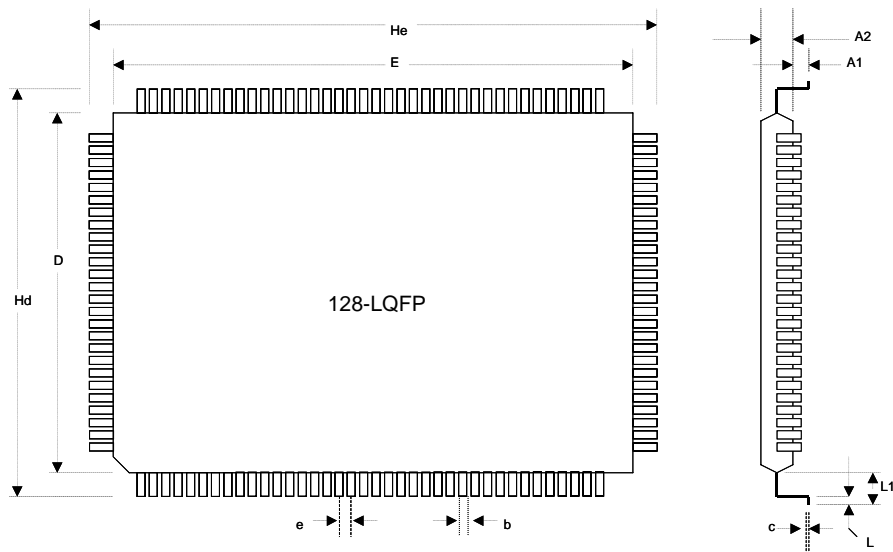

Figure 11: JTAG Test Cycle

PACKAGES



100-pin LQFP	Dim. A1	Dim. A2	Dim. b	Dim. c	Dim. D	Dim. E	Dim. e	Dim. Hd	Dim. He	Dim. L1	Dim L
Min.	0.05	1.35	0.22	0.09	13.90	19.90	0.65 nom	15.90	21.90	1.0 nom	0.45
Max.	0.15	1.45	0.38	0.20	14.10	20.10		16.10	22.10		0.75



128-pin LQFP	Dim. A1	Dim. A2	Dim. b	Dim. c	Dim. D	Dim. E	Dim. e	Dim. Hd	Dim. He	Dim. L1	Dim L
Min.	0.05	1.35	0.17	0.09	13.90	19.90	0.50 nom	15.90	21.90	1.0 nom	0.45
Max.	0.15	1.45	0.27	0.20	14.10	20.10		16.10	22.10		0.75

ORDERING INFORMATION

Part Number	Organization	Cycle Time	Package	Temperature
MU9C4K64-50TDC MU9C4K64-70TDC MU9C4K64-90TDC	4096 x 64 4096 x 64 4096 x 64	50 ns 70 ns 90 ns	100-PIN LQFP	0–70° C
MU9C4K64-50TEC *	4096 x 64	50 ns	128-PIN LQFP	0–70° C
MU9C4K64-70TDI MU9C4K64-90TDI	4096 x 64 4096 x 64	70 ns 90 ns	100-PIN LQFP	-40–85° C
MU9C8K64-35TDC MU9C8K64-50TDC MU9C8K64-70TDC MU9C8K64-90TDC	8192 x 64 8192 x 64 8192 x 64 8192 x 64	35 ns 50 ns 70 ns 90 ns	100-PIN LQFP	0–70° C
MU9C8K64-35TEC * MU9C8K64-50TEC *	8192 x 64 8192 x 64	35 ns 50 ns	128-PIN LQFP	0–70° C
MU9C8K64-50TDI MU9C8K64-70TDI MU9C8K64-90TDI	8192 x 64 8192 x 64 8192 x 64	50 ns 70 ns 90 ns	100-PIN LQFP	-40–85° C
MU9C8K64-50TEI *	8192 x 64	50 ns	128-PIN LQFP	-40–85° C

*Note: * TEC 128-pin LQFP package is recommended for new designs.*

ORDERING INFORMATION LEAD-FREE PRODUCTS

For ordering Lead-Free products please add an "F" directly after the product name (in front of the speed grade).

Example: MU9C8K64F-50TEC

MUSIC Semiconductors' agent or distributor:	MUSIC Semiconductors reserves the right to make changes to its products and specifications at any time in order to improve on performance, manufacturability or reliability. Information furnished by MUSIC is believed to be accurate, but no responsibility is assumed by MUSIC Semiconductors for the use of said information, nor for any infringements of patents or of other third-party rights which may result from said use. No license is granted by implication or otherwise under any patent or patent rights of any MUSIC company. © Copyright 2000 and 2002, MUSIC Semiconductors
--	--

USA Headquarters
MUSIC Semiconductors
Orlando, FL

Tel: 407 850-1035
Fax: 407 850-1063

North American Sales
MUSIC Semiconductors

Tel: 908 619-6818
Fax: 828 278-0218

Asian Headquarters
MUSIC Semiconductors
110 Excellence Ave., SEPZ 1
Carmelray Industrial Park
Canlubang, Laguna
Philippines 4028
Tel: +63 49 549-1480
Fax: +63 49 549-1024

European Headquarters
MUSIC Semiconductors
Raadhuisplein 10
6436 BW Amstenrade
The Netherlands
Tel: +31 43 455-2675
Fax: +31 43 455-1573

<http://www.musicsemi.com>



email: info@musicsemi.com