

Distinctive Characteristics

Available in flat frame and bracketed PC mounting types.

Over-center actuator block and plunger design gives crisp actuation with clear indication of circuit status; this design also diminishes sparking and increases operating life.

Guide interlocked with actuator block prevents window locking and maintains correct plunger alignment to assure contact stability.

Antijamming design protects contacts from damage due to excessive downward force on the actuator.

High internal barriers between poles and insulating sheet between case and actuator block give added protection to contacts.

Specially composed silver alloy contacts for power applications or gold contacts for logic level applications give high contact reliability.

Prominent external insulating barriers increase insulation resistance and dielectric strength.

Epoxy sealed terminals prevent entry of flux, solvents, and other contaminants.

Clinching of frame to case well above base and terminals provides 1,500V dielectric strength.

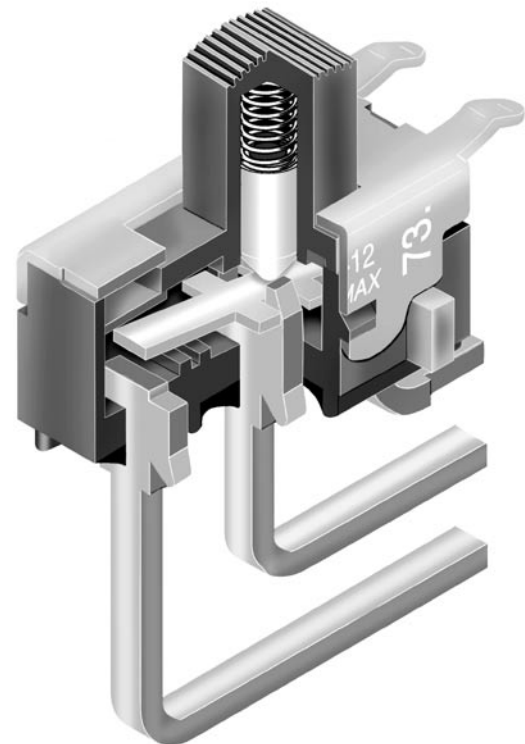

Actual Size

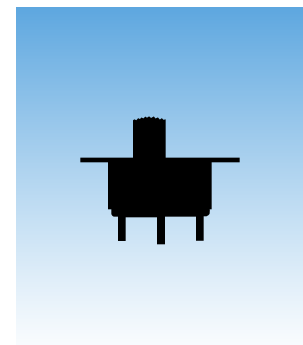

General Specifications

Electrical Capacity (Resistive Load)

Power Level (code W): 6A @ 125V AC or 3A @ 250V AC
Logic Level (code G): 0.4VA maximum @ 28V AC/DC maximum
 (Applicable Range 0.1mA ~ 0.1A @ 20mV ~ 28V)

Logic/Power Level (code A): Combines W & G ratings
 Note: Find additional explanation of dual rating & operating range in Supplement section.

Other Ratings

Contact Resistance: 10 milliohms maximum for silver; 20 milliohms maximum for gold
Insulation Resistance: 1,000 megohms minimum @ 500V DC
Dielectric Strength: 1,000V AC minimum between contacts for 1 minute minimum;
 1,500V AC minimum between contacts & case for 1 minute minimum
Mechanical Life: 100,000 operations minimum
Electrical Life: 25,000 operations minimum for silver; 50,000 operations minimum for gold
Contact Timing: Nonshorting (break-before-make)
Total Travel: On-None-On circuit .087" (2.2mm); all other circuits .138" (3.5mm)

Materials & Finishes

Actuator: Glass fiber reinforced polyester
Frame: Stainless steel for panel & PCB mount; phosphor bronze with tin plating for bracket mount
Dust Cover: Phosphor bronze with nickel plating
Case: Glass fiber reinforced diallyl phthalate resin (UL94V-0)
Movable Contacts: Silver alloy (code W); copper with gold plating (code G);
 or silver alloy with gold plating (code A)
Stationary Contacts: Silver capped copper with silver plating (code W); copper with gold plating (code G);
 or silver alloy with gold plating (code A)
Terminals: Copper or brass with silver or gold plating

Environmental Data

Operating Temp Range: -30°C through +85°C (-22°F through +185°F)
Humidity: 90 ~ 95% humidity for 96 hours @ 40°C (104°F)
Vibration: 10 ~ 55Hz with peak-to-peak amplitude of 1.5mm traversing the frequency range & returning in 1 minute; 3 right angled directions for 2 hours
Shock: 50G (490m/s²) acceleration (tested in 6 right angled directions, with 5 shocks in each direction)

Processing

Soldering: Wave Soldering recommended (PC Mount). See Profile A in Supplement section.
 Manual Soldering: See Profile A in Supplement section.
Cleaning: These devices are not process sealed. Hand clean locally using alcohol based solution.

Standards & Certifications

Flammability Standards: UL94V-0 rated case



UL Recognized: All Single & Double Pole Double Throw models recognized at 6A @ 125V AC & 3A @ 250V AC;
 UL File No. WOYR2.E44145; add "/U" to end of part number to order UL mark on switch.



C-UL Recognized: All Single & Double Pole Double Throw models recognized at 6A @ 125V AC & 3A @ 250V AC;
 UL File No. WOYR8.E44145; add "/C-UL" to end of part number to order C-UL mark on switch.



CSA Certified: All Double Throw & 3 Throw models certified at 6A @ 125V AC, 3A @ 250V AC, &
 0.4VA maximum @ 28V DC; CSA File No. 023535-0-000; add "/C" to end of part number
 to order CSA mark on switch.

TYPICAL SWITCH ORDERING EXAMPLE

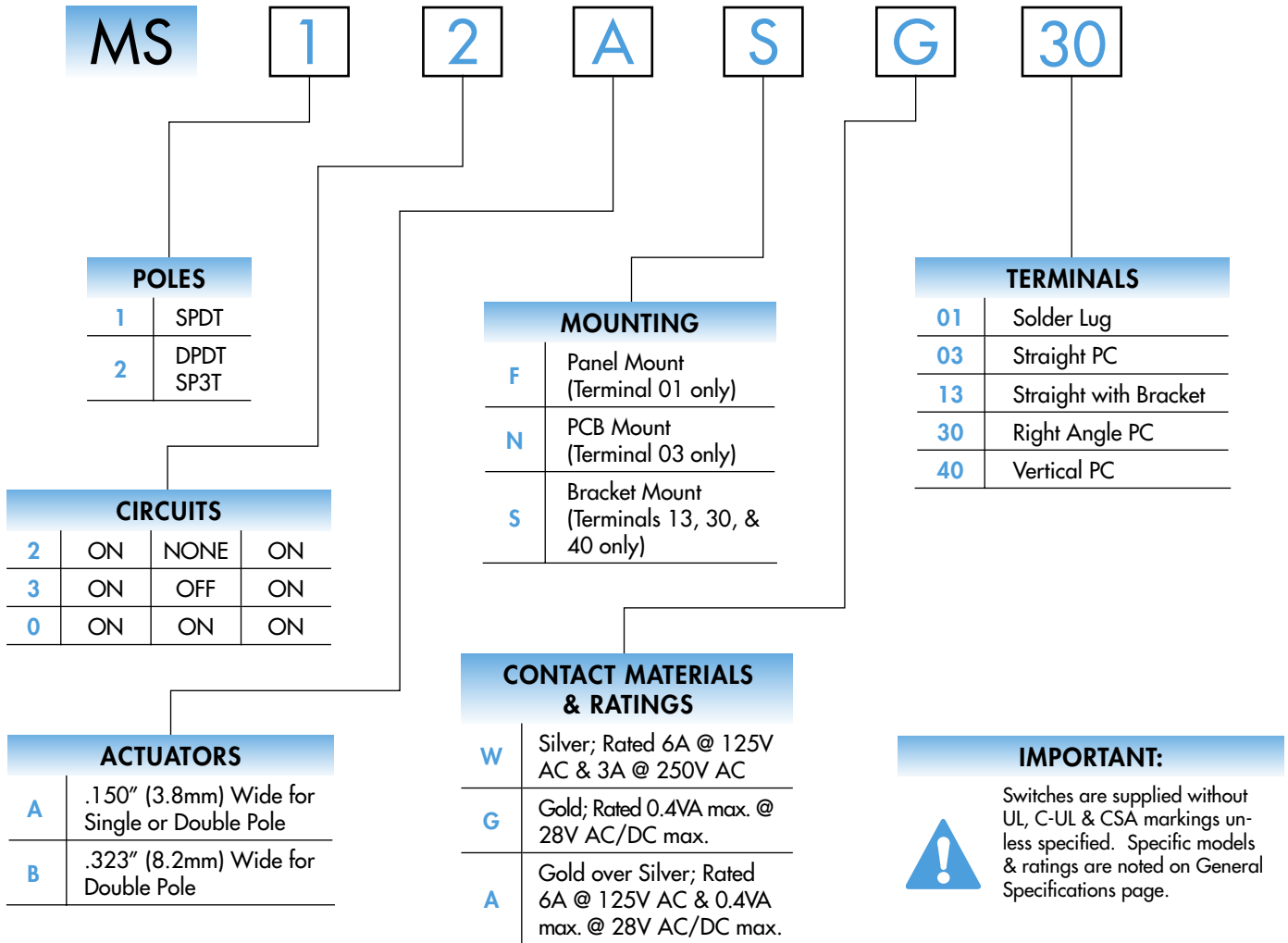

DESCRIPTION FOR TYPICAL ORDERING EXAMPLE

MS12ASG30

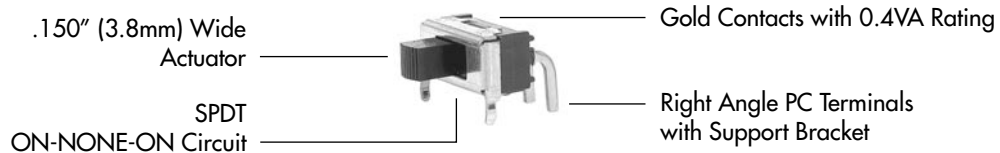

POLES & CIRCUITS

Pole	Model	Slide Position			Connected Terminals			Throw & Schematics
		Left	Center	Right	Left	Center	Right	
								Note: Terminal numbers are not actually on the switch.
SP	MS12 MS13	ON ON	NONE OFF	ON ON	2-1	OPEN	2-3	SPDT
DP	MS22 MS23	ON ON	NONE OFF	ON ON	2-1 5-4	OPEN	2-3 5-6	DPDT

For 3 Throw (3-On)

Pole	Model	Connected Terminals & Schematics			External Connection
		Left	Center	Right	
SP	MS20	ON 2-1 5-4	ON 2-3 5-4	ON 2-3 5-6	The SP3T model utilizes a double pole base. External connections must be made during field installation.

ACTUATORS

A .150" (3.8mm) Wide for Single Pole

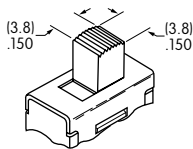

.150" (3.8mm) Wide for Double Pole

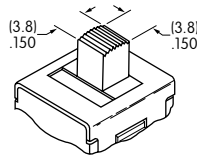

B .323" (8.2mm) Wide for Double Pole Only

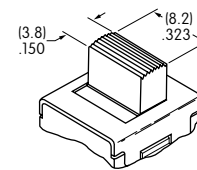

CONTACT MATERIALS & RATINGS

W Silver over Silver Power Level 6A @ 125V AC & 3A @ 250V AC

G Gold over Brass or Copper Logic Level 0.4VA maximum @ 28V AC/DC maximum
Note: Complete explanation of operating range in Supplement section.

A Gold over Silver Power Level or Logic Level 6A @ 125V AC or 0.4VA maximum @ 28V AC/DC maximum

Note: This dual rated option is suitable when two or more identical switches are used in logic and in power circuits within the same application. See Supplement section for complete explanation of dual rating and operating range.

MOUNTING TYPES & TERMINALS

F Panel Mount
(Combines with Solder Lug Terminal 01 only)



Dimension A =
.268" (6.8mm) for on-none-on
.319" (8.1mm) for on-off-on & on-on-on

Maximum Panel Thickness: .197" (5.0mm)

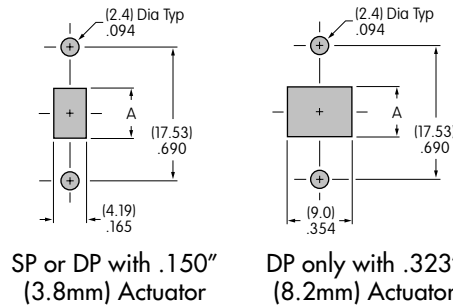

N Straight PC Mount
(Combines with Straight PC Terminal 03 only)



S Support Bracket Mount
(For Terminals 13, 30, & 40)

Maximum Panel Thickness:
For Straight PC with Bracket Terminal 13: .197" (5.0mm)
For Angle Mount Terminals 30 & 40: .177" (4.5mm)



01 Solder Lug

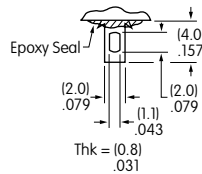

03 Straight PC

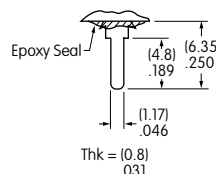

13 Straight PC with Bracket

30 Right Angle PC

40 Vertical PC

TYPICAL SWITCH DIMENSIONS

Solder Lug Terminals



MS12AFW01

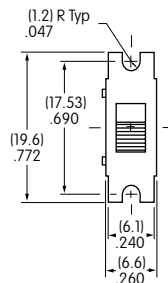

Single Pole

Actuator in LEFT Position

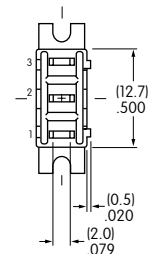
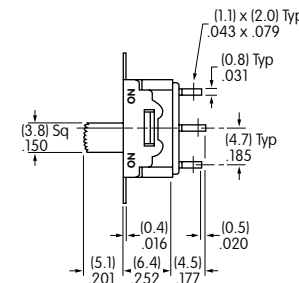

Solder Lug Terminals



MS22BFW01

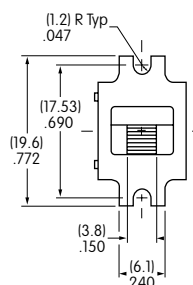

Double Pole

Actuator in LEFT Position

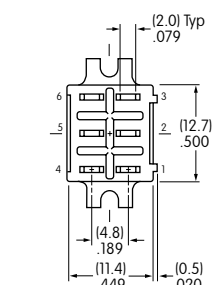
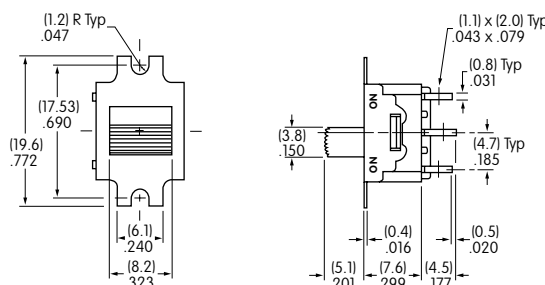

TYPICAL SWITCH DIMENSIONS

Straight PC Terminals

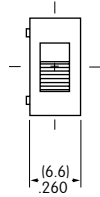

Single Pole

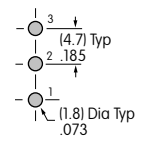
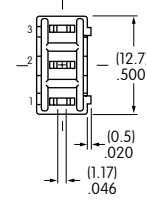
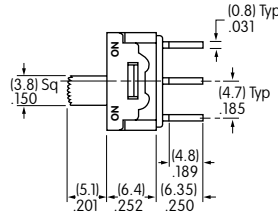

MS12ANG03

Actuator in LEFT Position

Straight PC Terminals

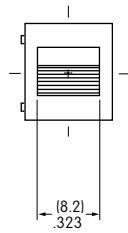
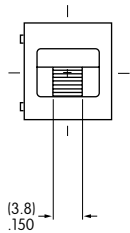

Double Pole

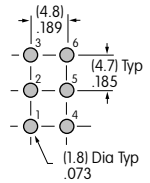
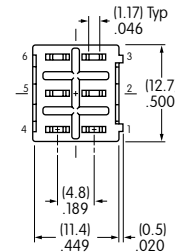
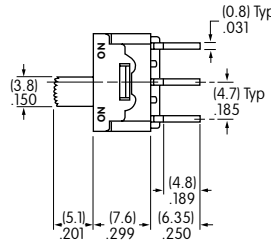

MS22BNG03

Actuator in LEFT Position

Straight PC Terminals with Bracket

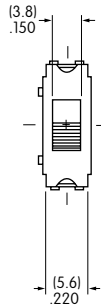

Single Pole

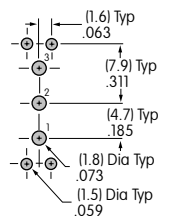
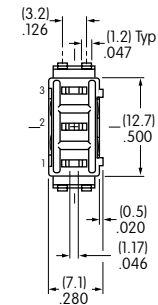
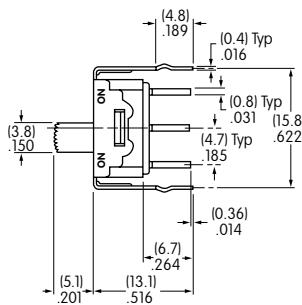

MS12ASG13

Actuator in LEFT Position

Straight PC Terminals with Bracket

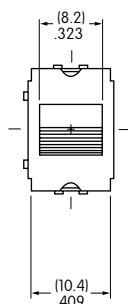
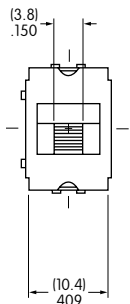

Double Pole

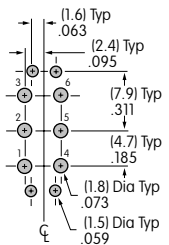
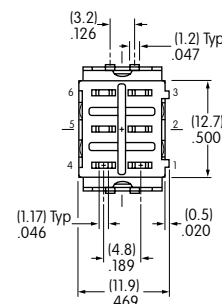
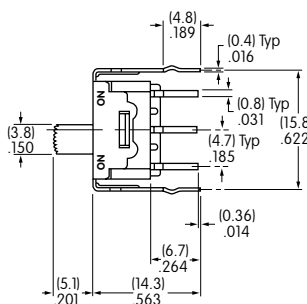

MS22BSG13

Actuator in LEFT Position

TYPICAL SWITCH DIMENSIONS

Right Angle PC Terminals

Single Pole

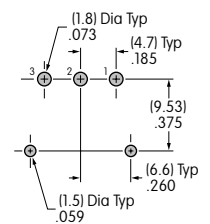
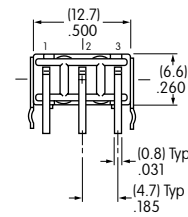
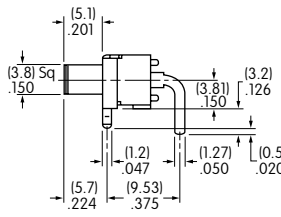
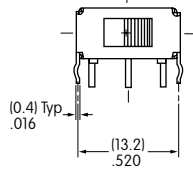

MS12ASG30

Actuator in LEFT Position

Right Angle PC Terminals

Double Pole

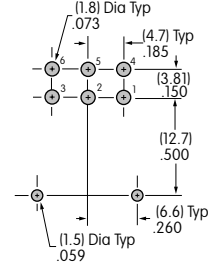
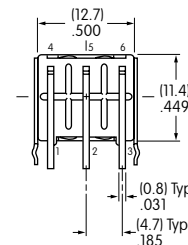
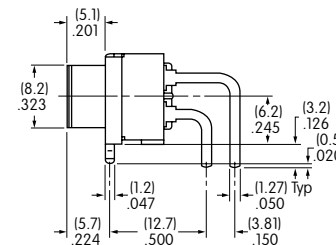
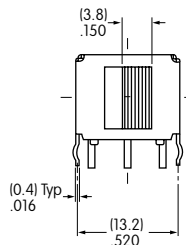
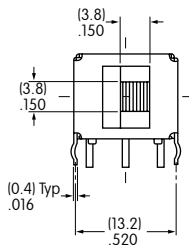

MS22BSG30

Actuator in LEFT Position

Vertical PC Terminals

Single Pole

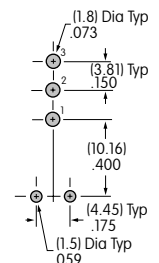
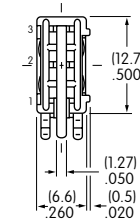
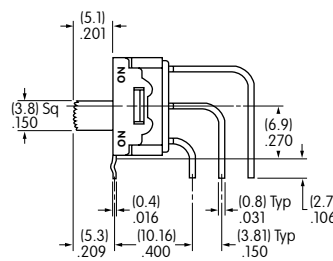
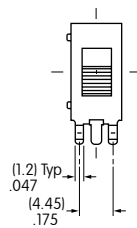

MS12ASG40

Actuator in LEFT Position

Vertical PC Terminals

Double Pole

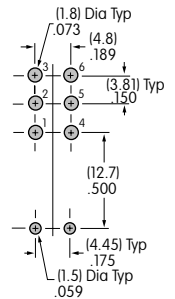
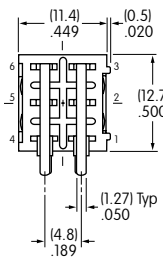
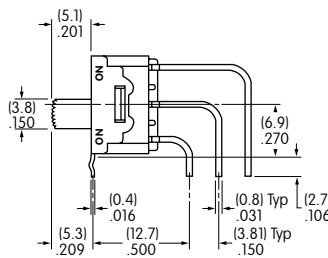
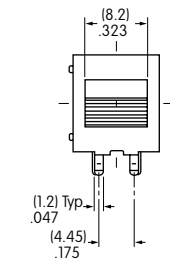
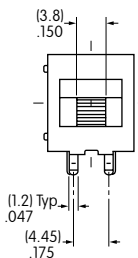

MS22BSG40

Actuator in LEFT Position