



RF3619D

**404.0 MHz
SAW Filter**

- 402 to 405 MHz Medical Band Front-end Filter
- Single-ended Input/Output Operation
- Complies with Directive 2002/95/EC (RoHS) 

Absolute Maximum Ratings

Rating	Value	Units
Input Power Level	+10	dBm
DC Voltage on any Non-ground Pin	3	V
Operating Temperature Range	-10 to +60	°C
Storage Temperature Range in Tape and Reel	-40 to +85	°C
Solder Reflow Temperature, 10 seconds, 5 cycles maximum	260	°C

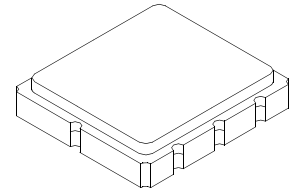

**SM3838-8 Case
3.8 x 3.8**

Electrical Characteristics

Characteristic	Sym	Notes	Minimum	Typical	Maximum	Units
Center Frequency at 25 °C	f_c	1, 2, 3		404.0		MHz
Insertion Loss	IL_{MIN}	1, 3		2.1	2.3	dB
Passband Ripple, 402-405 MHz		1, 3		0.6	0.8	dB
3 dB Bandwidth	BW_3	1	5.0	6.0		MHz
Attenuation relative to IL_{MIN} :						
398.5 MHz		1, 3		30	35	dB
408.5 MHz				25	45	
383.5 MHz				40	50	
423.5 MHz				38	48	
Freq. Temp. Coefficient	FTC			-37		ppm/k
Frequency Aging, First Year	$ fA $	5		≤10		ppm
Single-ended Input/Output Impedance Match		1		50		ohms
Differential Input/Output Impedance Match		1		150		ohms
Lid Symbolization (Y=year WW=week S=shift)	A15, YWWS					
Standard Reel Quantity	Reel Size 7 Inch	9	500 Pieces/Reel			
	Reel Size 13 Inch		3000 Pieces/Reel			



CAUTION: Electrostatic Sensitive Device. Observe precautions for handling.

Notes:

1. Unless noted otherwise, all measurements are made with the filter installed in the specified test fixture which is connected to a 50 Ω test system.
2. The frequency f_c is defined as the midpoint between the 3 dB frequencies.
3. Where noted specifications apply over the entire specified operating temperature range of -10 °C to +60 °C.
4. Frequency aging is the change in f_c with time and is specified at +65 °C or less. Aging may exceed the specification for prolonged temperatures above +65 °C. Typically, aging is greatest the first year after manufacture, decreasing significantly in subsequent years.
5. The design, manufacturing process, and specifications of this device are subject to change.
6. One or more of the following U.S. Patents apply: 4,54,488, 4,616,197, and others pending.
7. All equipment designs utilizing this product must be approved by the appropriate government agency prior to manufacture or sale.
8. Tape and Reel Standard Per ANSI / EIA 481.
9. This product complies with Directive 2002/95/EC of the European Parliament and of the Council of 27 January 2003 on the restriction of the use of certain hazardous substances in electrical and electronic equipment.

Filter Response Plots

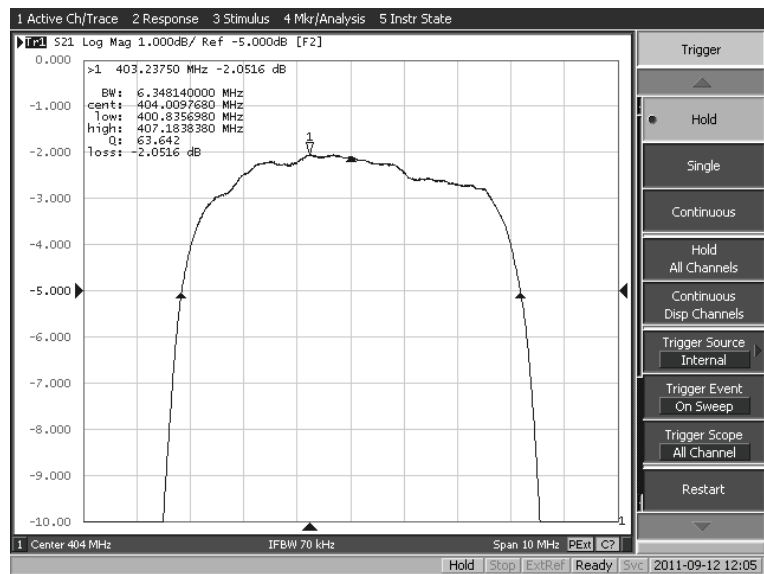
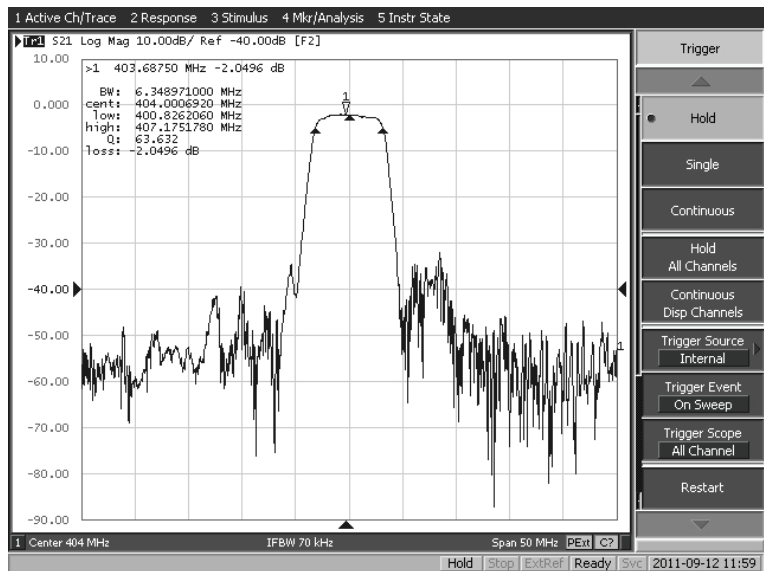
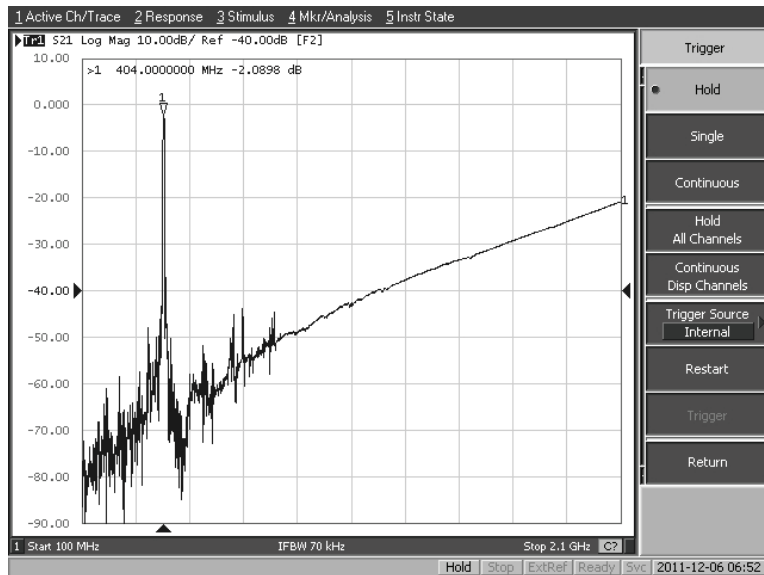

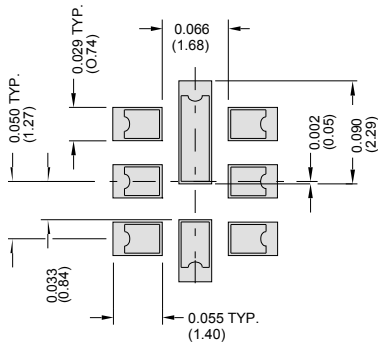

PCB Land Pattern
Filter Primary
Electrical Connections

Pin	Connection
1	Ground
2	Ground
3	Input
4	Ground
5	Ground
6	Ground
7	Output
8	Ground

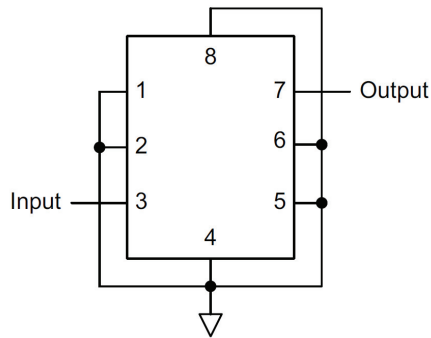

Single-ended
Input and Output
Filter Primary
Connection Diagram

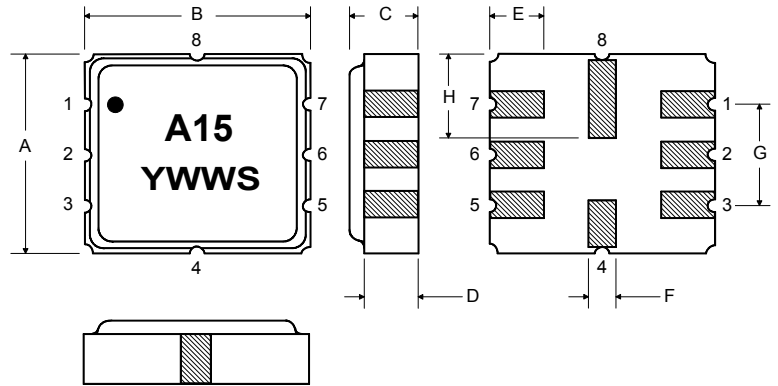

Case Dimensions

Dimension	mm			Inches		
	Min	Nom	Max	Min	Nom	Max
A	3.6	3.8	4.0	0.14	0.15	0.16
B	3.6	3.8	4.0	0.14	0.15	0.16
C	1.00	1.20	1.40	0.04	0.05	0.055
D	0.95	1.10	1.25	0.033	0.043	0.05
E	0.90	1.0	1.10	0.035	0.04	0.043
F	0.50	0.6	0.70	0.020	0.024	0.028
G	2.39	2.54	2.69	0.090	0.100	0.110
H	1.40	1.75	2.05	0.055	0.069	0.080

Filter Alternate
Electrical Connections

Pin	Connection
1	Ground
2	Input
3	Ground
4	Ground
5	Ground
6	Output
7	Ground
8	Ground

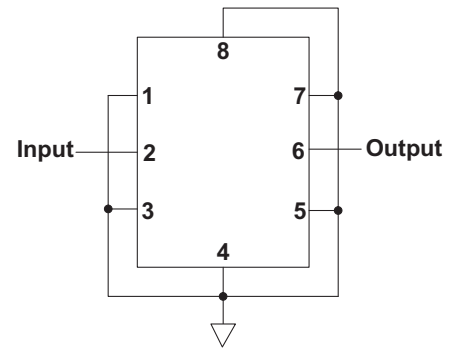

Single-ended
Input and Output
Filter Alternate
Connection Diagram