

For more information on our new products or for technical support you can:

Call us:
800-284-7007

Send e-mail to:
teledyne_relays@teledyne.com

Visit:
teledynereleys.com

New Products

Solid State Relays

Industrial Ultra Miniature Power Relay

- **Series FS:** Output to 20A 240Vac; DC Control, Zero cross for reduced inrush, Ultra miniature package: 30% smaller than most relays at same current rating, Faston or PIN Terminals

High Voltage, Short Circuit Protected DIP SSR

- **Series SR75-3:** 0.5 Amp, 400 Vdc 16 pin DIP

Surface Mount Leadless Chip Carriers

- **Series SED:** 1 Amp, 28 Vdc, Optically Isolated Thermally Protected
- **Series SGD:** 2 Amp, 28 Vdc, Optically Isolated Thermally Protected

Quad Short Circuit Protected SSR

- **Series SJD:** 250 mA, 28 Vdc, Quad Optically Isolated

Electromechanical Relays

Force Guided Fail Safe Power Electromechanical Relays

- **SAFET² FORCE GUIDED SAFETY RELAYS:** Teledyne's new line of SafeT² Electro-mechanical Power Relays help prevent damage to equipment and, more importantly, people. These relays, available in eight different families, are designed with force-guided contact sets to fail in a predicted mode. They are rugged, handle up to 10 amps, and offer outstanding dielectric strength.

Magnetic Latching, High Isolation

- **RF341:** Magnetic Latching, characterized to 5 GHz, High Isolation, Stable Insertion loss, low VSWR, in a TO-5 package for use in hostile environments



HIGH REPEATABILITY ULTRAMINIATURE T0-5, RF BYPASS RELAY DC TO 3 GHz

**SERIES
RF320
RF323**

SERIES DESIGNATION	RELAY TYPE
RF320	Repeatable, RF, N.O. Bypass relay
RF323	Sensitive repeatable, RF, N.O. Bypass relay

INTERNAL CONSTRUCTION

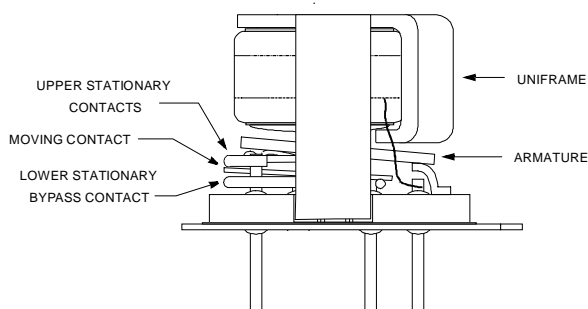

PERFORMANCE FEATURES

The ultraminiature RF320 and RF323 relays are designed with an internal bypass (through path), when the coil is energized, to provide low insertion loss and VSWR through the bypass and simplicity of design for the user. Relays have improved RF insertion loss repeatability over the frequency range from dc to 3 GHz. Highly suitable for use in attenuator, linear amplifier and other RF circuits. The RF 320 and RF323 feature:

- N.O. bypass configuration.
- Repeatable insertion loss.
- Broad bandwidth.
- Metal enclosure for EMI shielding.
- Ground pin option to improve case grounding.
- High isolation between control and signal paths.
- High resistance to ESD.

ENVIRONMENTAL AND PHYSICAL SPECIFICATIONS

Temperature	-55 °C to +85 °C	
Vibration (General Note 1)	10 G to 500 Hz	
Shock (General Note 1)	30 G, 6 ms., half sine	
Enclosure	Hermetically sealed	
Weight	RF320	0.09 oz. (2.55 g) max.
	RF323	0.16 oz. (4.50 g) max.

CONSTRUCTION FEATURES

The following unique construction features and manufacturing techniques provide excellent resistance to environmental extremes and overall high reliability.

- Uni-frame motor design provides high magnetic efficiency and mechanical rigidity.
- Minimum mass components and welded construction provide maximum resistance to shock and vibration.
- Advanced cleaning techniques provide maximum assurance of internal cleanliness.
- Gold plated precious metal alloy contacts ensure reliable switching.

SERIES RF320 and RF323

TYPICAL RF CHARACTERISTICS (Notes 1, 2 and 3)

INSERTION LOSS AND VSWR CHARACTERISTICS RF320 RELAYS

TYPICAL CHARACTERISTICS FOR N.C. CONTACTS, PER POLE, COIL DE-ENERGIZED (NOTES 3 AND 4)

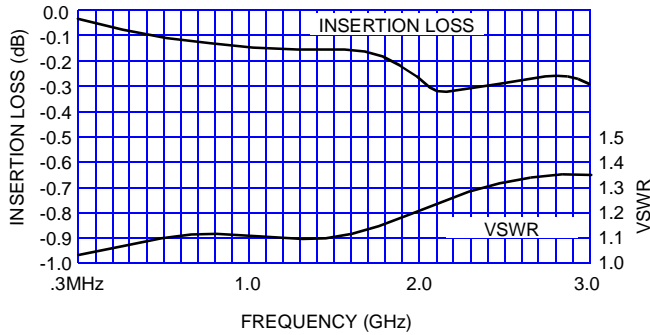

TYPICAL CHARACTERISTICS FOR N.O. BYPASS PATH, COIL ENERGIZED

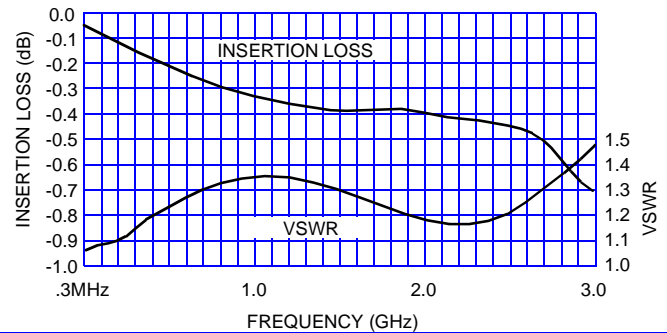

INSERTION LOSS AND VSWR CHARACTERISTICS RF323 RELAYS

TYPICAL CHARACTERISTICS FOR N.C. CONTACTS, PER POLE, COIL ENERGIZED (NOTES 3 AND 4)

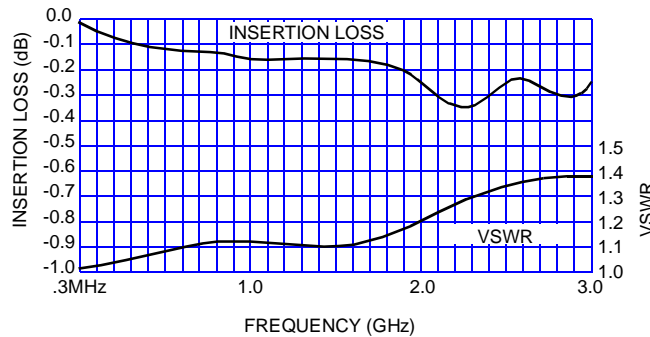

TYPICAL CHARACTERISTICS FOR N.O. BYPASS PATH, COIL DE-ENERGIZED

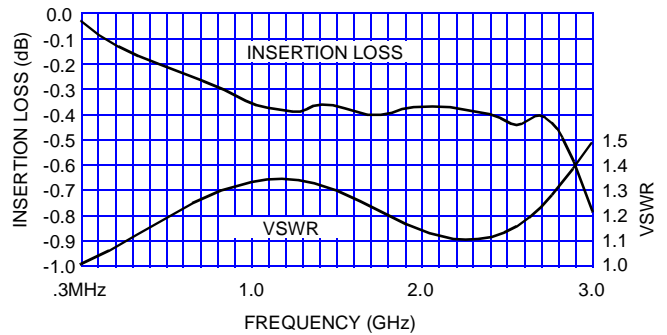

ISOLATION CHARACTERISTICS RF320 AND RF323 RELAYS

ISOLATION POLE TO POLE (COIL DE-ENERGIZED) (NOTE 5)

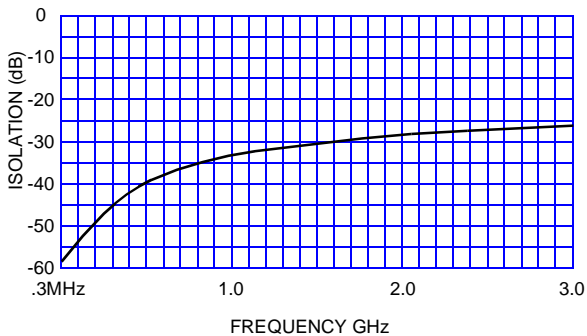

ISOLATION N.C. CONTACT TO N.O. BYPASS PATH (COIL ENERGIZED) (NOTE 6)

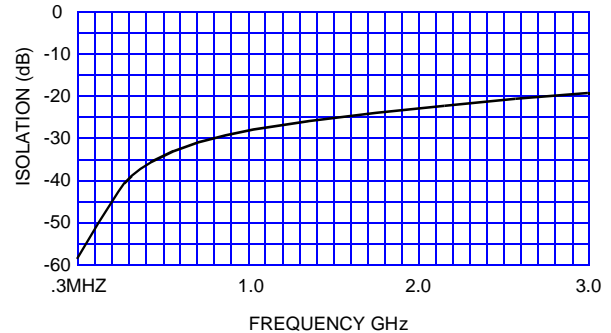

RF Characteristics Notes:

- Test conditions:
 - Fixture: .031" copper clad, reinforced PTFE, duroid 6002[®] with SMA connectors. (Duroid is a registered trademark of Rogers Corporation).
 - Relays header is not soldered to ground plane nor connected to ground via ground pin.
 - Test performed at room ambient temperature.
 - Terminals not tested were terminated with 50 ohm load.
 - Contact signal level: 0 dBm.
- Data presented herein represents typical characteristics and is not intended to be used as specification limits.
- Data is per pole.
- Measurement points are from pins 2 & 4 to pins 6 & 8.
- Data is the average of both N.C. contacts to the bypass path.
- Relays operate at frequencies above 3 GHz with reduced RF performance characteristics.

SERIES RF320 and RF323

TYPICAL INSERTION LOSS REPEATABILITY CHARACTERISTICS

REPEATABILITY CHARACTERISTICS RF320

TYPICAL REPEATABILITY DATA, N.C. CONTACT

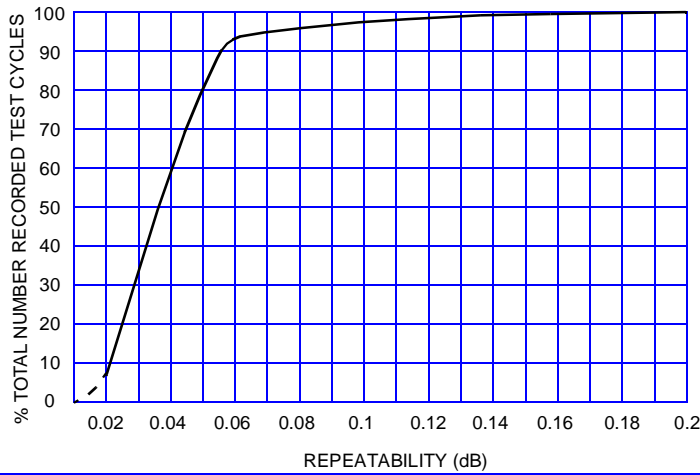

TYPICAL REPEATABILITY DATA, BYPASS

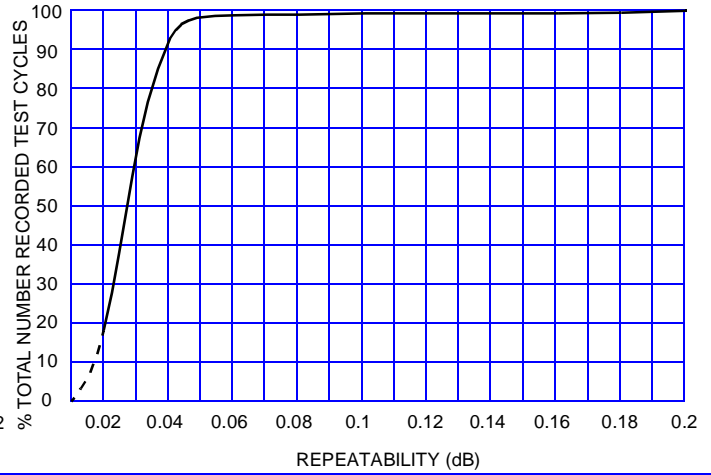

REPEATABILITY CHARACTERISTICS RF323

TYPICAL REPEATABILITY DATA, N.C. CONTACT

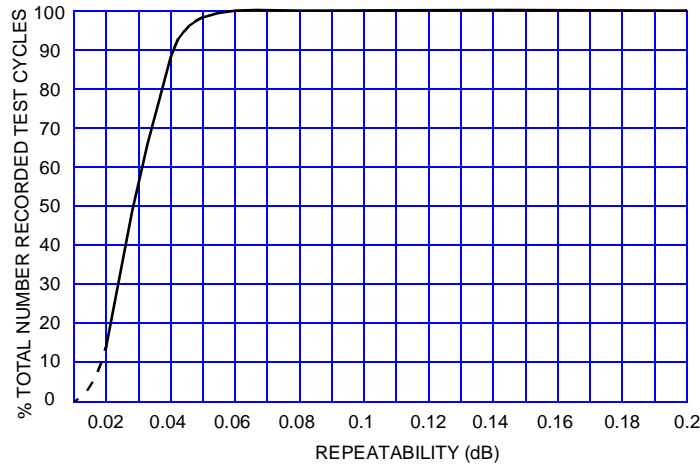

TYPICAL REPEATABILITY DATA, BYPASS

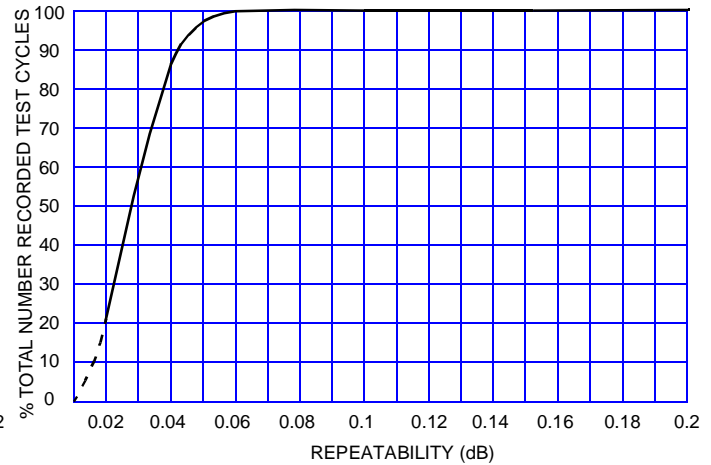

RF Insertion Loss Repeatability Notes

1. Test conditions: *a.* Fixture: .031" copper clad, reinforced PTFE, duroid 6002[®] with SMA connectors. (Duroid is a registered trademark of Rogers Corporation).
b. Relay header not soldered to ground plane nor connected via ground pin.
c. Test performed at room ambient temperature.
d. Contact signal level: 0 dBm.
2. Data presented herein represents typical characteristics and is not intended to be used as specification limits.
3. N.C. path contacts connected in series externally.
4. Insertion loss repeatability measured over frequency range from .3 MHz to 3 GHz.

SERIES RF320 and RF323

GENERAL ELECTRICAL SPECIFICATIONS (@25°C)

Contact arrangement	N.C. side (coil de-energized)	N.O. side (coil energized)
	DPST, Normally Closed	SPST, Normally Open Double Make
Rated duty	Continuous	
Contact resistance (General note 2)	0.15 ohm max. initial (measured 1/8" from the header)	
Contact load rating	Low level: 10 to 50 μ A, 10 to 50 mV	
Contact life rating	10,000,000 cycles typical at low level	
Coil operating power	RF320: 450 mW typical @ nominal rated voltage RF323: 200 mW typical @ nominal rated voltage	
Operate time	RF320	4.0 ms. max.
	RF323	6.0 ms. max.
Release time	RF320	3.0 ms. max.
	RF323	3.0 ms. max.
Intercontact capacitance	0.4 pF typical	
Insulation resistance	1,000 M Ω min. (between mutually isolated terminals)	
Dielectric strength	350 VRMS / 60 Hz @ atmospheric pressure	

DETAILED ELECTRICAL SPECIFICATIONS (@ 25°C)

BASE PART NUMBERS	RF320-5 RF323-5	RF320-12 RF323-12
Coil voltage, nominal, VDC	5.0	12.0
Coil resistance, ohms \pm 20%	RF320	50
	RF323	100
Pick-up voltage max, VDC	3.6	9.0

OUTLINE DIMENSIONS

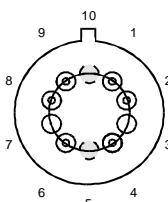

TERMINAL NUMBERING

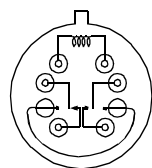

SCHEMATIC

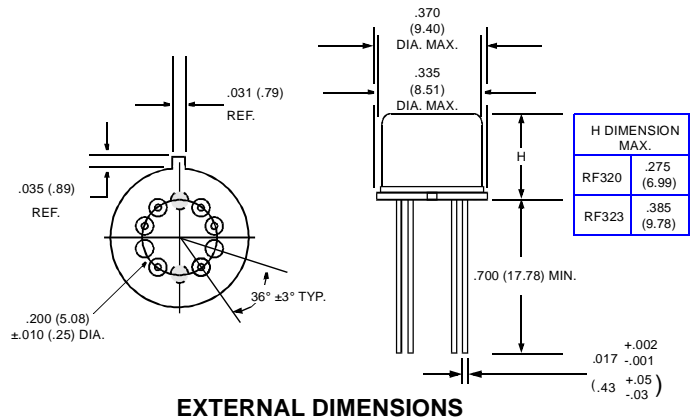

EXTERNAL DIMENSIONS

- HEADER DIMENSIONS, TERMINAL NUMBERING AND SCHEMATIC ARE AS VIEWED FROM THE TERMINALS.
- DIMENSIONS ARE IN INCHES (MILLIMETERS).
- POSITIONS 5 AND 10 ARE FOR UNINSULATED CASE GROUND OPTIONS.
- NO PROTRUSION BELOW BOTTOM OF HEADER WHEN GROUND PINS ARE INSTALLED IN POSITIONS 5 OR 10.
- SCHEMATIC AND EXTERNAL DIMENSIONS SHOWN WITHOUT GROUND PINS.
- TO ORDER THE CASE GROUND OPTION, AFTER THE SERIES DESIGNATOR, ADD "Y" TO THE PART NUMBER FOR POSITION 5 OR "Z" TO THE PART NUMBER FOR POSITION 10.

EXAMPLE: RF3##Y-COIL VOLTAGE

GENERAL NOTES

1. Relays exhibit no contact chatter in excess of 10 μ s or transfer in excess of 1 μ s.
2. Contact resistance value applies to each closed contact as well as the bypass path.

©1997

TELEDYNE RELAYS
12525 Daphne Ave.
Hawthorne, CA 90250
(213) 777-0077
<http://www.teledynereleys.com>